

AYDINLATMA ÜRÜNLERİ KATALOĐU

LIGHTING
PRODUCTS CATALOG

2023



borled[®]
by **borsan**

AYDINLATMA ÜRÜNLERİ KATALOĐU

LIGHTING
PRODUCTS CATALOG

2023



01.02.2023

Ürün Kodu Product Code	Güç (W) Power	Sayfa No Page No
---------------------------	------------------	---------------------

SLIM LED ARMATÜR
SLIM LED ARMATURE

BL-S1-2001	3W	10
BL-S1-2002	3W	10
BL-S1-2003	3W	10
BL-S1-2004	6W	10
BL-S1-2005	6W	10
BL-S1-2006	6W	10
BL-S1-2009	9W	10
BL-S1-2008	9W	10
BL-S1-2009	9W	10
BL-S1-2010	12W	10
BL-S1-2011	12W	10
BL-S1-2012	12W	10
BL-S1-2013	15W	10
BL-S1-2014	15W	10
BL-S1-2015	15W	10
BL-S1-2016	18W	10
BL-S1-2019	18W	10
BL-S1-2018	18W	10
BL-S1-2019	24W	10
BL-S1-2020	24W	10
BL-S1-2021	24W	10
BL-S1-2022	18W	10
BL-S1-2023	18W	10
BL-S1-2024	18W	10
BL-S1-2025	24W	10
BL-S1-2026	24W	10
BL-S1-2029	24W	10

SIVA ÜSTÜ LED PANEL ARMATÜR
SURFACE MOUNTED LED PANEL

BL-S2-2013	15W	12
BL-S2-2014	15W	12
BL-S2-2015	15W	12
BL-S2-2016	18W	12
BL-S2-2019	18W	12
BL-S2-2018	18W	12
BL-S2-2019	24W	12
BL-S2-2020	24W	12
BL-S2-2021	24W	12
BL-S2-2013	15W	12
BL-S2-2013	15W	12
BL-S2-2014	15W	12
BL-S2-2015	15W	12
BL-S2-2016	18W	12
BL-S2-2019	18W	12
BL-S2-2018	18W	12
BL-S2-2019	24W	12
BL-S2-2020	24W	12
BL-S2-2021	24W	12

Ürün Kodu Product Code	Güç (W) Power	Sayfa No Page No
---------------------------	------------------	---------------------

BACKLIGHT DOWNLIGHT ARMATÜR
BACKLIGHT DOWNLIGHT ARMATURE

BL-BD-0001	10W	14
BL-BD-0002	10W	14
BL-BD-0003	10W	14
BL-BD-0004	15W	14
BL-BD-0005	15W	14
BL-BD-0006	15W	14
BL-BD-0007	20W	14
BL-BD-0008	20W	14
BL-BD-0009	20W	14
BL-BD-0010	30W	14
BL-BD-0011	30W	14
BL-BD-0012	30W	14

BETA BACKLIGHT DOWNLIGHT
BETA BACKLIGHT DOWNLIGHT

BL-BD-2001	8W	16
BL-BD-2002	8W	16
BL-BD-2003	8W	16
BL-BD-2004	10W	16
BL-BD-2005	10W	16
BL-BD-2006	10W	16
BL-BD-2007	15W	16
BL-BD-2008	15W	16
BL-BD-2009	15W	16
BL-BD-2010	18W	16
BL-BD-2011	18W	16
BL-BD-2012	18W	16
BL-BD-2013	25W	16
BL-BD-2014	25W	16
BL-BD-2015	25W	16
BL-BD-2016	30W	16
BL-BD-2017	30W	16
BL-BD-2018	30W	16

COB LED ARMATÜR
COB LED ARMATURE

BL-COB1-0001	7W	18
BL-COB1-0002	7W	18
BL-COB1-0003	7W	18
BL-COB1-0004	9W	18
BL-COB1-0005	9W	18
BL-COB1-0006	9W	18
BL-COB1-0007	12W	18
BL-COB1-0008	12W	18
BL-COB1-0009	12W	18
BL-COB1-0010	25W	18
BL-COB1-0011	25W	18
BL-COB1-0012	25W	18
BL-COB1-0013	30W	18
BL-COB1-0014	30W	18
BL-COB1-0015	30W	18

Ürün Kodu Product Code	Güç (W) Power	Sayfa No Page No
---------------------------	------------------	---------------------

GU10 DUYLU SPOT
GU10 SPOT

BL-GU-1001	220-230 V AC	20
BL-GU-1002	220-230 V AC	20
BL-GU-1003	220-230 V AC	20
BL-GU-1004	220-230 V AC	20
BL-GU-2001	220-230 V AC	20
BL-GU-2002	220-230 V AC	20
BL-GU-2003	220-230 V AC	20
BL-GU-2004	220-230 V AC	20

SIVA ÜSTÜ GU10 DUYLU ARMATÜR
SURFACE FITTING GU10 ARMATURE

BL-GU-1005	GU-10	22
BL-GU-1006	GU-10	22
BL-GU-1007	GU-10	22
BL-GU-1008	GU-10	22

RAY SPOT GU10 DUYLU ARMATÜR

BL-GU-1010	220-230 V AC	24
BL-GU-1011	220-230 V AC	24

LED FRAMELESS DOWNLIGHT ARMATÜR
LED FRAMELESS DOWNLIGHT ARMATURE

BL-D1-0001	9W	26
BL-D1-0002	9W	26
BL-D1-0003	9W	26
BL-D1-0004	18W	26
BL-D1-0005	18W	26
BL-D1-0006	18W	26
BL-D1-0007	24W	26
BL-D1-0008	24W	26
BL-D1-0009	24W	26
BL-D1-0010	36W	26
BL-D1-0011	36W	26
BL-D1-0012	36W	26

SLIM LED PANEL ARMATÜR
SLIM LED PANEL ARMATURE

BL-O5-2001	40W	28
BL-O5-2002	40W	28
BL-O5-2003	40W	28
BL-O8-0001	24W	28
BL-O8-0002	24W	28
BL-O8-0003	24W	28
BL-O6-2001	24W	28
BL-O6-2002	24W	28
BL-O6-2003	24W	28
BL-O7-2001	48W	28
BL-O7-2002	48W	28
BL-O7-2003	48W	28

LED OPAL LENS SLIM BACKLIGHT ARMATÜR
LED SLIM BACKLIGHT ARMATURE - OPAL LENS

BL-O2-3008	15W	30
BL-O2-3009	15W	30
BL-O2-3010	15W	30

Ürün Kodu Product Code	Güç (W) Power	Sayfa No Page No
BL-O2-2011	40W	30
BL-O2-2012	40W	30
BL-O2-2013	40W	30
BLT-O2-3008	15W	32
BLT-O2-3009	15W	32
BLT-O2-3010	15W	32
BLT-O2-2011	40W	32
BLT-O2-2012	40W	32
BLT-O2-2013	40W	32
LED OPAL LENSİLİ BACKLIGHT ARMATÜR LED BACKLIGHT ARMATURE - OPAL LENS		
BLT-O2-2005	12W	34
BLT-O2-2006	12W	34
BLT-O6-0002	24W	34
BLT-O6-0003	24W	34
BLT-O2-2002	36W	34
BLT-O2-2003	36W	34
BLT-O5-2005	12W	34
BLT-O5-2006	12W	34
BLT-O6-1002	24W	34
BLT-O6-1003	24W	34
BLT-O5-2008	36W	34
BLT-O5-2009	36W	34
BLT-O2-3011	12W	34
BLT-O2-3012	12W	34
BLT-O6-2002	24W	34
BLT-O6-2003	24W	34
BLT-O2-2008	36W	34
BLT-O2-2009	36W	34
LED BACKLIGHT STERİL ORTAM ARMATÜR LED BACKLIGHT STERILE AMBIENT ARMATURE		
BL-O2-3001	15W	36
BL-O2-3002	15W	36
BL-O2-4001	35W	36
BL-O2-4002	35W	36
BL-O5-3001	15W	36
BL-O5-3002	15W	36
BL-O5-4001	35W	36
BL-O5-4002	35W	36
LED PROJEKTÖR PLATİN SERİSİ LED PROJECTOR PLATINUM SERIES		
BL-P2-0001	10W	38
BL-P2-0002	10W	38
BL-P2-0003	10W	38
BL-P2-0004	20W	38
BL-P2-0005	20W	38
BL-P2-0006	20W	38
BL-P2-0007	30W	38
BL-P2-0008	30W	38
BL-P2-0009	30W	38
BL-P2-0010	50W	38

Ürün Kodu Product Code	Güç (W) Power	Sayfa No Page No
BL-P2-0011	50W	38
BL-P2-0012	50W	38
BL-P2-0013	70W	38
BL-P2-0014	70W	38
BL-P2-0015	70W	38
BL-P2-0016	100W	38
BL-P2-0017	100W	38
BL-P2-0018	100W	38
BL-P2-0019	150W	38
BL-P2-0020	150W	38
BL-P2-0021	150W	38
BL-P2-0022	200W	38
BL-P2-0023	200W	38
BL-P2-0024	200W	38
SENSÖRLÜ LED PROJEKTÖR PLATİN SERİSİ SENSOR LED PROJECTOR PLATINUM SERIES		
BL-P2-0001-S	10W	40
BL-P2-0003-S	10W	40
BL-P2-0004-S	20W	40
BL-P2-0006-S	20W	40
BL-P2-0007-S	30W	40
BL-P2-0009-S	30W	40
BL-P2-0010-S	50W	40
BL-P2-0012-S	50W	40
YEŞİL LED PROJEKTÖR PLATİN SERİSİ GREEN LED PROJECTOR PLATINUM SERIES		
BL-P2-1GRN	10W	40
BL-P2-2GRN	20W	40
BL-P2-3GRN	30W	40
BL-P2-5GRN	50W	40
LED PROJEKTÖR GOLD SERİSİ LED PROJECTOR GOLD SERIES		
BL-P4-0001	10W	42
BL-P4-0003	10W	42
BL-P4-0004	20W	42
BL-P4-0006	20W	42
BL-P4-0007	30W	42
BL-P4-0009	30W	42
BL-P4-0010	50W	42
BL-P4-0012	50W	42
BL-P4-0013	70W	42
BL-P4-0015	70W	42
BL-P4-0016	100W	42
BL-P4-0018	100W	42
BL-P4-0019	150W	42
BL-P4-0021	150W	42
BL-P4-0022	200W	42
BL-P4-0024	200W	42
BL-P4-0025	300W	42
BL-P4-0027	300W	42
BL-P4-0028	400W	42
BL-P4-0030	400W	42

Ürün Kodu Product Code	Güç (W) Power	Sayfa No Page No
LED SOKAK AYDINLATMA ARMATÜRÜ LED STREET LIGHTING ARMATURE		
BL-C2-2001	60W	44
BL-C2-2007	60W	44
BL-C2-2002	60W	44
BL-C2-2003	90W	44
BL-C2-2008	90W	44
BL-C2-2004	90W	44
BL-C2-2005	120W	44
BL-C2-2009	120W	44
BL-C2-2006	120W	44
DEKORATİF BAHÇE AYDINLATMA DİREKLERİ DECORATIVE GARDEN LIGHTING POLES		
BR-BA004	Siyah	46
BR-BA005	Siyah	46
BR-BA006	Siyah	46
BR-BA007	Siyah	46
BR-BA004	Siyah	46
BR-BA005	Siyah	46
BR-BA006	Siyah	46
BR-BA007	Siyah	46
SOLAR SOKAK AYDINLATMA ARMATÜRÜ DECORATIVE GARDEN LIGHTING POLES		
BL-SP-0010	80W	48
BL-SP-0011	80W	48
BL-SP-0012	80W	48
BL-SP-0013	100W	48
BL-SP-0014	100W	48
BL-SP-0015	100W	48
LED RAY SPOT LED RAIL SPOT		
BL-RS-0001	40W	50
BL-RS-0002	40W	50
BL-RS-0003	40W	50
BL-RS-1001	40W	50
BL-RS-1002	40W	50
BL-RS-1003	40W	50
BL-RS-1004	20W	50
BL-RS-1005	20W	50
BL-RS-1006	20W	50
BL-RS-1007	20W	50
BL-RS-1008	20W	50
BL-RS-1009	20W	50
BR-RSA-0001		50
BR-RSA-0002		50
BR-RSA-0003		50
BR-RSA-0004		50
BR-RSA-0005		50
BR-RSA-0006		50
BR-RSA-0008		50
BR-RSA-0011		50

Ürün Kodu Product Code	Güç (W) Power	Sayfa No Page No
BR-RSA-0009		50
BR-RSA-0012		50
BR-RSA-0007		50
BR-RSA-0010		50
LED YÜKSEK TAVAN ARMATÜR LED HIGH CEILING ARMATURE		
BL-Y1-0001	55W	52
BL-Y1-0002	55W	52
BL-Y1-0003	55W	52
BL-Y1-0004	90W	52
BL-Y1-0005	90W	52
BL-Y1-0006	90W	52
BL-Y1-0007	110W	52
BL-Y1-0008	110W	52
BL-Y1-0009	110W	52
BL-Y1-0010	135W	52
BL-Y1-0011	135W	52
BL-Y1-0012	135W	52
LED LINEER ARMATÜR LED LINEAR ARMATURE		
BL-L1-1001	15W	54
BL-L1-1002	15W	54
BL-L1-1003	20W	54
BL-L1-1004	20W	54
BL-L1-1005	30W	54
BL-L1-1006	30W	54
BL-L1-1007	40W	54
BL-L1-1008	40W	54
BL-L1-1009	45W	54
BL-L1-1010	45W	54
BL-L1-1011	50W	54
BL-L1-1012	50W	54
BL-L1-2001	15W	54
BL-L1-2002	15W	54
BL-L1-2003	20W	54
BL-L1-2004	20W	54
BL-L1-2005	30W	54
BL-L1-2006	30W	54
BL-L1-2007	40W	54
BL-L1-2008	40W	54
BL-L1-2009	45W	54
BL-L1-2010	45W	54
BL-L1-2011	50W	54
BL-L1-2012	50W	54
LENSLİ LINEER ARMATÜR LINEAR ARMATURE WITH LENS		
BL-L2-1001	20W	56
BL-L2-1002	20W	56
BL-L2-1003	50W	56
BL-L2-1004	50W	56
BL-L2-1011	20W	56
BL-L2-1012	20W	56

Ürün Kodu Product Code	Güç (W) Power	Sayfa No Page No
BL-L2-1013	50W	56
BL-L2-1014	50W	56
BL-L2-2001	20W	56
BL-L2-2002	20W	56
BL-L2-2003	50W	56
BL-L2-2004	50W	56
BL-L2-2011	20W	56
BL-L2-2012	20W	56
BL-L2-2013	50W	56
BL-L2-2014	50W	56
LED LEVEL ETANJ ARMATÜR LED LEVEL WATERPROOF ARMATURE		
BL-E1-0009	15W	58
BL-E1-0009-1H	15W	58
BL-E1-0009-3H	15W	58
BL-E1-0009-RS	15W	58
BL-E1-0009-RS-1H	15W	58
BL-E1-0009-RS-3H	15W	58
BL-E1-0013	15W	58
BL-E1-0013-1H	15W	58
BL-E1-0013-3H	15W	58
BL-E1-0013-RS	15W	58
BL-E1-0013-RS-1H	15W	58
BL-E1-0013-RS-3H	15W	58
BL-E1-0011	30W	58
BL-E1-0011-1H	30W	58
BL-E1-0011-3H	30W	58
BL-E1-0011-RS	30W	58
BL-E1-0011-RS-1H	30W	58
BL-E1-0011-RS-3H	30W	58
BL-E1-0015	30W	58
BL-E1-0015-1H	30W	58
BL-E1-0015-3H	30W	58
BL-E1-0015-RS	30W	58
BL-E1-0015-RS-1H	30W	58
BL-E1-0015-RS-3H	30W	58
LED LEVEL ETANJ ARMATÜR TSE LED LEVEL WATERPROOF ARMATURE TSE		
BLT-E1-0009	15W	60
BLT-E1-0009-1H	15W	60
BLT-E1-0009-3H	15W	60
BLT-E1-0009-RS	15W	60
BLT-E1-0009-RS-1H	15W	60
BLT-E1-0009-RS-3H	15W	60
BLT-E1-0013	15W	60
BLT-E1-0013-1H	15W	60
BLT-E1-0013-3H	15W	60
BLT-E1-0013-RS	15W	60
BLT-E1-0013-RS-1H	15W	60
BLT-E1-0013-RS-3H	15W	60
BLT-E1-0011	30W	60

Ürün Kodu Product Code	Güç (W) Power	Sayfa No Page No
BLT-E1-0011-1H	30W	60
BLT-E1-0011-3H	30W	60
BLT-E1-0011-RS	30W	60
BLT-E1-0011-RS-1H	30W	60
BLT-E1-0011-RS-3H	30W	60
BLT-E1-0015	30W	60
BLT-E1-0015-1H	30W	60
BLT-E1-0015-3H	30W	60
BLT-E1-0015-RS	30W	60
BLT-E1-0015-RS-1H	30W	60
BLT-E1-0015-RS-3H	30W	60
LED ELİPS ETANJ ARMATÜR LED ELIPS WATERPROOF ARMATURE		
BL-E1-0010	20W	62
BL-E1-0010-1H	20W	62
BL-E1-0010-3H	20W	62
BL-E1-0010-RS	20W	62
BL-E1-0010-RS-1H	20W	62
BL-E1-0010-RS-3H	20W	62
BL-E1-0014	20W	62
BL-E1-0014-1H	20W	62
BL-E1-0014-3H	20W	62
BL-E1-0014-RS	20W	62
BL-E1-0014-RS-1H	20W	62
BL-E1-0014-RS-3H	20W	62
BL-E1-0012	40W	62
BL-E1-0012-1H	40W	62
BL-E1-0012-3H	40W	62
BL-E1-0012-RS	40W	62
BL-E1-0012-RS-1H	40W	62
BL-E1-0012-RS-3H	40W	62
BL-E1-0016	40W	62
BL-E1-0016-1H	40W	62
BL-E1-0016-3H	40W	62
BL-E1-0016-RS	40W	62
BL-E1-0016-RS-1H	40W	62
BL-E1-0016-RS-3H	40W	62
LED ELİPS ETANJ ARMATÜR TSE LED ELIPS WATERPROOF ARMATURE TSE		
BLT-E1-0010	20W	64
BLT-E1-0010-1H	20W	64
BLT-E1-0010-3H	20W	64
BLT-E1-0010-RS	20W	64
BLT-E1-0010-RS-1H	20W	64
BLT-E1-0010-RS-3H	20W	64
BLT-E1-0014	20W	64
BLT-E1-0014-1H	20W	64
BLT-E1-0014-3H	20W	64
BLT-E1-0014-RS	20W	64
BLT-E1-0014-RS-1H	20W	64
BLT-E1-0014-RS-3H	20W	64
BLT-E1-0012	40W	64

Ürün Kodu Product Code	Güç (W) Power	Sayfa No Page No
BLT-E1-0012-1H	40W	64
BLT-E1-0012-3H	40W	64
BLT-E1-0012-RS	40W	64
BLT-E1-0012-RS-1H	40W	64
BLT-E1-0012-RS-3H	40W	64
BLT-E1-0016	40W	64
BLT-E1-0016-1H	40W	64
BLT-E1-0016-3H	40W	64
BLT-E1-0016-RS	40W	64
BLT-E1-0016-RS-1H	40W	64
BLT-E1-0016-RS-3H	40W	64

EX-PROOF LED ETANJ

EX-PROOF LED ETANJ

BL-EX-0001	20W	66
BL-EX-0002	20W	66
BL-EX-0003	20W	66
BL-EX-0004	40W	66
BL-EX-0005	40W	66
BL-EX-0006	40W	66
BL-EX-0007	60W	66
BL-EX-0008	60W	66
BL-EX-0009	60W	66

T5 LED TUBE ARMATÜR

T5 LED TUBE ARMATURE

BL-TB-0001	4W	68
BL-TB-0002	4W	68
BL-TB-0003	4W	68
BL-TB-0004	8W	68
BL-TB-0005	8W	68
BL-TB-0006	8W	68
BL-TB-0007	12W	68
BL-TB-0008	12W	68
BL-TB-0009	12W	68
BL-TB-0010	16W	68
BL-TB-0011	16W	68
BL-TB-0012	16W	68

AYNA ÜSTÜ ARMATÜR

ABOVE MIRROR ARMATURE

BL-AU-0001	12W	70
BL-AU-0002	12W	70
BL-AU-0003	12W	70
BL-AU-1001	24W	70
BL-AU-1002	24W	70
BL-AU-1003	24W	70

OVAL LED GLOP ARMATÜR

OVAL LED GLOBE ARMATURE

BL-G1-0002	12W	72
BL-G1-0002-1H	12W	72
BL-G1-0002-3H	12W	72
BL-G1-0002-RS	12W	72
BL-G1-0002-RS-1H	12W	72
BL-G1-0002-RS-3H	12W	72
BL-G1-0014	12W	72
BL-G1-0014-1H	12W	72

Ürün Kodu Product Code	Güç (W) Power	Sayfa No Page No
BL-G1-0014-3H	12W	72
BL-G1-0014-RS	12W	72
BL-G1-0014-RS-1H	12W	72
BL-G1-0014-RS-3H	12W	72
BL-G1-0008	12W	72
BL-G1-0008-1H	12W	72
BL-G1-0008-3H	12W	72
BL-G1-0008-RS	12W	72
BL-G1-0008-RS-1H	12W	72
BL-G1-0008-RS-3H	12W	72
BL-G1-0004	18W	72
BL-G1-0004-1H	18W	72
BL-G1-0004-3H	18W	72
BL-G1-0004-RS	18W	72
BL-G1-0004-RS-1H	18W	72
BL-G1-0004-RS-3H	18W	72
BL-G1-0016	18W	72
BL-G1-0016-1H	18W	74
BL-G1-0016-3H	18W	74
BL-G1-0016-RS	18W	74
BL-G1-0016-RS-1H	18W	74
BL-G1-0016-RS-3H	18W	74
BL-G1-0010	18W	74
BL-G1-0010-1H	18W	74
BL-G1-0010-3H	18W	74
BL-G1-0010-RS	18W	74
BL-G1-0010-RS-3H	18W	74
BL-G1-0006	24W	74
BL-G1-0006-1H	24W	74
BL-G1-0006-3H	24W	74
BL-G1-0006-RS	24W	74
BL-G1-0006-RS-1H	24W	74
BL-G1-0006-RS-3H	24W	74
BL-G1-0018	24W	74
BL-G1-0018-1H	24W	74
BL-G1-0018-3H	24W	74
BL-G1-0018-RS	24W	74
BL-G1-0018-RS-1H	24W	74
BL-G1-0018-RS-3H	24W	74
BL-G1-0012	24W	74
BL-G1-0012-1H	24W	74
BL-G1-0012-3H	24W	74
BL-G1-0012-RS	24W	74
BL-G1-0012-RS-1H	24W	74
BL-G1-0012-RS-3H	24W	74

FLAT LED GLOP ARMATÜR

FLAT LED GLOBE ARMATURE

BL-G1-0001	12W	76
BL-G1-0001-1H	12W	76
BL-G1-0001-3H	12W	76
BL-G1-0001-RS	12W	76
BL-G1-0001-RS-1H	12W	76
BL-G1-0001-RS-3H	12W	76

Ürün Kodu Product Code	Güç (W) Power	Sayfa No Page No
BL-G1-0013	12W	76
BL-G1-0013-1H	12W	76
BL-G1-0013-3H	12W	76
BL-G1-0013-RS	12W	76
BL-G1-0013-RS-1H	12W	76
BL-G1-0013-RS-3H	12W	76
BL-G1-0007	12W	76
BL-G1-0007-1H	12W	76
BL-G1-0007-3H	12W	76
BL-G1-0007-RS	12W	76
BL-G1-0007-RS-1H	12W	76
BL-G1-0007-RS-3H	12W	76
BL-G1-0003	18W	76
BL-G1-0003-1H	18W	76
BL-G1-0003-3H	18W	76
BL-G1-0003-RS	18W	76
BL-G1-0003-RS-1H	18W	76
BL-G1-0003-RS-3H	18W	76
BL-G1-0015	18W	76
BL-G1-0015-1H	18W	76
BL-G1-0015-3H	18W	76
BL-G1-0015-RS	18W	76
BL-G1-0015-RS-1H	18W	76
BL-G1-0015-RS-3H	18W	78
BL-G1-0009	18W	78
BL-G1-0009-1H	18W	78
BL-G1-0009-3H	18W	78
BL-G1-0009-RS	18W	78
BL-G1-0009-RS-1H	18W	78
BL-G1-0009-RS-3H	18W	78
BL-G1-0005	24W	78
BL-G1-0005-1H	24W	78
BL-G1-0005-3H	24W	78
BL-G1-0005-RS	24W	78
BL-G1-0005-RS-1H	24W	78
BL-G1-0005-RS-3H	24W	78
BL-G1-0017	24W	78
BL-G1-0017-1H	24W	78
BL-G1-0017-3H	24W	78
BL-G1-0017-RS	24W	78
BL-G1-0017-RS-1H	24W	78
BL-G1-0017-RS-3H	24W	78
BL-G1-0011	24W	78
BL-G1-0011-1H	24W	78
BL-G1-0011-3H	24W	78
BL-G1-0011-RS	24W	78
BL-G1-0011-RS-1H	24W	78
BL-G1-0011-RS-3H	24W	78

LED NEMLİYER GLOP TAVAN ARMATÜR

LED NEMLİYER GLOBE CEILING ARMATURE

BL-G2-0002	12W	80
BL-G2-0003	12W	80
BL-G2-0005	15W	80

Ürün Kodu Product Code	Güç (W) Power	Sayfa No Page No
BL-G2-0006	15W	80
BL-G2-0008	12W	80
BL-G2-0009	12W	80
BL-G2-0011	15W	80
BL-G2-0012	15W	80
BL-G3-0002	12W	80
BL-G3-0003	12W	80
BL-G3-0005	15W	80
BL-G3-0006	15W	80
BL-G3-0008	12W	80
BL-G3-0009	12W	80
BL-G3-0011	15W	80
BL-G3-0012	15W	80
SENSÖRLÜ GLOP LED GLOBE LED WITH SENSOR		
BL-G4-0001-S	12W	82
BL-G4-0002-S	12W	82
BL-G4-0003-S	12W	82
BL-G4-0004-S	15W	82
BL-G4-0005-S	15W	82
BL-G4-0006-S	15W	82
SENSÖRLÜ LED APLİK LED WALL LUMINAIRE WITH SENSOR		
BL-A1-0001-S	12W	82
BL-A1-0002-S	12W	82
BL-A1-0003-S	12W	82
BL-A1-0004-S	15W	82
BL-A1-0005-S	15W	82
BL-A1-0006-S	15W	82
LED TAVAN GLOP ARMATÜR LED CEILING GLOBE ARMATURE		
BL-B1-0007	12W	84
BL-B1-0008	12W	84
BL-B1-0009	11W	84
BL-B1-0010	11W	84
BL-B1-0011	11W	84
BL-B1-0012	11W	84
BL-B1-0015	24W	84
BL-B1-0016	24W	84
BL-B1-0017	24W	84
BL-B1-0018	24W	84
BL-B1-0019	12W	84
BL-B1-0020	12W	84
TAVAN ARMATÜR CEILING ARMATURE		
BL-B1-0021	12W	86
BL-B1-0022	12W	86
BL-B1-0024	12W	86
BL-B1-0025	12W	86
BR-00243-050	-	86
BR-10243 050	-	86
BR-C0243-050	-	86
BL-B1-0016	-	88
BL-B1-0015	-	88
BR-00203-000	12W	88
BR-00248-000	12W	88

Ürün Kodu Product Code	Güç (W) Power	Sayfa No Page No
BR-00203-010	15W	88
BR-00203-020	15W	88
BR-00248-010	12W	88
BR-00244-000	12W	88
BR-00244-010	15W	90
BR-00242-000	15W	90
BR-00242-010	12W	90
BR-00245-000	12W	90
BR-00245-010	15W	90
BR-00201-000	15W	90
BR-00201-010	15W	92
BR-00247-000	12W	92
BR-00247-010	12W	92
BR-00230-010	15W	92
BR-00230-000	15W	92
BR-00231-000	15W	92
TAVAN GLOP ARMATÜR CEILING GLOBE ARMATURE		
BR-00231-010	12W	94
BR-00231-020	12W	94
BR-00206-010	11W	94
BR-00206-000	11W	94
DUVAR APLİK ARMATÜR WALL LUMINAIRE		
BL-B1-0001	12W	96
BL-B1-0002	12W	96
BL-B1-0003	12W	96
BL-B1-0004	12W	96
BL-B1-0005	12W	96
BL-B1-0006	12W	96
BR-00309-000	-	98
BR-00235-000	-	98
BR-00306-000	-	98
BR-00307-000	-	98
BR-00246-000	-	98
BR-00246-010	-	98
BR-00249-000	-	100
BR-00220-000	-	100
BR-00220-001	-	100
BR-00220-010	-	100
BR-00220-011	-	100
BR-00222-000	-	100
BR-00222-001	-	100
LED ACİL ÇIKIŞ ARMATÜRÜ LED EMERGENCY EXIT LUMINAIRE		
BL-AC-0002	3W	102
BL-AC-0003	3W	102
BL-AC-0004	3W	102
BL-AC-0002	3W	104
BL-AC-0005	3W	104
BL-AC-0006	3W	104
BL-AC-0007	3W	104
BL-AC-0008	3W	104
BL-AC-0009	3W	104
BL-AC-0010	3W	104

Ürün Kodu Product Code	Güç (W) Power	Sayfa No Page No
DEDEKTÖR VE SENSÖRLER DETECTOR AND SENSORS		
BR-DD001	9V DC	106
BR-MS001	800W	106
BR-SA360	220-240V	106
BR-SU360	220-240V	106
BR-RS001	1200W	106
ŞERİT LED LED STRIP		
BL-NL-1001	14.4	108
BL-NL-1002	14.4	108
BL-NL-1003	14.4	108
BL-NL-1004	14.4	108
BL-NL-1005	14.4	108
BL-NL-1006	14,4	108
BL-NL-1001	220-240 V	108
BL-NL-1002	220-240 V	108
BL-NL-1003	220-240 V	108
BL-NL-1004	220-240 V	108
BL-NL-1005	220-240 V	108
BL-NL-1006	220-240 V	108
BL-NL-1007	220-240 V	108
BL-NL-1008	220-240 V	108
134-2001		108
134-2001		108
134-2001		108
ŞERİT LED TRAFOLARI LED STRIP TRANSFORMERS		
BL-T1-132-1599	60W	110
BL-T1-132-1600	120W	110
BL-T1-132-1601	150W	110
BL-T1-132-1602	200W	110
BL-T1-132-1603	250W	110
BL-T1-132-1604	360W	110

Ürün Kodu Product Code	Sayfa No Page No
SİGORTA KUTULARI FUSE BOXES	
BR-818	112
BR-819	112
BR-820	112
BR-821	112
BR-804	113
BR-803	113
BR-806	113
BR-805	113
BR-808	113
BR-807	113
BR-816	114
BR-815	114
BR-814	114
BR-813	114
BR-810	115
BR-809	115
BR-812	115
BR-811	115
BR-850	116
BR-851	116
BR-860	116
TERMOPLASTİK BUATLAR THERMOPLASTIC CONJECTIONS	
BR-750	118
BR-760	118
BR-770	118
BUAT VE DÜBELLER JUNCTION BOXES AND DOWELS	
BR-1713	118
BR-710	118
BR-901	118
BR-902	118
LÜKS KARE BUATLAR LUXURIOUS SQUARE CONJECTIONS	
BR-730	119
BR-731	119
BR-732	119
BR-734	119
BR-733	119
GEÇMELİ ve ALÇIPAN KASA INTERLACED AND DRYWALL CASE	
BR-1413	119
BR-1708	119
BR-1712	119
BR-1413-E	119
BR-1708-E	119
BR-1712-E	119

Ürün Kodu Product Code	Sayfa No Page No
GRUP PRİZ GROUP SOCKET	
BR-1552-0	120
BR-1552-2	120
BR-1552-3	120
BR-1552-5	120
BR-1553-0	120
BR-1553-2	120
BR-1553-3	120
BR-1553-5	120
BR-1554-0	120
BR-1554-2	120
BR-1554-3	120
BR-1554-5	120
BR-1556-0	120
BR-1556-2	120
BR-1556-3	120
BR-1556-5	120
BR-1572-0	122
BR-1572-2	122
BR-1572-3	122
BR-1572-5	122
BR-1573-0	122
BR-1573-2	122
BR-1573-3	122
BR-1573-5	122
BR-1574-0	122
BR-1574-2	122
BR-1574-3	122
BR-1574-5	122
BR-1576-0	122
BR-1576-2	122
BR-1576-3	122
BR-1576-5	122
BR-1562-0	122
BR-1562-2	122
BR-1562-3	122
BR-1562-5	122
BR-1563-0	122
BR-1563-2	122
BR-1563-3	122
BR-1563-5	122
BR-1564-0	122
BR-1564-2	122
BR-1564-3	122
BR-1564-5	122
BR-1566-0	122
BR-1566-2	122
BR-1566-3	122
BR-1566-5	122
BR-1592-0	123

Ürün Kodu Product Code	Sayfa No Page No
BR-1592-2	123
BR-1592-3	123
BR-1592-5	123
BR-1593-0	123
BR-1593-2	123
BR-1593-3	123
BR-1593-5	123
BR-1594-0	123
BR-1594-2	123
BR-1594-3	123
BR-1594-5	123
BR-1596-0	123
BR-1596-2	123
BR-1596-3	123
BR-1596-5	123
BR-1542-0	124
BR-1542-2	124
BR-1542-3	124
BR-1542-5	124
BR-1543-0	124
BR-1543-2	124
BR-1543-3	124
BR-1543-5	124
BR-1584-0	124
BR-1584-2	124
BR-1584-3	124
BR-1584-5	124
BR-1586-0	124
BR-1586-2	124
BR-1586-3	124
BR-1586-5	124
BR-1514	125
AKSESUARLAR ACCESSORIES	
BR-1510	125
BR-1511	125
BR-1515	125
BR-1516	125
BR-001411	125
BR-GU-0001	125
132-1535	125
ÇERÇEVELER FRAMES	
BR-1519	126
BR-1522	126
BR-1521	126
BR-1520	126
134-0922	127
134-0995	127
134-0983	127
134-0963	127
134-0984	127
134-1005	127

Ürün Kodu Product Code	Sayfa No Page No
SIKMALI KABLO PABUCU CABLE LUGS STANDARD SERIES	
BR-1780 M5	128
BR-1780-M5K	128
BR-1781 M5	128
BR-1781-M5K	128
BR-1782 M6	128
BR-1782-M6K	128
BR-1782-M8	128
BR-1782-M8K	128
BR-1783 M8	128
BR-1783-M8K	128
BR-1784 M8	128
BR-1784-M8K	128
BR-1794 M10	128
BR-1794 M10K	128
BR-1785 M10	128
BR-1785-M10K	128
BR-1785 M12	128
BR-1785 M12K	128
BR-1786 M10	128
BR-1786 M12	128
BR-1787 M8	128
BR-1787 M10	128
BR-1787 M12	128
BR-1787 M14	128
BR-1788 M10	128
BR-1788 M12	128
BR-1788 M14	128
BR-1789 M10	128
BR-1789 M12	128
BR-1789 M16	128
BR-1790 M12	128
BR-1790 M16	128
BR-1791 M16	128
BR-1792 M16	128
BR-1792 M20	128
BR-1793 M20	128

HAKKIMIZDA

Borled Aydınlatma, 1984 yılından bugüne yurt içi ve uluslararası aydınlatma sektöründe sürdürülebilir büyüme vizyonu ile yatırımlarına devam eden Borsan Elektrik ve Aydınlatma Ürünleri Grubu, bünyesinde faaliyet göstermektedir. 2017 yılı itibari ile LED'li aydınlatma ürün imalatında faaliyete geçen Borled Aydınlatma, modern teknolojisi ve Borsan tecrübesi sayesinde sektörde liderliğe yükselmeyi hedeflemektedir.

Samsun Organize Sanayi Bölgesi içerisinde bulunan, 15.000m²'lik kapalı alanda üretim ve ürün tasarımları yapan Borled Aydınlatma Fabrikası, plastik üretim hatlarında 880 bin, saç metal üretim hatlarında 750 bin, montaj ve paketleme hatlarında ise 334 bin adet aylık kapasiteye sahiptir. Üretim kimliği, yüksek teknolojiye sahip üretim ekipmanları, laboratuvarı ve kalite yönetimini destekleyen test alanları ve başta İstanbul Perpa'da bulunan yurtiçi/yurtdışı satış ve pazarlama departmanları, paydaşlarının ihtiyaç duyacağı tüm gereksinimleri karşılamaktadır.

Borled Aydınlatma, dünyada süregelen teknolojik gelişmeler ışığında ürün gruplarında dayanıklılığı, verimliliği ve tasarrufu en üst düzeye çıkarmaktadır. Benimsediği toplam kalite yönetimi anlayışı sayesinde, müşteri memnuniyetini her zaman ön planda tutmaktadır. TSE, CE, RoHS gibi ulusal kalite belgeleri ve uluslararası deklarasyonlarına sahip ürünleri ile konut, okul, hastane, ofis, AVM, endüstriyel tesisler ve kamu kuruluşları gibi alanlarda hizmet vermektedir. Bünyesinde bulunan test laboratuvarları, makine parkuru ve uzman kadrosu ile daha fazla alana hizmet vermek için çalışmalarını sürdürmektedir.

Borsan faaliyet gösterdiği tüm sektörlerde bir dünya markası vizyonuna ulaşabilmek için Ar-Ge faaliyetlerine sürekli yatırım yapmaktadır. Sanayi ve Teknoloji Bakanlığı tarafından 2018 yılında tescil edilen Borsan Ar-Ge Merkezi 350m² alanda kurulu Karadeniz'in en büyük Aydınlatma Laboratuvarının yanı sıra, Yangın test Laboratuvarı, Metal ve Polimer Laboratuvarı gibi bölümlerde özel ekipman, cihazlar ve test programlarının kullanılmakta, yirminin üzerinde Ar-Ge mühendisi ve araştırmacı personel görev yapmaktadır.

Borled Aydınlatma Laboratuvarı, her koşulda üstün niteliklere sahip aydınlatma ekipmanlarının tasarımına olanak sağlamaktadır. Uzman ekibi ve modern teknolojisi sayesinde, ışığın hem matematiksel hem de insan fizyolojisini olumlu etkileyecek özelliklerini belirleyerek, tasarımları ve kalitesini her zaman en üst seviyede sunmaktadır. Borled Aydınlatma Laboratuvarı, iç ve dış mekân aydınlatması ile ilgili TS EN 60598-1 (Aydınlatma Armatürleri Güvenlik Gereksinimleri) standardına uygun olarak ölçümler gerçekleştirmektedir. Ürünlerin güvenlik testleri, armatür ve lambaların fotometrik değerleri, elektriksel, kimyasal ve fiziksel özelliklerinin ölçümleri yapılmakta olup, cihazlarda yapılan periyodik ara kontrol ve kalibrasyonlar sayesinde ürün kalitesi en üst seviyede tutulmaktadır.

Borled Aydınlatma, daha yüksek rekabet gücü, yeni pazarlar, ulusal ve uluslararası pazardan daha yüksek pay almak hedefiyle, yeni ürün faaliyetlerine aralıksız devam edecek. Borsan bünyesinde, kalitesiyle fark yaratan, geleceğe gururla taşınan Türkiye'nin lider markalardan biri olmaya daima devam edecektir.

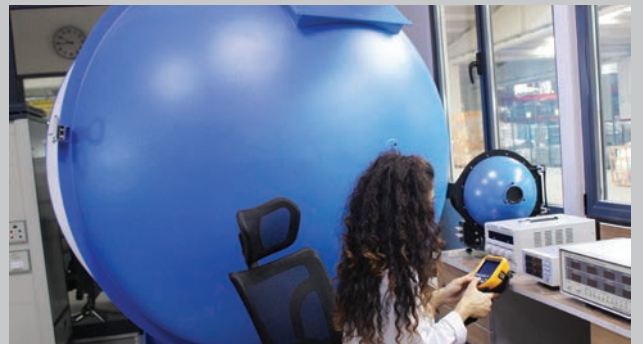

ABOUT US

Borled Lighting, which has 15.000 m² closed area for production and product design located in Samsun Organize Sanayi Bölgesi, continues sales-marketing activities with sales office in Perpa, Istanbul. With its experienced and field-trained R&D, production, sales and marketing teams, it meets all the requirements that our partners need.

In the light of the technological developments in the world, we as Borled Lighting, increase the durability, productivity and savings of our product groups to the highest level. We give top priority to our partners contentment with the understanding of total quality management that we have adopted as a company.

We are proud to serve with our TSE, CE, RoHS certified quality products in feilds of residential, school, hospital, office, shopping mall, industrial facilities, public institutions etc.

Borled Lighting Laboratory is providing us to design high quality products under any circumstances. With our expert team and modern technology, we keep our product designs and quality at top level by determining both the mathematical and positive affect of light on human physiology.

We are proud to serve with our TSE, CE, Rohs certified quality products in feilds of residential, school, hospital, office, shopping mall, industrial facilities, public institutions etc.

Our Borled Lighting Laboratory allow us to make measurements in accordance with TS EN 60598-1 (Lighting Luminaires Safety Requirements) standard for indoor and outdoor lighting. Our products safety tests, photometric values of armatures and lamps, electrical, chemical and physical properties are being tested regularly. With periodic controls and calibrations of our devices we keep our products quality and reliability at the top.

Borsan continuously and consistently invests in R&D activities in all the industries it is active in order to achieve a world brand vision. Registered by the Ministry of Industry and Technology in 2018, Borsan R&D Center is the 3rd registered R&D center in Samsun and 1055th in Turkey.

Borsan R&D Center is built on an area of 350m² and it not only features the largest Illumination Laboratory in all the Black Sea region, but Fire Test Laboratory, Metal and Polymer Laboratory as well. In those labs and departments, where special equipment, devices, gears and testing programs are employed, over 20 R&D engineers and research specialist personnel are working day and night.

Borsan will always be a proud brand growing and leading the way in Turkey with its long-term approach, quality of the highest order aimed at making a difference and strategic investments.



SLIM LED ARMATÜR

SLIM LED ARMATURE

Teknik Özellikler

Technical Specifications

Gövde : Alüminyum
Body : Aluminium

Gövde Renkleri : Beyaz
Body Colors : White

Difüzör : PMMA
Diffuser : PMMA

Renksel Geri Verim : 80
Color Rendering Index : 80

IP Derecesi : IP20
IP Rating : IP20

IK Derecesi : IK03
IK Rating : IK03

Elektriksel Koruma : Sınıf II
Electrical Protection : Class II

Çalışma Sıcaklığı : -20°C / 45°C
Operating Temp. Range : -20°C / 45°C



LED

3
YIL
GARANTİ

50.000
SAAT

SLİM LED ARMATÜR

Kurulumu kolay, maksimum performansa sahip uzun ömürlü, ekonomik ve güvenilir bir siva altı tavan armatürüdür. Tüm iç mekanlarda; evlerde, ofislerde, hastane, otel, avm, mağazalar için idealdir.

SLIM LED ARMATURE

It is an easy to install, long-lasting, economical and reliable flush-mounted ceiling luminaire with maximum performance. In all interiors; Ideal for homes, offices, hospitals, hotels, shopping malls, stores.



YUVARLAK SLİM LED ARMATÜR ROUND SLIM LED ARMATURE

Ürün Kodu Product Code	Güç (W) Power	Renk Sıcaklığı (K) Color Temperature	Işık Akısı (Lm) Luminous Flux	Boyutlar (WxLxH) mm Dimensions	Kesme Ebatı(mm) Cutting Size	Koli Adeti Quantity in Carton	Fiyat Price
BL-S1-2001	3W	3000 K	165	82 × 14	73	48	\$3,55
BL-S1-2002	3W	4000 K	165	82 × 14	73	48	\$3,55
BL-S1-2003	3W	6500 K	165	82 × 14	73	48	\$3,55
BL-S1-2004	6W	3000 K	390	118 × 14	110	48	\$4,80
BL-S1-2005	6W	4000 K	390	118 × 14	110	48	\$4,80
BL-S1-2006	6W	6500 K	390	118 × 14	110	48	\$4,80
BL-S1-2007	9W	3000 K	630	145 × 14	135	24	\$6,30
BL-S1-2008	9W	4000 K	630	145 × 14	135	24	\$6,30
BL-S1-2009	9W	6500 K	630	145 × 14	135	24	\$6,30
BL-S1-2010	12W	3000 K	960	168 × 14	155	24	\$7,25
BL-S1-2011	12W	4000 K	960	168 × 14	155	24	\$7,25
BL-S1-2012	12W	6500 K	960	168 × 14	155	24	\$7,25
BL-S1-2013	15W	3000 K	1200	190 × 14	175	24	\$7,75
BL-S1-2014	15W	4000 K	1200	190 × 14	175	24	\$7,75
BL-S1-2015	15W	6500 K	1200	190 × 14	175	24	\$7,75
BL-S1-2016	18W	3000 K	1440	225 × 15	210	24	\$8,80
BL-S1-2017	18W	4000 K	1440	225 × 15	210	24	\$8,80
BL-S1-2018	18W	6500 K	1440	225 × 15	210	24	\$8,80
BL-S1-2019	24W	3000 K	2040	300 × 15	285	24	\$15,35
BL-S1-2020	24W	4000 K	2040	300 × 15	285	24	\$15,35
BL-S1-2021	24W	6500 K	2040	300 × 15	285	24	\$15,35

KARE SLİM LED ARMATÜR SQUARE SLIM LED ARMATURE

Ürün Kodu Product Code	Güç (W) Power	Renk Sıcaklığı (K) Color Temperature	Işık Akısı (Lm) Luminous Flux	Boyutlar (WxLxH) mm Dimensions	Kesme Ebatı(mm) Cutting Size	Koli Adeti Quantity in Carton	Fiyat Price
BL-S1-2022	18W	3000 K	1350	225 × 225 × 15	210 × 210	24	\$10,60
BL-S1-2023	18W	4000 K	1350	225 × 225 × 15	210 × 210	24	\$10,60
BL-S1-2024	18W	6500 K	1350	225 × 225 × 15	210 × 210	24	\$10,60
BL-S1-2025	24W	3000 K	1920	300 × 300 × 15	280 × 280	24	\$17,35
BL-S1-2026	24W	4000 K	1920	300 × 300 × 15	280 × 280	24	\$17,35
BL-S1-2027	24W	6500 K	1920	300 × 300 × 15	280 × 280	24	\$17,35



Teknik veri / Datasheet

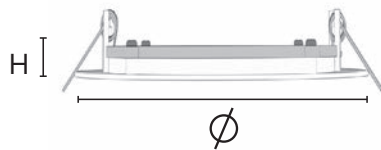

SIVA ÜSTÜ LED PANEL ARMATÜR

SURFACE MOUNTED LED PANEL

Teknik Özellikler

Technical Specifications

Gövde : Alüminyum
Body : Aluminium

Gövde Renkleri : Beyaz
Body Colors : White

Çerçeve : DKP Sac
Frame : DKP Metal Sheet

Difüzör : PMMA
Diffuser : PMMA

Renksel Geri Verim : 80
Color Rendering Index : 80

IP Derecesi : IP20
IP Rating : IP20

IK Derecesi : IK03
IK Rating : IK03

Elektriksel Koruma : Sınıf II
Electrical Protection : Class II

Çalışma Sıcaklığı : -20°C / 45°C
Operating Temp. Range : -20°C / 45°C



LED

3
YIL
GARANTİ

50.000
SAAT

SIVA ÜSTÜ LED PANEL ARMATÜR

Önemli ölçüde enerji ve bakım tasarrufu sağlayan yüksek performanslı düz panel armatürdür.

Şık minimalist tasarıma sahip ince led panellerimiz, azaltılmış enerji tüketimi ile geleneksel floresan tipi aydınlatma çözümlerine eşdeğerdir. Uygun maliyetli, ince bir aydınlatma hattı gerektiren ofis, sağlık, eğitim, otel, restoran, alışveriş merkezi ve ticari alanlar gibi geniş bir uygulama yelpazesi için uygundur.

SURFACE MOUNTED LED PANEL

It is a high-performance flat panel luminaire that provides significant energy and maintenance savings.

Our slim led panels with stylish minimalist design are equivalent to traditional fluorescent type lighting solutions with reduced energy consumption. It is suitable for a wide range of applications such as office, health, education, hotel, restaurant, shopping mall and commercial areas that require a cost-effective, thin line of lighting.



SIVA ÜSTÜ YUVARLAK LED PANEL

SURFACE MOUNTED ROUND LED PANEL

Ürün Kodu Product Code	Güç (W) Power	Renk Sıcaklığı (K) Color Temperature	Işık Akısı (Lm) Luminous Flux	Boyutlar (ØxH) mm Dimensions	Koli Adeti Quantity in Carton	Fiyat Price
BL-S2-2013	15W	3000 K	1200	162 × 25	20	\$6,50
BL-S2-2014	15W	4000 K	1200	162 × 25	20	\$6,50
BL-S2-2015	15W	6500 K	1200	162 × 25	20	\$6,50
BL-S2-2016	18W	3000 K	1440	210 × 25	20	\$7,75
BL-S2-2017	18W	4000 K	1440	210 × 25	20	\$7,75
BL-S2-2018	18W	6500 K	1440	210 × 25	20	\$7,75
BL-S2-2019	24W	3000 K	2040	285 × 25	20	\$11,75
BL-S2-2020	24W	4000 K	2040	285 × 25	20	\$11,75
BL-S2-2021	24W	6500 K	2040	285 × 25	20	\$11,75

SIVA ÜSTÜ KARE LED PANEL

SURFACE MOUNTED SQUARE LED PANEL

Ürün Kodu Product Code	Güç (W) Power	Renk Sıcaklığı (K) Color Temperature	Işık Akısı (Lm) Luminous Flux	Boyutlar (WxLxH) mm Dimensions	Koli Adeti Quantity in Carton	Fiyat Price
BL-S2-2022	15W	3000 K	1200	162 × 162 × 25	20	\$7,10
BL-S2-2023	15W	4000 K	1200	162 × 162 × 25	20	\$7,10
BL-S2-2024	15W	6500 K	1200	162 × 162 × 25	20	\$7,10
BL-S2-2025	18W	3000 K	1440	210 × 210 × 25	20	\$8,60
BL-S2-2026	18W	4000 K	1440	210 × 210 × 25	20	\$8,60
BL-S2-2027	18W	6500 K	1440	210 × 210 × 25	20	\$8,60
BL-S2-2028	24W	3000 K	2040	285 × 285 × 25	20	\$12,85
BL-S2-2029	24W	4000 K	2040	285 × 285 × 25	20	\$12,85
BL-S2-2030	24W	6500 K	2040	285 × 285 × 25	20	\$12,85



Teknik veri / Datasheet

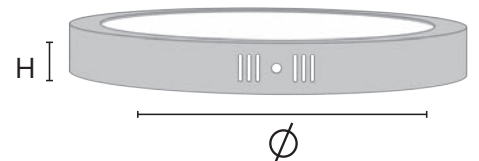
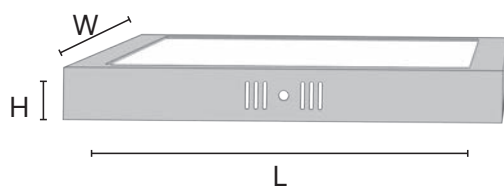

BACKLIGHT DOWNLIGHT ARMATÜR

BACKLIGHT DOWNLIGHT ARMATURE

Teknik Özellikler

Technical Specifications

Gövde : Alüminyum
Body : Aluminium

Gövde Renkleri : Beyaz
Body Colors : White

Difüzör : PMMA
Diffuser : PMMA

Renksel Geri Verim : 80
Color Rendering Index : 80

IP Derecesi : IP40
IP Rating : IP40

IK Derecesi : IK03
IK Rating : IK03

Elektriksel Koruma : Sınıf II
Electrical Protection : Class II

Çalışma Sıcaklığı : -20°C / 45°C
Operating Temp. Range : -20°C / 45°C



LED

3
YIL
GARANTİ

50.000
SAAT

IP40

BACKLIGHT DOWNLIGHT ARMATÜR

Özel alüminyum alaşımlı kasası mükemmel ısı dağılımı sağlar. Yeni nesil devre tasarımı akım sürücüsü ile yüksek ışık gücüne, verimli enerji tasarrufu ve maksimum performansa sahip bir siva altı tavan armatürüdür. Kolay kurulum, uzun ömürlü, ekonomik ve güvenilir bir kullanım sunar.

Tüm iç mekanlarda; evlerde, ofislerde, hastane, otel, avm, mağaza ve özellikle vitrinler için idealdir.

BACKLIGHT DOWNLIGHT ARMATURE

Its special Aluminium alloy casing provides excellent heat dissipation. It is a flush-mounted ceiling luminaire with high light power, efficient energy saving and maximum performance with its new generation circuit design current driver. It offers easy installation, long-lasting, economical and reliable use.

In all interiors; It is ideal for homes, offices, hospitals, hotels, shopping malls, stores and especially showcases.



YUVARLAK BACKLIGHT DOWNLIGHT ARMATÜR ROUND BACKLIGHT DOWNLIGHT ARMATURE

Ürün Kodu Product Code	Güç (W) Power	Renk Sıcaklığı (K) Color Temperature	Işık Akısı (Lm) Luminous Flux	Boyutlar (ØxH) mm Dimensions	Kesme Ebatı(mm) Cutting Size	Koli Adeti Quantity in Carton	Fiyat Price
BL-BD-0001	10W	3000 K	1110	94 × 42	73	50	\$24,00
BL-BD-0002	10W	4000 K	1110	94 × 42	73	50	\$24,00
BL-BD-0003	10W	6500 K	1110	94 × 42	73	50	\$24,00
BL-BD-0004	15W	3000 K	1575	127 × 46	97	50	\$29,55
BL-BD-0005	15W	4000 K	1575	127 × 46	97	50	\$29,55
BL-BD-0006	15W	6500 K	1575	127 × 46	97	50	\$29,55
BL-BD-0007	20W	3000 K	2220	164 × 58	140	50	\$33,70
BL-BD-0008	20W	4000 K	2220	164 × 58	140	50	\$33,70
BL-BD-0009	20W	6500 K	2220	164 × 58	140	50	\$33,70
BL-BD-0010	30W	3000 K	3330	222 × 54,5	177	50	\$53,35
BL-BD-0011	30W	4000 K	3330	222 × 54,5	177	50	\$53,35
BL-BD-0012	30W	6500 K	3330	222 × 54,5	177	50	\$53,35

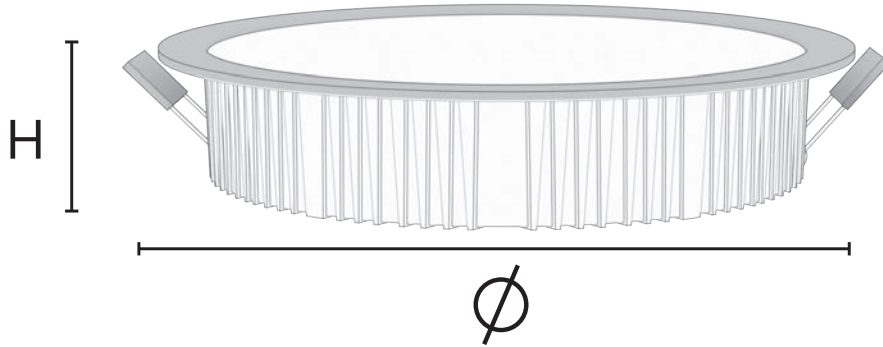

Teknik veri / Datasheet

BETA BACKLIGHT DOWNLIGHT

BETA BACKLIGHT DOWNLIGHT

Teknik Özellikler Technical Specifications

Gövde : Alüminyum
Body : Aluminium

Gövde Renkleri : Beyaz
Body Colors : White

Difüzör : PMMA
Diffuser : PMMA

Renksel Geri Verim : 80
Color Rendering Index : 80

IP Derecesi : IP40
IP Rating : IP40

IK Derecesi : IK03
IK Rating : IK03

Elektriksel Koruma : Sınıf II
Electrical Protection : Class II

Çalışma Sıcaklığı : -20°C / 45°C
Operating Temp. Range : -20°C / 45°C



LED

3
YIL
GARANTİ

50.000
SAAT



BETA BACKLIGHT DOWNLIGHT

Özel alüminyum alaşımlı kasası mükemmel ısı dağılımı sağlar. Yeni nesil devre tasarımı akım sürücüsü ile yüksek ışık gücüne, verimli enerji tasarrufu ve maksimum performansa sahip bir sıva altı tavan armatürüdür. Kolay kurulum, uzun ömürlü, ekonomik ve güvenilir bir kullanım sunar.

Tüm iç mekanlarda; evlerde, ofislerde, hastane, otel, avm, mağaza ve özellikle vitrinler için idealdir.

BETA BACKLIGHT DOWNLIGHT

Its special Aluminium alloy casing provides excellent heat dissipation. It is a flush-mounted ceiling luminaire with high light power, efficient energy saving and maximum performance with its new generation circuit design current driver. It offers easy installation, long-lasting, economical and reliable use.

In all interiors; It is ideal for homes, offices, hospitals, hotels, shopping malls, stores and especially showcases.



BETA BACKLIGHT DOWNLIGHT ARMATÜR

BETA BACKLIGHT DOWNLIGHT ARMATURE

Ürün Kodu Product Code	Güç (W) Power	Renk Sıcaklığı (K) Color Temperature	Işık Akısı (Lm) Luminous Flux	Boyutlar (ØxH) mm Dimensions	Kesme Ebatı(mm) Cutting Size	Koli Adeti Quantity in Carton	Fiyat Price
BL-BD-2001	8W	3000 K	800	97 × 55	85	36	Fiyat Sorunuz
BL-BD-2002	8W	4000 K	800	97 × 55	85	36	Fiyat Sorunuz
BL-BD-2003	8W	6500 K	800	97 × 55	85	36	Fiyat Sorunuz
BL-BD-2004	10W	3000 K	1000	117 × 48	105	36	Fiyat Sorunuz
BL-BD-2005	10W	4000 K	1000	117 × 48	105	36	Fiyat Sorunuz
BL-BD-2006	10W	6500 K	1000	117 × 48	105	36	Fiyat Sorunuz
BL-BD-2007	15W	3000 K	1500	147 × 54	130	36	Fiyat Sorunuz
BL-BD-2008	15W	4000 K	1500	147 × 54	130	36	Fiyat Sorunuz
BL-BD-2009	15W	6500 K	1500	147 × 54	130	36	Fiyat Sorunuz
BL-BD-2010	18W	3000 K	1800	175 × 58	160	18	Fiyat Sorunuz
BL-BD-2011	18W	4000 K	1800	175 × 58	160	18	Fiyat Sorunuz
BL-BD-2012	18W	6500 K	1800	175 × 58	160	18	Fiyat Sorunuz
BL-BD-2013	25W	3000 K	2500	192 × 55	175	16	Fiyat Sorunuz
BL-BD-2014	25W	4000 K	2500	192 × 55	175	16	Fiyat Sorunuz
BL-BD-2015	25W	6500 K	2500	192 × 55	175	16	Fiyat Sorunuz
BL-BD-2016	30W	3000 K	3000	227 × 58	210	16	Fiyat Sorunuz
BL-BD-2017	30W	4000 K	3000	227 × 58	210	16	Fiyat Sorunuz
BL-BD-2018	30W	6500 K	3000	227 × 58	210	16	Fiyat Sorunuz



Teknik veri / Datasheet

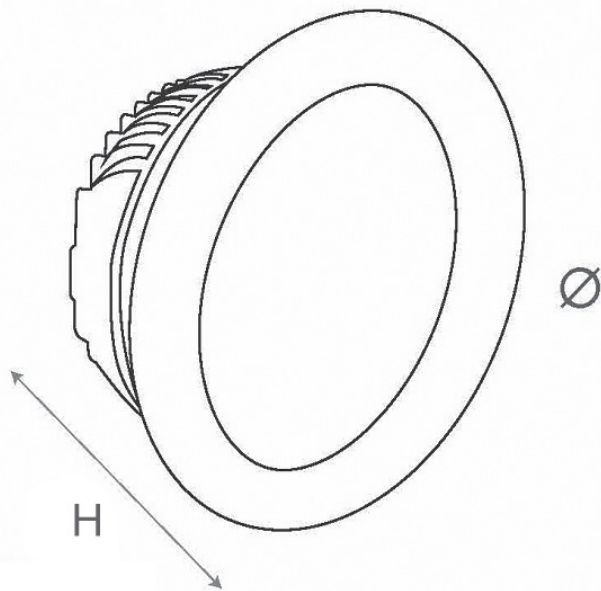

COB LED ARMATÜR

COB LED ARMATURE

Teknik Özellikler

Technical Specifications

Gövde : Alüminyum
Body : Aluminium

IP Derecesi : IP20
IP Rating : IP20

Güç Faktörü : 0.9
Power Factor : 0.9

Renksel Geri Verim : 80
Color Rendering Index : 80



LED

3
YIL
GARANTİ

50.000
SAAT



COB LED ARMATÜR

Yüksek kalitede Led çipine sahiptir. Renk değişimlerine ve sararmaya dayanıklı, alüminyum enjeksiyonlu, elektrostatik toz boyalı ve uzun ömürlü homojen ışık veren optik ekranlı bir aydınlatma armatürüdür.

Ayrıca 0-20° ayarlanabilir ışık yönü, bağlantı klipsleri ile lamba panelini ve elleri korur, montajı kolaydır.

Ürünümüzü ev, ofis, mağaza, müze, kafe vb. birçok yerde gönül rahatlığı ile tercih edebilirsiniz.

COB LED ARMATURE

It has a high-quality Led chip. It is a luminaire with an optical screen that is resistant to colour changes and yellowing, is an aluminium injection, electrostatic powder-coated and gives long-lasting homogeneous light.

In addition, 0-20° adjustable light direction, connection clips protect the lamp panel and hands. It's easy to install.

You can use our product in your home, office, shop, museum, cafe, etc. You can choose from many places with peace of mind.



COB LED ARMATÜR

COB LED ARMATURE

Ürün Kodu Product Code	Güç (W) Power	Renk Sıcaklığı (K) Color Temperature	Işık Akısı (Lm) Luminous Flux	Boyutlar (ØxH) mm Dimensions	Boyutlar (ØxH) mm Dimensions	Koli Adeti Quantity in Carton	Fiyat Price
BL-COB1-0001	7W	3000 K	700	108 × 65	85	36	Fiyat Sorunuz
BL-COB1-0002	7W	4000 K	700	108 × 65	85	36	Fiyat Sorunuz
BL-COB1-0003	7W	6500 K	700	108 × 65	85	36	Fiyat Sorunuz
BL-COB1-0004	9W	3000 K	900	128 × 55	105	36	Fiyat Sorunuz
BL-COB1-0005	9W	4000 K	900	128 × 55	105	36	Fiyat Sorunuz
BL-COB1-0006	9W	6500 K	900	128 × 55	105	36	Fiyat Sorunuz
BL-COB1-0007	12W	3000 K	1250	150 × 55	130	36	Fiyat Sorunuz
BL-COB1-0008	12W	4000 K	1250	150 × 55	130	36	Fiyat Sorunuz
BL-COB1-0009	12W	6500 K	1250	150 × 55	130	36	Fiyat Sorunuz
BL-COB1-0010	25W	3000 K	2500	200 × 55	180	16	Fiyat Sorunuz
BL-COB1-0011	25W	4000 K	2500	200 × 55	180	16	Fiyat Sorunuz
BL-COB1-0012	25W	6500 K	2500	200 × 55	180	16	Fiyat Sorunuz
BL-COB1-0013	30W	3000 K	3000	240 × 58	210	16	Fiyat Sorunuz
BL-COB1-0014	30W	4000 K	3000	240 × 58	210	16	Fiyat Sorunuz
BL-COB1-0015	30W	6500 K	3000	240 × 58	210	16	Fiyat Sorunuz



Teknik veri / Datasheet

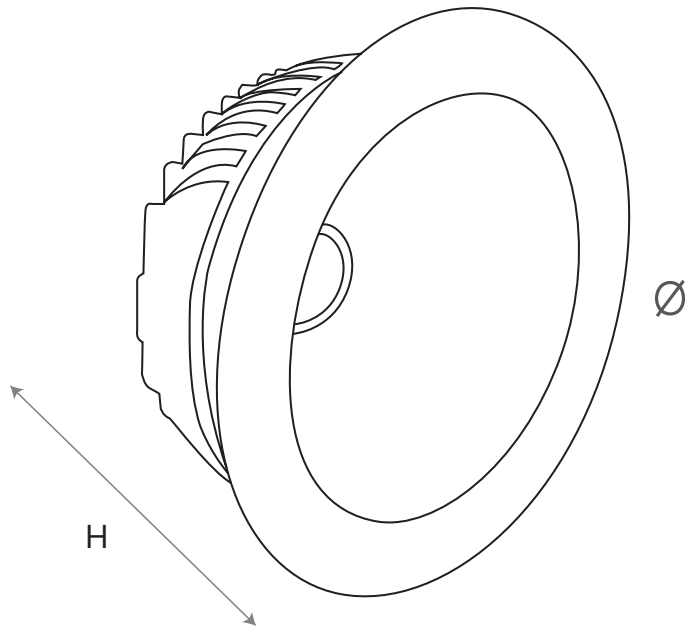

GU10 DUYLU SPOT

GU10 SPOT

Teknik Özellikler

Technical Specifications

Gövde : Alüminyum
Body : Aluminium

IP Derecesi : IP20
IP Rating : IP20

Montaj : Sıva Altı
Mounting : Flush Mounted

Kullanım : GU10 Led/Halojen Ampul
Usage : GU10 Led/Halogen Bulb



GU10 DUYLU SPOT (İKİLİ KASA)

GU10 SPOT (DOUBLE CASE)



GU10 DUYLU SPOT

Sıva altı kullanıma uygun, sağlam ve estetik alüminyum alaşım gövde. GU 10 duy tipi ampuller ile Enkandesan ampullerin yerine düşük enerji tüketimi, yüksek ışık çıkışı ve aydınlatma konforu sağlar.

Ürünümüzü ev, ofis, mağaza, müze, kafe vb. birçok yerde gönül rahatlığı ile tercih edebilirsiniz.

GU10 SPOT

Solid and aesthetic aluminium alloy body suitable for flush-mounted use. GU 10 socket type bulbs provide low energy consumption, high light output and lighting comfort instead of incandescent bulbs.

You can use our product in your home, office, shop, museum, cafe, etc. You can choose from many places with peace of mind.



GU10 DUYLU SPOT

GU10 SPOT

Ürün Kodu Product Code	Giriş Voltajı Input Voltage	Duy Tipi Socket Type	Renk Color	Boyutlar (mm) Dimensions	İç Çap (mm) Inner Diameter	Koli Adeti Quantity in Carton	Fiyat Price
BL-GU-1001	220-230 V AC	GU-10	Siyah	100 × 30	85	100	\$7,85
BL-GU-1002	220-230 V AC	GU-10	Beyaz	100 × 30	85	100	\$7,85
BL-GU-1003	220-230 V AC	GU-10	Siyah	100 × 100 × 30	85	100	\$8,70
BL-GU-1004	220-230 V AC	GU-10	Beyaz	100 × 100 × 30	85	100	\$8,70

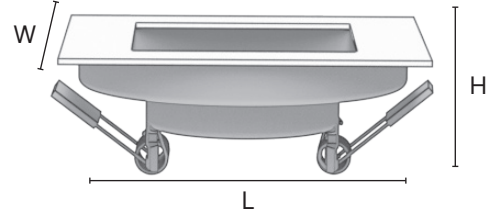
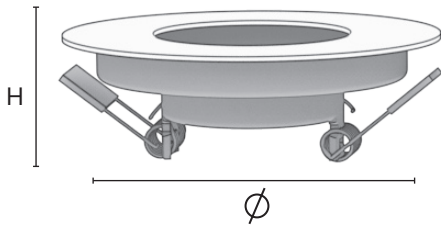

GU10 DUYLU SPOT (İKİLİ KASA)

GU10 SPOT (DOUBLE CASE)

Ürün Kodu Product Code	Giriş Voltajı Input Voltage	Duy Tipi Socket Type	Renk Color	Boyutlar (WxL) Dimensions	İç Ölçüler Inner Dimensions	Koli Adeti Quantity in Carton	Fiyat Price
BL-GU-2001	220-230 V AC	GU-10	Siyah	100 × 185	85 × 165	40	\$16,60
BL-GU-2002	220-230 V AC	GU-10	Beyaz	100 × 185	85 × 165	40	\$16,60
BL-GU-2003	220-230 V AC	GU-10	Siyah	100 × 185	85 × 165	40	\$16,60
BL-GU-2004	220-230 V AC	GU-10	Beyaz	100 × 185	85 × 165	40	\$16,60

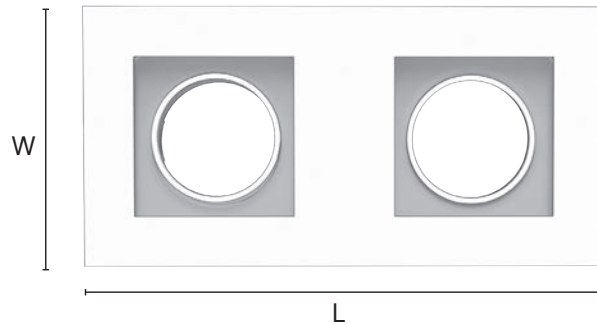

Teknik veri / Datasheet

SIVA ÜSTÜ GU10 DUYLU ARMATÜR

SURFACE FITTING GU10 ARMATURE

Teknik Özellikler

Technical Specifications

Gövde : Alüminyum
Body : Aluminium

IP Derecesi : IP20
IP Rating : IP20

Montaj : Sıva Üstü
Mounting : Surface Mounted

Kullanım : GU10 Led Ampul
Usage : GU10 Led Bulb



SIVA ÜSTÜ GU10 DUYLU ARMATÜR

Sıva üstü kullanıma uygun, sağlam ve estetik alüminyum alaşım gövde. GU 10 duy tipi ampuller ile Enkandesan ampullerin yerine düşük enerji tüketimi, yüksek ışık çıkışı ve aydınlatma konforu sağlar.

Ürünümüzü ev, ofis, mağaza, müze, kafe vb. birçok yerde gönül rahatlığı ile tercih edebilirsiniz.

SURFACE FITTING GU10 ARMATURE

Durable and aesthetic aluminium alloy body suitable for surface-mounted use. GU 10 socket type bulbs provide low energy consumption, high light output and lighting comfort instead of incandescent bulbs.

You can use our product in your home, office, shop, museum, cafe, etc. You can choose from many places with peace of mind.



KARE SIVA ÜSTÜ GU10 DUYLU ARMATÜR

SQUARE SURFACE FITTING GU10 ARMATURE

Ürün Kodu Product Code	Duy Tipi Socket Type	Boyutlar (WxL) mm Dimensions	Renk Color	Koli Adeti Quantity in Carton	Fiyat Price
BL-GU-1005	GU-10	80×80	Siyah	40	\$17,25
BL-GU-1006	GU-10	80×80	Beyaz	40	\$17,25

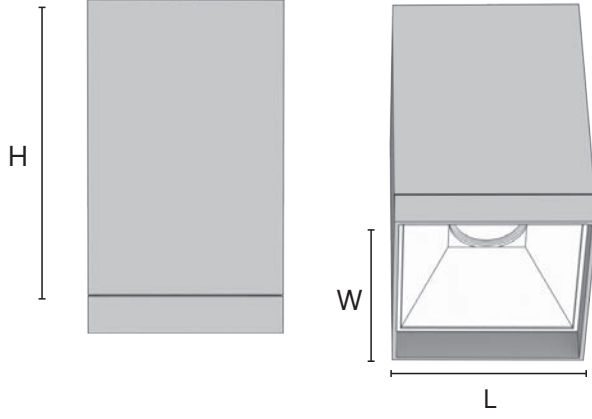

YUVARLAK SIVA ÜSTÜ GU10 DUYLU ARMATÜR

ROUND SURFACE FITTING GU10 ARMATURE

Ürün Kodu Product Code	Duy Tipi Socket Type	Dış Çap mm Outer Diameter	Renk Color	Koli Adeti Quantity in Carton	Fiyat Price
BL-GU-1007	GU-10	80	Siyah	40	\$13,85
BL-GU-1008	GU-10	80	Beyaz	40	\$13,85

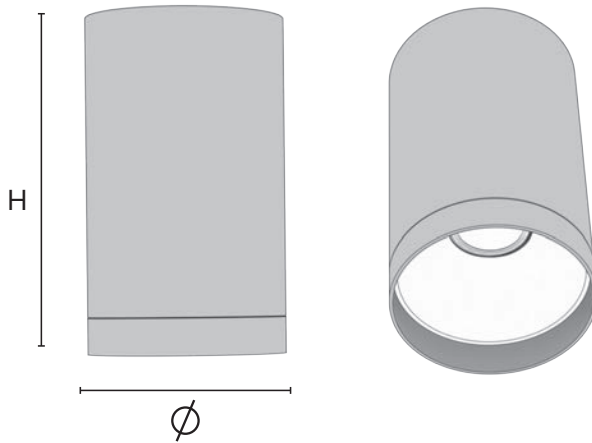

Teknik veri / Datasheet

RAY SPOT GU10 DUYLU ARMATÜR

RAIL SPOT GU10 WITH SOCKET ARMATURE

Teknik Özellikler

Technical Specifications

Gövde : Alüminyum
Body : Aluminium

IP Derecesi : IP20
IP Rating : IP20

Montaj : Ray
Mounting : Rail

Kullanım : GU10 Led Ampul
Usage : GU10 Led Bulb



GU10 DUYLU RAY SPOT

GU10 Duylu Ray Spotlar; başta mağaza, müze, sahne, kafe, restoran, ofis vb. birçok yerde kullanılan aydınlatma armatürleridir. Tavana veya duvara monte edilmiş ray aparatı üzerinde hareket edebilir ve kendi ekseninde 360° yön değiştirerek vitrin, raf, stand ve reyon gibi belirli bölgeleri aydınlatarak dikkat çekerler.

GU 10 duy tipi ampuller ile Enkandesan ampullerin yerine düşük enerji tüketimi, yüksek ışık çıkışı ve aydınlatma konforu sağlar.

RAIL SPOT GU10 WITH SOCKET ARMATURE

GU10 With Socket Rail Spots; mainly for the shop, museum, stage, cafe, restaurant, office etc. They are lighting fixtures used in many places. They can move on the ceiling or wall-mounted rail apparatus and change direction 360° on their axis, attracting attention by illuminating certain areas such as showcases, shelves, stands and sections.

GU 10 socket type bulbs provide low energy consumption, high light output and lighting comfort instead of incandescent bulbs.



RAY SPOT GU10 DUYLU ARMATÜR

RAIL SPOT GU10 WITH SOCKET ARMATURE

Ürün Kodu Product Code	Giriş Voltajı Input Voltage	Duy Tipi Socket Type	Renk Color	İç Çap(mm) Inner Diameter	Koli Adeti Quantity in Carton	Fiyat Price
BL-GU-1010	220-230 V AC	GU-10	Siyah	55	40	Fiyat Sorunuz
BL-GU-1011	220-230 V AC	GU-10	Beyaz	55	40	Fiyat Sorunuz

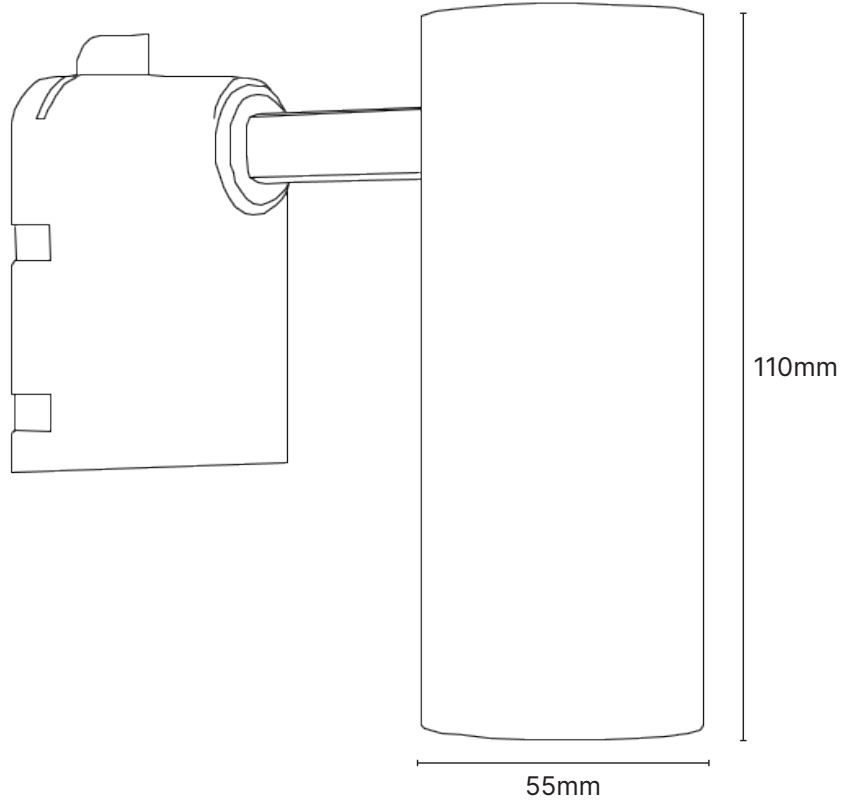

Teknik veri / Datasheet

LED FRAMELESS DOWNLIGHT ARMATÜR

LED FRAMELESS DOWNLIGHT ARMATURE

Teknik Özellikler

Technical Specifications

Gövde : Alüminyum
Body : Aluminium

Gövde Renkleri : Beyaz
Body Colors : White

Difüzör : Polikarbonat (PC)
Diffuser : Polycarbonate

Renksel Geri Verim : 80
Color Rendering Index : 80

IP Derecesi : IP40
IP Rating : IP40

IK Derecesi : IK04
IK Rating : IK04

Elektriksel Koruma : Sınıf II
Electrical Protection : Class II

Çalışma Sıcaklığı : -20°C / 45°C
Operating Temp. Range : -20°C / 45°C



LED

3
YIL
GARANTİ

50.000
SAAT

LED FRAMELESS DOWNLIGHT ARMATÜR

2'si 1 arada çerçevesiz ince şık ve kullanışlı tasarım, alüminyum soğutucu taban, daha esnek ve kullanımı rahat klipsler ile hem yüzeye hem de gömme olarak monte edebilirsiniz.

LED FRAMELESS DOWNLIGHT ARMATURE

With 2 in 1 frameless slim, stylish and useful design, aluminium cooler base, more flexible and convenient to use clips, you can be mounted both on the surface and flush.



LED FRAMELESS DOWNLIGHT ARMATÜR

LED FRAMELESS DOWNLIGHT ARMATURE

Ürün Kodu Product Code	Güç (W) Power	Renk Sıcaklığı (K) Color Temperature	Işık Akısı (Lm) Luminous Flux	Boyutlar (ØxH) mm Dimensions	Kesme Ebatı (mm) Cutting Size	Koli Adeti Quantity in Carton	Fiyat Price
BL-D1-0001	9W	3000 K	900	Ø90 × 20	55 - 80	36	\$8,30
BL-D1-0002	9W	4000 K	900	Ø90 × 20	55 - 80	36	\$8,30
BL-D1-0003	9W	6500 K	900	Ø90 × 20	55 - 80	36	\$8,30
BL-D1-0004	18W	3000 K	1800	Ø120 × 20	55 - 105	24	\$11,25
BL-D1-0005	18W	4000 K	1800	Ø120 × 20	55 - 105	24	\$11,25
BL-D1-0006	18W	6500 K	1800	Ø120 × 20	55 - 105	24	\$11,25
BL-D1-0007	24W	3000 K	2400	Ø175 × 20	55 - 160	16	\$15,70
BL-D1-0008	24W	4000 K	2400	Ø175 × 20	55 - 160	16	\$15,70
BL-D1-0009	24W	6500 K	2400	Ø175 × 20	55 - 160	16	\$15,70
BL-D1-0010	36W	3000 K	3600	Ø225 × 20	55 - 210	12	\$22,70
BL-D1-0011	36W	4000 K	3600	Ø225 × 20	55 - 210	12	\$22,70
BL-D1-0012	36W	6500 K	3600	Ø225 × 20	55 - 210	12	\$22,70

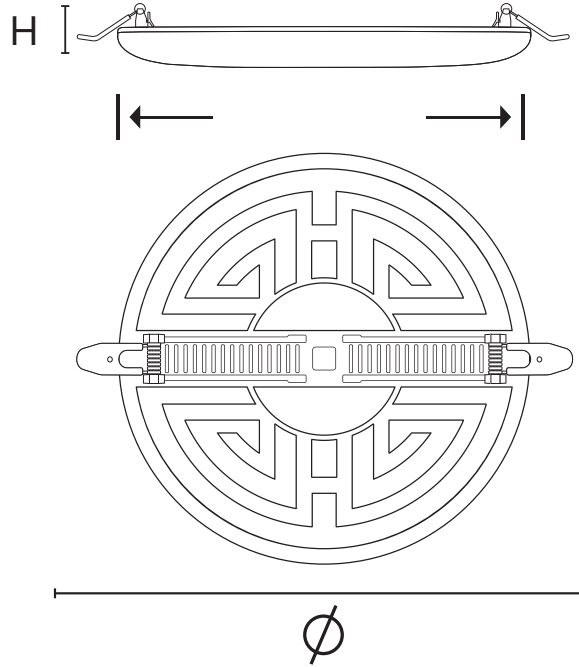

Teknik veri / Datasheet

SLIM LED PANEL ARMATÜR

SLIM LED PANEL ARMATURE

Teknik Özellikler

Technical Specifications

Gövde : Alüminyum
Body : Aluminium

Gövde Renkleri : Beyaz
Body Colors : White

Difüzör : PMMA
Diffuser : PMMA

Renksel Geri Verim : 80
Color Rendering Index : 80

IK Derecesi : IK03
IK Rating : IK03

Elektriksel Koruma : Sınıf II
Electrical Protection : Class II

Çalışma Sıcaklığı : -20°C / 45°C
Operating Tem. Range : -20°C / 45°C



LED

3
YIL
GARANTİ

50.000
SAAT

SLIM LED PANEL ARMATÜR

Önemli ölçüde enerji ve bakım tasarrufu sağlayan yüksek performanslı düz panel armatürdür.

Şık minimalist tasarıma sahip ince led panellerimiz, azaltılmış enerji tüketimi ile geleneksel floresan tipi aydınlatma çözümlerine eşdeğerdir. Uygun maliyetli, ince bir aydınlatma hattı gerektiren ofis, sağlık, eğitim, otel, restoran, alışveriş merkezi ve ticari alanlar gibi geniş bir uygulama yelpazesi için uygundur.

SLIM LED PANEL ARMATURE

It is a high-performance flat panel luminaire that provides significant energy and maintenance savings.

Our slim led panels with stylish minimalist design are equivalent to traditional fluorescent type lighting solutions with reduced energy consumption. It is suitable for a wide range of applications such as office, health, education, hotel, restaurant, shopping mall and commercial areas that require a cost-effective, thin line of lighting.



60X60 SLIM LED PANEL ARMATÜR

60X60 SLIM LED PANEL ARMATURE

Ürün Kodu Product Code	Güç (W) Power	Renk Sıcaklığı (K) Color Temperature	Işık Akısı (Lm) Luminous Flux	Boyutlar (WxLxH) mm Dimensions	Kesme Ebatı(mm) Cutting Size	Koli Adeti Quantity in Carton	Fiyat Price
BL-O5-2001	40W	3000 K	3600	595 × 595 × 7,5	580 × 580	12	\$43,40
BL-O5-2002	40W	4000 K	3600	595 × 595 × 7,5	580 × 580	12	\$43,40
BL-O5-2003	40W	6500 K	3600	595 × 595 × 7,5	580 × 580	12	\$43,40

30X30 SLIM LED PANEL ARMATÜR

30X30 SLIM LED PANEL ARMATURE

Ürün Kodu Product Code	Güç (W) Power	Renk Sıcaklığı (K) Color Temperature	Işık Akısı (Lm) Luminous Flux	Boyutlar (WxLxH) mm Dimensions	Kesme Ebatı(mm) Cutting Size	Koli Adeti Quantity in Carton	Fiyat Price
BL-O8-0001	24W	3000 K	1600	295 × 295 × 7,5	270 × 270	12	\$26,60
BL-O8-0002	24W	4000 K	1600	295 × 295 × 7,5	270 × 270	12	\$26,60
BL-O8-0003	24W	6500 K	1600	295 × 295 × 7,5	270 × 270	12	\$26,60

30X60 SLIM LED PANEL ARMATÜR

30X60 SLIM LED PANEL ARMATURE

Ürün Kodu Product Code	Güç (W) Power	Renk Sıcaklığı (K) Color Temperature	Işık Akısı (Lm) Luminous Flux	Boyutlar (WxLxH) mm Dimensions	Kesme Ebatı(mm) Cutting Size	Koli Adeti Quantity in Carton	Fiyat Price
BL-O6-2001	24W	3000 K	1600	295 × 595 × 7,5	270 × 580	12	\$33,00
BL-O6-2002	24W	4000 K	1600	295 × 595 × 7,5	270 × 580	12	\$33,00
BL-O6-2003	24W	6500 K	1600	295 × 595 × 7,5	270 × 580	12	\$33,00

30X120 SLIM LED PANEL ARMATÜR

30X120 SLIM LED PANEL ARMATURE

Ürün Kodu Product Code	Güç (W) Power	Renk Sıcaklığı (K) Color Temperature	Işık Akısı (Lm) Luminous Flux	Boyutlar (WxLxH) mm Dimensions	Kesme Ebatı(mm) Cutting Size	Koli Adeti Quantity in Carton	Fiyat Price
BL-O7-2001	48W	3000 K	3200	295 × 1195 x 7,5	270 × 1180	12	\$61,70
BL-O7-2002	48W	4000 K	3200	295 × 1195 x 7,5	270 × 1180	12	\$61,70
BL-O7-2003	48W	6500 K	3200	295 × 1195 x 7,5	270 × 1180	12	\$61,70



Teknik veri / Datasheet

LED OPAL LENSİ SLİM BACKLIGHT ARMATÜR

LED SLİM BACKLIGHT ARMATURE - OPAL LENS

Teknik Özellikler

Technical Specifications

Gövde : DKP Sac
Body : DKP Metal Sheet

Gövde Renkleri : Beyaz
Body Colors : White

Difüzör : PMMA
Diffuser : PMMA

Renksel Geri Verim : 80
Color Rendering Index : 80

IP Derecesi : IP20
IP Rating : IP20

IK Derecesi : IK02
IK Rating : IK02

Elektriksel Koruma : Sınıf II
Electrical Protection : Class II

Çalışma Sıcaklığı : -20°C / 45°C
Operating Temp.Range : -20°C / 45°C

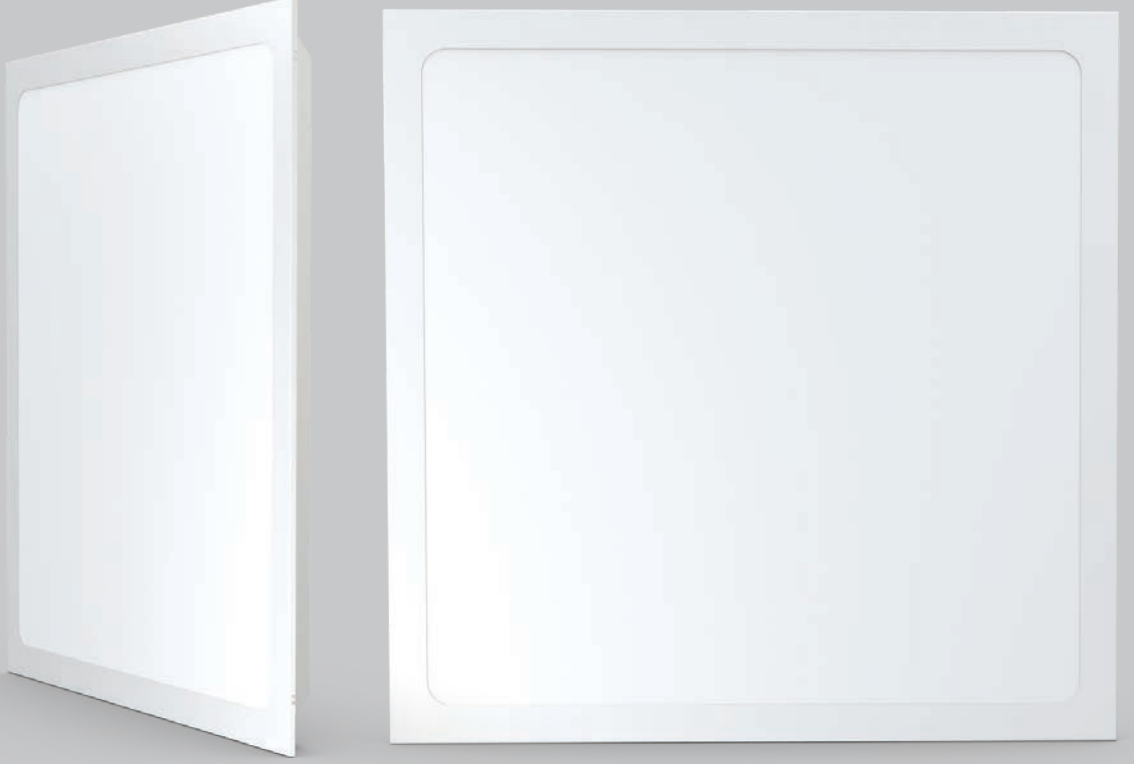

LED

3
YIL
GARANTİ

50.000
SAAT

LED OPAL LENSİ SLİM BACKLIGHT ARMATÜR

Alçıpan tavan çeşitleri ile uyumlu gövde yapısı, tüm iç mekanların genel aydınlatma ihtiyacını karşılamak için idealdir. Optimum ışık geçirgenliğine ve homojen yayılmaya sahip, sararma ve renk değiştirmeyen opal lens difüzörü ile fark yaratır.

LED SLİM BACKLIGHT ARMATURE - OPAL LENS

The body structure compatible with plasterboard ceiling types is ideal for meeting the general lighting needs of all interior spaces. It makes a difference with its opal lens diffuser, which has an optimum light transmission and homogeneous spread, which does not turn yellow or change colour.



LED OPAL LENSİLİ SLİM BACKLIGHT ARMATÜR LED SLİM BACKLIGHT ARMATURE - OPAL LENS

Ürün Kodu Product Code	Güç (W) Power	Renk Sıcaklığı (K) Color Temperature	Işık Akısı (Lm) Luminous Flux	Boyutlar (WxLxH) mm Dimensions	Koli Adeti Quantity in Carton	Fiyat Price
BL-O2-3008	15W	3000 K	1350	295 × 295 × 35	12	\$18,20
BL-O2-3009	15W	4000 K	1350	296 × 295 × 35	12	\$18,20
BL-O2-3010	15W	6500 K	1350	297 × 295 × 35	12	\$18,20
BL-O2-2011	40W	3000 K	3600	595 × 595 × 35	6	\$27,60
BL-O2-2012	40W	4000 K	3600	595 × 595 × 35	6	\$27,60
BL-O2-2013	40W	6500 K	3600	595 × 595 × 35	6	\$27,60

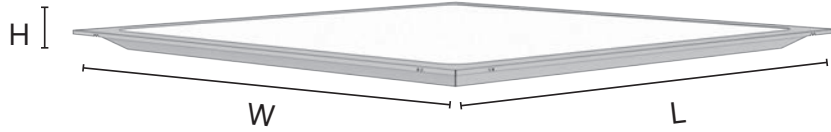

Teknik veri / Datasheet

LED OPAL LENS Lİ SLİM BACKLIGHT ARMATÜR TSE

LED SLİM BACKLIGHT ARMATURE - OPAL LENS TSE

Teknik Özellikler Technical Specifications

Gövde : DKP Sac
Body : DKP Metal Sheet

Gövde Renkleri : Beyaz
Body Colors : White

Difüzör : PMMA
Diffuser : PMMA

Renksel Geri Verim : 80
Color Rendering Index : 80

IP Derecesi : IP20
IP Rating : IP20

İK Derecesi : IK02
IK Rating : IK02

Elektriksel Koruma : Sınıf II
Electrical Protection : Class II

Çalışma Sıcaklığı : -20°C / 45°C
Operating Temp.Range : -20°C / 45°C



LED

3
YIL
GARANTİ

50.000
SAAT

LED OPAL LENS Lİ SLİM BACKLIGHT ARMATÜR

Alçıpan tavan çeşitleri ile uyumlu gövde yapısı, tüm iç mekanların genel aydınlatma ihtiyacını karşılamak için idealdir. Optimum ışık geçirgenliğine ve homojen yayılmaya sahip, sararma ve renk değiştirmeyen opal lens difüzörü ile fark yaratır.

LED SLİM BACKLIGHT ARMATURE - OPAL LENS

The body structure compatible with plasterboard ceiling types is ideal for meeting the general lighting needs of all interior spaces. It makes a difference with its opal lens diffuser, which has an optimum light transmission and homogeneous spread, which does not turn yellow or change colour.



LED OPAL LENSİ SLIM BACKLIGHT ARMATÜR TSE

LED SLIM BACKLIGHT ARMATURE - OPAL LENS TSE

Ürün Kodu Product Code	Güç (W) Power	Renk Sıcaklığı (K) Color Temperature	Işık Akısı (Lm) Luminous Flux	Boyutlar (WxLxH) mm Dimensions	Koli Adeti Quantity in Carton	Fiyat Price
BLT-O2-3008	15W	3000 K	1350	295 × 295 × 35	12	Fiyat Sorunuz
BLT-O2-3009	15W	4000 K	1350	296 × 295 × 35	12	Fiyat Sorunuz
BLT-O2-3010	15W	6500 K	1350	297 × 295 × 35	12	Fiyat Sorunuz
BLT-O2-2011	40W	3000 K	3600	595 × 595 × 35	6	Fiyat Sorunuz
BLT-O2-2012	40W	4000 K	3600	595 × 595 × 35	6	Fiyat Sorunuz
BLT-O2-2013	40W	6500 K	3600	595 × 595 × 35	6	Fiyat Sorunuz

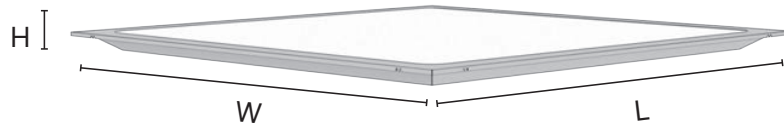

Teknik veri / Datasheet



LED OPAL LENS Lİ BACKLIGHT ARMATÜR

LED BACKLIGHT ARMATURE - OPAL LENS

Teknik Özellikler

Technical Specifications

Gövde : DKP Sac
Body : DKP Metal Sheet

Gövde Renkleri : Beyaz
Body Colors : White

Difüzör : Akriik (PMMA)
Diffuser : Acrylic (PMMA)

Sürücü : Eaglerise/Osram/Tridonic
Driver : Eaglerise/Osram/Tridonic

Renksel Geri Verim : 80
Color Rendering Index : 80

IP Derecesi : IP20
IP Rating : IP20

IK Derecesi : IK03
IK Rating : IK03

Elektriksel Koruma : Sınıf I
Electrical Protection : Class I

Çalışma Sıcaklığı : -20°C / 45°C
Operating Temp. Range : -20°C / 45°C



LED

3
YIL
GARANTİ

50.000
SAAT

LED OPAL LENS Lİ BACKLIGHT ARMATÜR

Alçıpan tavan çeşitleri ile uyumlu gövde yapısı ve harici siva üstü çerçeveler sayesinde tüm iç mekanların genel aydınlatma ihtiyacını karşılamak için idealdir. Optimum ışık geçirgenliğine ve homojen yayılmaya sahip, sararma ve renk değiştirmeyen opal lens difüzörü ile fark yaratır.

LED BACKLIGHT ARMATURE - OPAL LENS

It is ideal for meeting the general lighting needs of all interior spaces thanks to its body structure compatible with plasterboard ceiling types and external surface-mounted frames. It makes a difference with its opal lens diffuser, which has optimum light transmittance and homogeneous spread that does not turn yellow and does not change colour.



LED OPAL LENSİLİ BACKLIGHT SIVA ALTI ARMATÜR

LED FLUSH MOUNTED BACKLIGHT ARMATURE - OPAL LENS

Ürün Kodu Product Code	Güç (W) Power	Renk Sıcaklığı (K) Color Temperature	Işık Akısı (Lm) Luminous Flux	Boyutlar (WxLxH) mm Dimensions	Koli Adeti Quantity in Carton	Fiyat Price
BLT-O2-2005	12W	4000 K	1575	300 × 300 × 65	8	\$46,00
BLT-O2-2006	12W	6500 K	1575	300 × 300 × 65	8	\$46,00
BLT-O6-0002	24W	4000 K	2750	300 × 600 × 65	4	\$77,95
BLT-O6-0003	24W	6500 K	2750	300 × 600 × 65	4	\$77,95
BLT-O2-2002	36W	4000 K	4500	600 × 600 × 65	2	\$73,50
BLT-O2-2003	36W	6500 K	4500	600 × 600 × 65	2	\$73,50

LED OPAL LENSİLİ BACKLIGHT SIVA ÜSTÜ ARMATÜR

LED SURFACE MOUNTED BACKLIGHT ARMATURE - OPAL LENS

Ürün Kodu Product Code	Güç (W) Power	Renk Sıcaklığı (K) Color Temperature	Işık Akısı (Lm) Luminous Flux	Boyutlar (WxLxH) mm Dimensions	Koli Adeti Quantity in Carton	Fiyat Price
BLT-O5-2005	12W	4000 K	1575	300 × 300 × 65	8	\$55,20
BLT-O5-2006	12W	6500 K	1575	300 × 300 × 65	8	\$55,20
BLT-O6-1002	24W	4000 K	2750	300 × 600 × 65	4	\$93,25
BLT-O6-1003	24W	6500 K	2750	300 × 600 × 65	4	\$93,25
BLT-O5-2008	36W	4000 K	4500	600 × 600 × 65	2	\$88,85
BLT-O5-2009	36W	6500 K	4500	600 × 600 × 65	2	\$88,85

LED OPAL LENSİLİ BACKLIGHT CLIP-IN ARMATÜR

LED BACKLIGHT CLIP-IN ARMATURE - OPAL LENS

Ürün Kodu Product Code	Güç (W) Power	Renk Sıcaklığı (K) Color Temperature	Işık Akısı (Lm) Luminous Flux	Boyutlar (WxLxH) mm Dimensions	Koli Adeti Quantity in Carton	Fiyat Price
BLT-O2-3011	12W	4000 K	1575	300 × 300 × 65	8	\$53,25
BLT-O2-3012	12W	6500 K	1575	300 × 300 × 65	8	\$53,25
BLT-O6-2002	24W	4000 K	2750	300 × 600 × 65	4	\$93,25
BLT-O6-2003	24W	6500 K	2750	300 × 600 × 65	4	\$93,25
BLT-O2-2008	36W	4000 K	4500	600 × 600 × 65	2	\$74,85
BLT-O2-2009	36W	6500 K	4500	600 × 600 × 65	2	\$74,85



Teknik veri / Datasheet

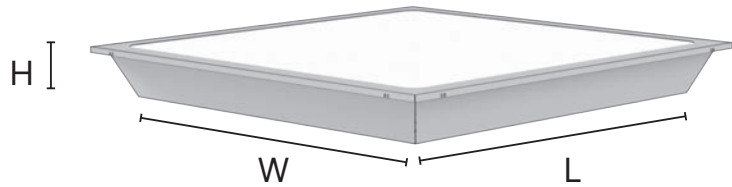

LED BACKLIGHT STERIL ORTAM ARMATÜR

LED BACKLIGHT STERILE AMBIENT ARMATURE

Teknik Özellikler

Technical Specifications

Gövde : DKP Sac
Body : DKP Metal Sheet

Gövde Renkleri : Beyaz
Body Colors : White

Difüzör : Temperli Cam
Diffuser : Tempered Glass

Renksel Geri Verim : 80
Color Rendering Index : 80

IP Derecesi : IP65
IP Rating : IP65

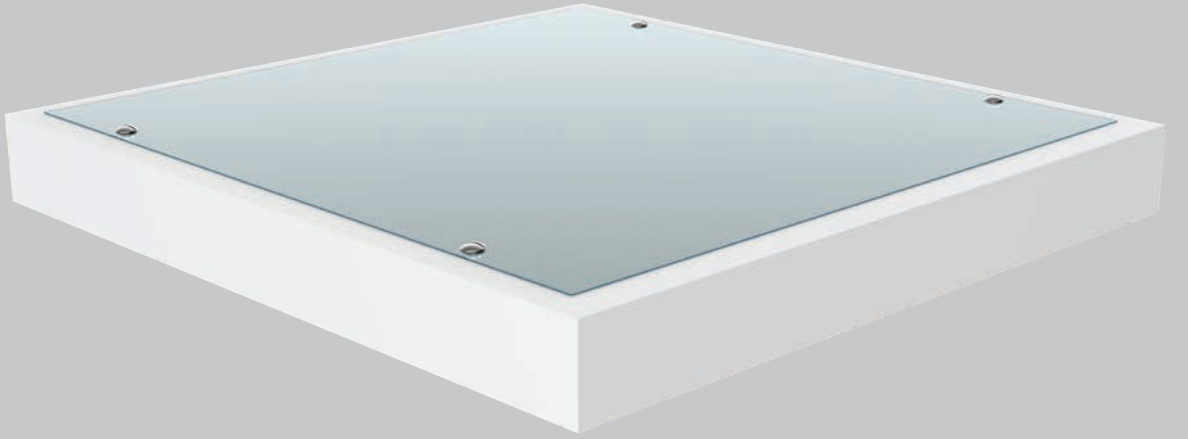
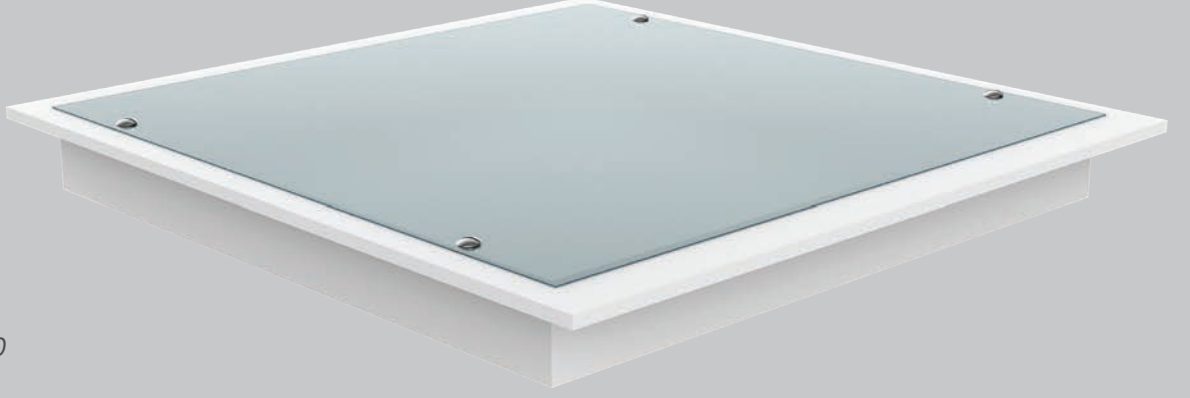

LED

3
YIL
GARANTİ

50.000
SAAT

IP65

LED BACKLIGHT STERIL ORTAM ARMATÜR

Temperli cam çerçevesi ile bireysel ve homojen aydınlatma sağlayan steril ortam armatürüdür. Verimli ve hijyen aydınlatma gerektiren tüm iç mekanlar, hastaneler, laboratuvarlar, klinikler, eczaneler, temiz odalar, gıda hazırlama alanları gibi yerler için idealdir.

LED BACKLIGHT STERILE AMBIENT ARMATURE

It is a sterile environment luminaire that provides individual and homogeneous lighting with its tempered glass frame. All interior spaces require efficient and hygienic lighting. Ideal for hospitals, laboratories, clinics, pharmacies, clean rooms, food preparation areas.



LED BACKLIGHT STERIL ORTAM SIVA ALTI ARMATÜR

LED BACKLIGHT STERILE AMBIENT ARMATURE

Ürün Kodu Product Code	Güç (W) Power	Renk Sıcaklığı (K) Color Temperature	Işık Akısı (Lm) Luminous Flux	Boyutlar (WxLxH) mm Dimensions	Koli Adeti Quantity in Carton	Fiyat Price
BL-O2-3001	15W	4000 K	2160	300 × 300 x 110	1	\$126,10
BL-O2-3002	15W	6500 K	2160	300 × 300 x 110	1	\$126,10
BL-O2-4001	35W	4000 K	4442	600 × 600 x 100	1	\$200,15
BL-O2-4002	35W	6500 K	4442	600 × 600 x 100	1	\$200,15

LED BACKLIGHT STERIL ORTAM SIVA ÜSTÜ ARMATÜR

LED BACKLIGHT STERILE AMBIENT ARMATURE

Ürün Kodu Product Code	Güç (W) Power	Renk Sıcaklığı (K) Color Temperature	Işık Akısı (Lm) Luminous Flux	Boyutlar (WxLxH) mm Dimensions	Koli Adeti Quantity in Carton	Fiyat Price
BL-O5-3001	15W	4000 K	2160	300 × 300 x 110	1	\$135,45
BL-O5-3002	15W	6500 K	2160	300 × 300 x 110	1	\$135,45
BL-O5-4001	35W	4000 K	4442	600 × 600 x 100	1	\$214,40
BL-O5-4002	35W	6500 K	4442	600 × 600 x 100	1	\$214,40

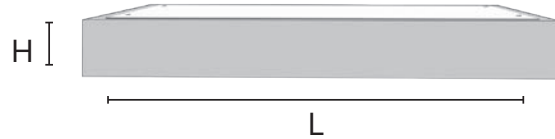
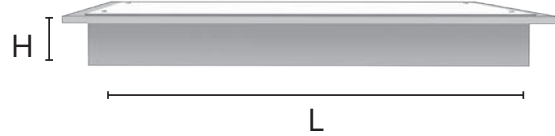
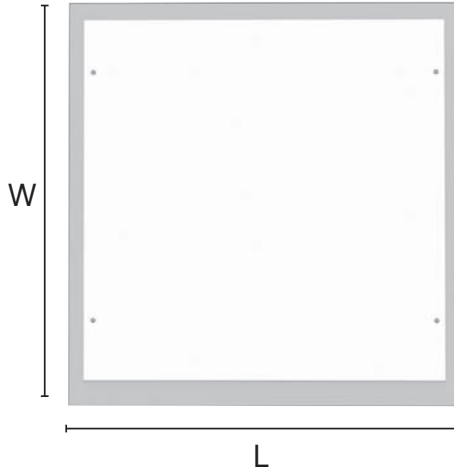

Teknik veri / Datasheet



LED PROJEKTÖR PLATİN SERİSİ

LED PROJECTOR PLATINUM SERIES

Teknik Özellikler

Technical Specifications

Gövde : Alüminyum
Body : Aluminium

Cam : Temperli Cam
Glass : Tempered Glass

Renksel Geri Verim : 70
Color Rendering Index : 70

IP Derecesi : IP65
IP Rating : IP65

IK Derecesi : IK08
IK Rating : IK08

Elektriksel Koruma : Sınıf I
Electrical Protection : Class I



LED

3 YIL GARANTİ

50.000 SAAT

IP65

LED PROJEKTÖR PLATİN SERİSİ

Led Projektörleri uzun mesafeli açık alanlarda, şehir meydanlarında, spor sahalarında, fabrika ve tesislerin aydınlatması vb birçok alanda rahatlıkla tercih edebilirsiniz. Darbelere dayanıklı, su ve toz geçirmez. IP65 standartlarına uygundur. Enerji tasarrufu, güvenilir performans ve uzun ömürlü kullanım sağlar.

LED PROJECTOR PLATINUM SERIES

You can easily choose Led Projectors in long-distance open areas, city squares, sports fields, lighting of factories and facilities, etc. Shockproof, waterproof and dustproof. It complies with IP65 standards. It provides energy-saving, reliable performance and long-lasting use.



LED PROJEKTÖR PLATİN SERİSİ

LED PROJECTOR PLATINUM SERIES

Ürün Kodu Product Code	Güç (W) Power	Renk Sıcaklığı (K) Color Temperature	Işık Akısı (Lm) Luminous Flux	Boyutlar (WxLxH) mm Dimensions	Renk Color	Koli Adeti Quantity in Carton	Fiyat Price
BL-P2-0001	10W	6500 K	800	87 × 115 × 32	Siyah	32	\$10,55
BL-P2-0002	10W	4000 K	800	87 × 115 × 32	Siyah	32	\$10,55
BL-P2-0003	10W	3000 K	800	87 × 115 × 32	Siyah	32	\$10,55
BL-P2-0004	20W	6500 K	1600	107 × 137 × 32	Siyah	32	\$15,45
BL-P2-0005	20W	4000 K	1600	107 × 137 × 32	Siyah	32	\$15,45
BL-P2-0006	20W	3000 K	1600	107 × 137 × 32	Siyah	32	\$15,45
BL-P2-0007	30W	6500 K	2400	140 × 180 × 33	Siyah	16	\$23,15
BL-P2-0008	30W	4000 K	2400	140 × 180 × 33	Siyah	16	\$23,15
BL-P2-0009	30W	3000 K	2400	140 × 180 × 33	Siyah	16	\$23,15
BL-P2-0010	50W	6500 K	4000	185 × 227 × 36	Siyah	10	\$32,90
BL-P2-0011	50W	4000 K	4000	185 × 227 × 36	Siyah	10	\$32,90
BL-P2-0012	50W	3000 K	4000	185 × 227 × 36	Siyah	10	\$32,90
BL-P2-0013	70W	6500 K	5600	240 × 290 × 40	Siyah	5	\$53,40
BL-P2-0014	70W	4000 K	5600	240 × 290 × 40	Siyah	5	\$53,40
BL-P2-0015	70W	3000 K	5600	240 × 290 × 40	Siyah	5	\$53,40
BL-P2-0016	100W	6500 K	8000	240 × 290 × 40	Siyah	5	\$61,95
BL-P2-0017	100W	4000 K	8000	240 × 290 × 40	Siyah	5	\$61,95
BL-P2-0018	100W	3000 K	8000	240 × 290 × 40	Siyah	5	\$61,95
BL-P2-0019	150W	6500 K	12000	290 × 370 × 61	Siyah	3	\$105,30
BL-P2-0020	150W	4000 K	12000	290 × 370 × 61	Siyah	3	\$105,30
BL-P2-0021	150W	3000 K	12000	290 × 370 × 61	Siyah	3	\$105,30
BL-P2-0022	200W	6500 K	16000	310 × 440 × 65	Siyah	3	\$138,55
BL-P2-0023	200W	4000 K	16000	310 × 440 × 65	Siyah	3	\$138,55
BL-P2-0024	200W	3000 K	16000	310 × 440 × 65	Siyah	3	\$138,55



Teknik veri / Datasheet

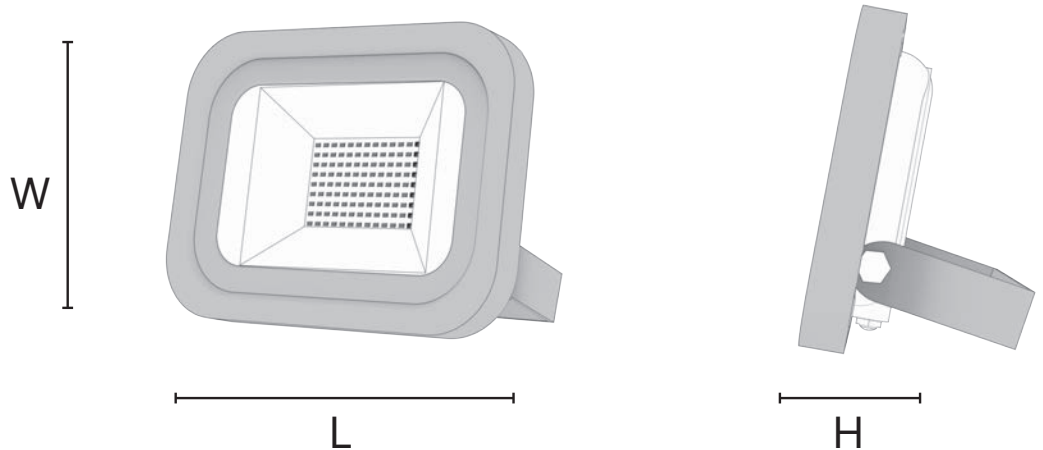

LED PROJKTÖR PLATIN SERİSİ

LED PROJECTOR PLATINUM SERIES

Teknik Özellikler

Technical Specifications

Gövde : Alüminyum
Body : Aluminium

Cam : Temperli Cam
Glass : Tempered Glass

Renksel Geri Verim : 70
Color Rendering Index : 70

IP Derecesi : IP65
IP Rating : IP65

IK Derecesi : IK08
IK Rating : IK08

Elektriksel Koruma : Sınıf I
Electrical Protection : Class I



LED

3 YIL GARANTİ

50.000 SAAT

IP65



SENSÖRLÜ LED PROJKTÖR PLATİN SERİSİ

Ayarlanabilir hareket sensörü ile önemli miktarda enerji tasarrufu, güvenilir performans ve uzun ömürlü kullanım sağlar. IP65 standartlarına uygun olarak darbelere dayanıklı, su ve toz geçirmez.

SENSOR LED PROJECTOR PLATINUM SERIES

With its adjustable motion sensor, it provides significant energy savings, reliable performance and long-lasting use.

Shockproof, waterproof and dustproof in accordance with IP65 standards.

YEŞİL LED PROJKTÖR PLATİN SERİSİ

Peyzaj mimarisinde, çevre ve mekanların estetik aydınlatılmasına uygundur. Enerji tasarrufu, güvenilir performans ve uzun ömürlü kullanım sağlar. IP65 standartlarına uygun olarak darbelere dayanıklı, su ve toz geçirmez.

GREEN LED PROJECTOR PLATINUM SERIES

In landscape architecture, it is suitable for the aesthetic lighting of the environment and spaces. It provides energy-saving, reliable performance and long-lasting use. Shockproof, waterproof and dustproof by IP65 standards.



SENSÖRLÜ LED PROJEKTÖR PLATIN SERISI

SENSOR LED PROJECTOR PLATINUM SERIES

Ürün Kodu Product Code	Güç (W) Power	Renk Sıcaklığı (K) Color Temperature	Işık Akısı (Lm) Luminous Flux	Boyutlar (WxLxH) mm Dimensions	Renk Color	Koli Adeti Quantity in Carton	Fiyat Price
BL-P2-0001-S	10W	6500 K	800	87 × 115 × 32	Siyah	32	\$22,75
BL-P2-0003-S	10W	3000 K	800	87 × 115 × 32	Siyah	32	\$22,75
BL-P2-0004-S	20W	6500 K	1600	107 × 137 × 32	Siyah	32	\$27,95
BL-P2-0006-S	20W	3000 K	1600	107 × 137 × 32	Siyah	32	\$27,95
BL-P2-0007-S	30W	6500 K	2400	140 × 180 × 33	Siyah	16	\$36,60
BL-P2-0009-S	30W	3000 K	2400	140 × 180 × 33	Siyah	16	\$36,60
BL-P2-0010-S	50W	6500 K	4000	185 × 227 × 36	Siyah	10	\$47,60
BL-P2-0012-S	50W	3000 K	4000	185 × 227 × 36	Siyah	10	\$47,60

YEŞİL LED PROJEKTÖR PLATIN SERISI

GREEN LED PROJECTOR PLATINUM SERIES

Ürün Kodu Product Code	Güç (W) Power	Renk Sıcaklığı (K) Color Temperature	Işık Akısı (Lm) Luminous Flux	Boyutlar (WxLxH) mm Dimensions	Renk Color	Koli Adeti Quantity in Carton	Fiyat Price
BL-P2-1GRN	10W	Yeşil Green	800	87 × 115 × 32	Siyah	32	\$10,75
BL-P2-2GRN	20W	Yeşil Green	1600	107 × 137 × 32	Siyah	32	\$16,65
BL-P2-3GRN	30W	Yeşil Green	2400	140 × 180 × 33	Siyah	16	\$24,15
BL-P2-5GRN	50W	Yeşil Green	4000	185 × 227 × 36	Siyah	10	\$33,85

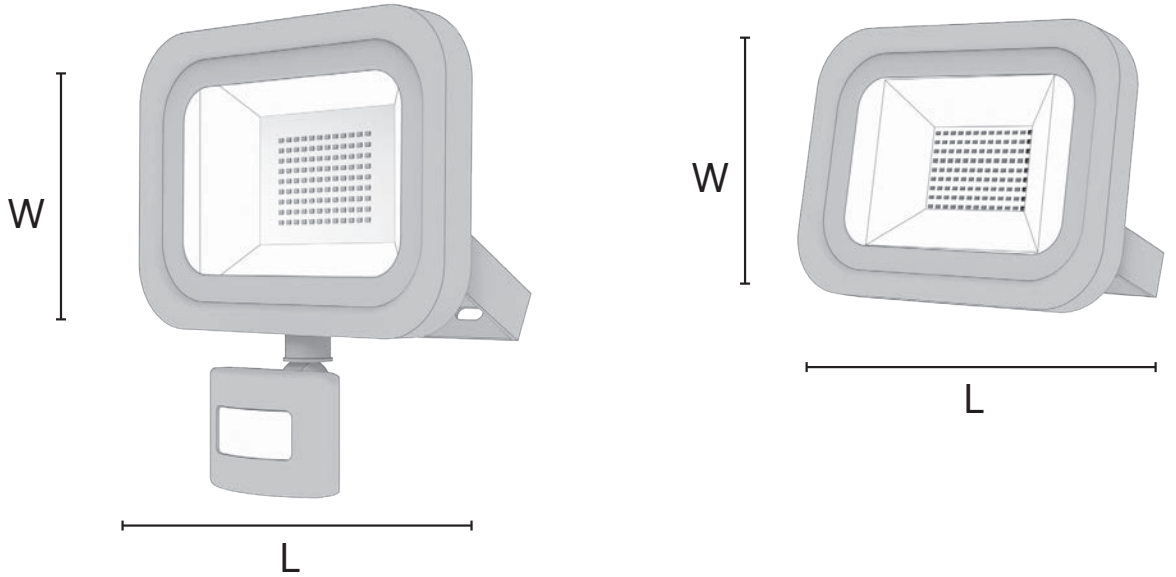

Teknik veri / Datasheet

LED PROJKTÖR GOLD SERİSİ

LED PROJECTOR GOLD SERIES

Teknik Özellikler

Technical Specifications

Gövde : Alüminyum
Body : Aluminium

Cam : Temperli Cam
Glass : Tempered Glass

Renksel Geri Verim : 80
Color Rendering Index : 80

IP Derecesi : IP65
IP Rating : IP65

IK Derecesi : IK08
IK Rating : IK08

Elektriksel Koruma : Sınıf I
Electrical Protection : Class I

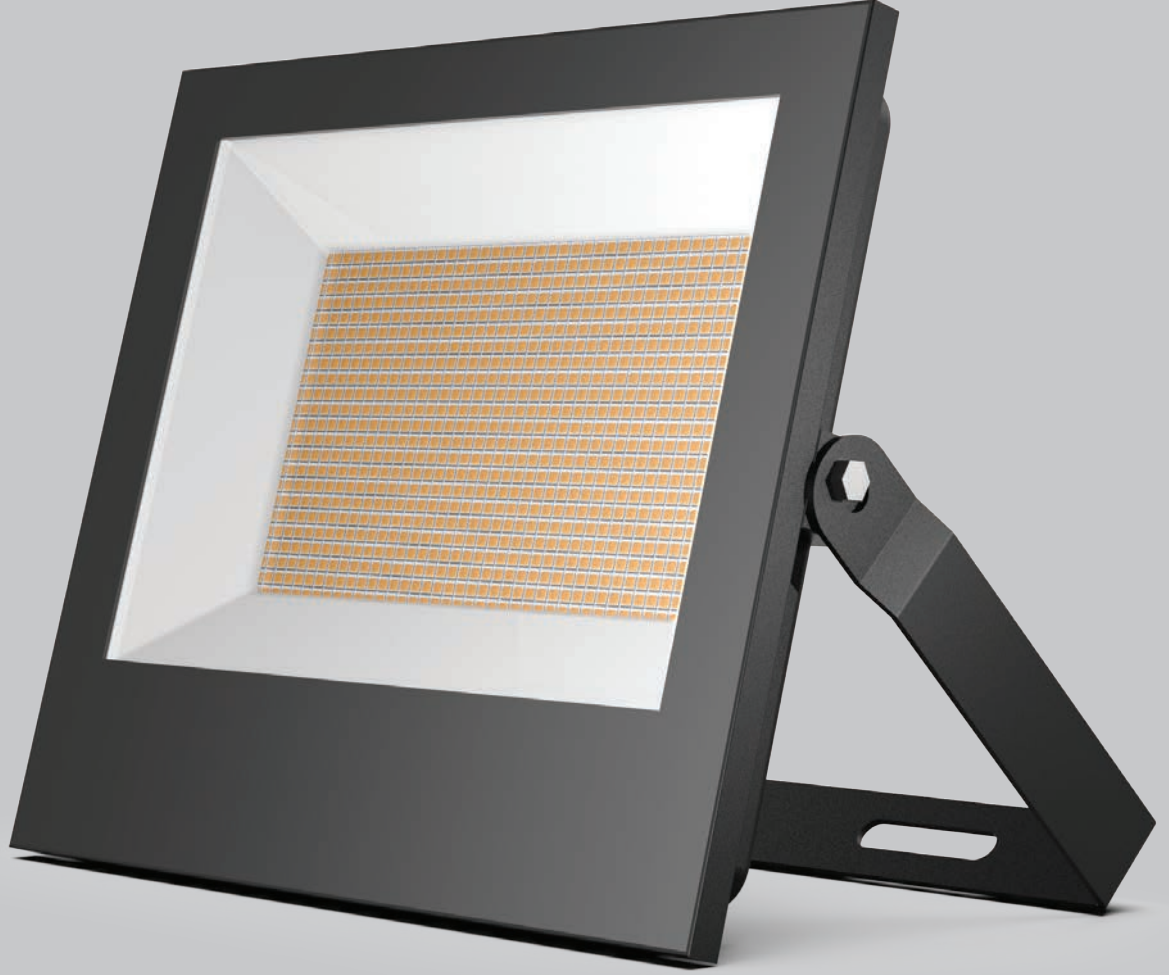

LED

2 YIL
GARANTİ

50.000
SAAT

IP65

LED PROJKTÖR GOLD SERİSİ

Led Projektörleri uzun mesafeli açık alanlarda, şehir meydanlarında, spor sahalarında, fabrika ve tesislerin aydınlatması vb birçok alanda rahatlıkla tercih edebilirsiniz. Darbelere dayanıklı, su ve toz geçirmez. IP65 standartlarına uygundur. Enerji tasarrufu, güvenilir performans ve uzun ömürlü kullanım sağlar.

LED PROJECTOR GOLD SERIES

You can easily choose Led Projectors in long-distance open areas, city squares, sports fields, lighting of factories and facilities, etc. Shockproof, waterproof and dustproof. It complies with IP65 standards. It provides energy-saving, reliable performance and long-lasting use.



LED PROJEKTÖR GOLD SERİSİ

LED PROJECTOR GOLD SERIES

Ürün Kodu Product Code	Güç (W) Power	Renk Sıcaklığı (K) Color Temperature	Işık Akısı (Lm) Luminous Flux	Boyutlar (WxLxH) mm Dimensions	Renk Color	Koli Adeti Quantity in Carton	Fiyat Price
BL-P4-0001	10W	3000 K	800	69 × 98 × 25	Siyah-Black	36	\$8,20
BL-P4-0003	10W	6500 K	800	69 × 98 × 25	Siyah-Black	36	\$8,20
BL-P4-0004	20W	3000 K	1600	92 × 123 × 28	Siyah-Black	36	\$11,55
BL-P4-0006	20W	6500 K	1600	92 × 123 × 28	Siyah-Black	36	\$11,55
BL-P4-0007	30W	3000 K	2400	117 × 157 × 28	Siyah-Black	32	\$16,05
BL-P4-0009	30W	6500 K	2400	117 × 157 × 28	Siyah-Black	32	\$16,05
BL-P4-0010	50W	3000 K	4000	144 × 202 × 28	Siyah-Black	16	\$22,50
BL-P4-0012	50W	6500 K	4000	144 × 202 × 28	Siyah-Black	16	\$22,50
BL-P4-0013	70W	3000 K	5600	186 × 241 × 28	Siyah-Black	10	\$31,95
BL-P4-0015	70W	6500 K	5600	186 × 241 × 28	Siyah-Black	10	\$31,95
BL-P4-0016	100W	3000 K	8000	206 × 266 × 30	Siyah-Black	10	\$45,40
BL-P4-0018	100W	6500 K	8000	206 × 266 × 30	Siyah-Black	10	\$45,40
BL-P4-0019	150W	3000 K	12000	230 × 326 × 32	Siyah-Black	5	\$68,40
BL-P4-0021	150W	6500 K	12000	230 × 326 × 32	Siyah-Black	5	\$68,40
BL-P4-0022	200W	3000 K	16000	247 × 350 × 34	Siyah-Black	5	\$95,50
BL-P4-0024	200W	6500 K	16000	247 × 350 × 34	Siyah-Black	5	\$95,50
BL-P4-0025	300W	3000 K	24000	356 × 470 × 36.5	Siyah-Black	2	\$199,50
BL-P4-0027	300W	6500 K	24000	356 × 470 × 36.5	Siyah-Black	2	\$199,50
BL-P4-0028	400W	3000 K	32000	386 × 518 × 77	Siyah-Black	2	\$277,60
BL-P4-0030	400W	6500 K	32000	386 × 518 × 77	Siyah-Black	2	\$277,60

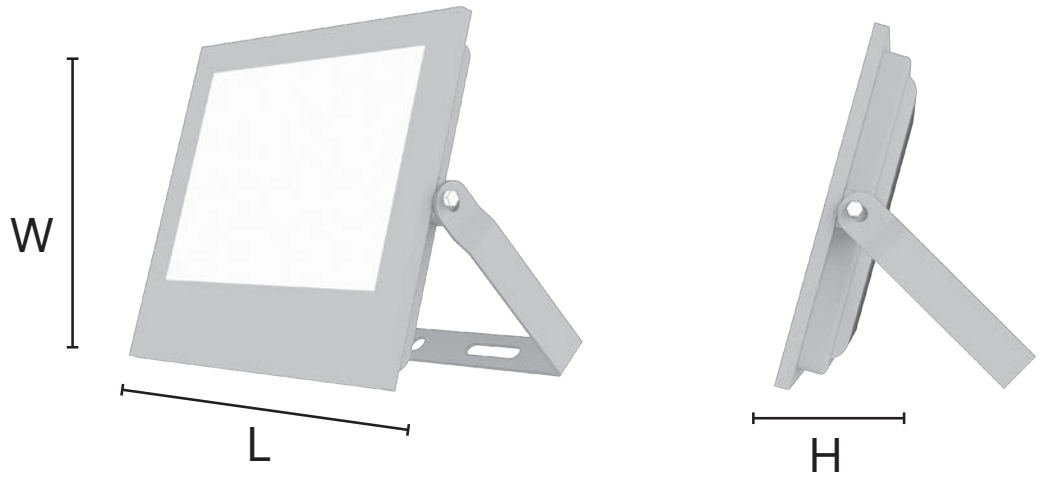

Teknik veri / Datasheet

LED SOKAK AYDINLATMA ARMATÜRÜ

LED STREET LIGHTING ARMATURE

Teknik Özellikler

Technical Specifications

Gövde : Alüminyum
Body : Aluminium

Cam : Temperli Cam
Glass : Tempered Glass

Renksel Geri Verim : 70
Color Rendering Index : 70

IP Derecesi : IP65
IP Rating : IP65

IK Derecesi : IK07
IK Rating : IK07

Elektriksel Koruma : Sınıf I
Electrical Protection : Class I



LED

3
YIL
GARANTİ

50.000
SAAT

IP65

LED SOKAK AYDINLATMA ARMATÜRÜ

Led Şehir Aydınlatma Armatürleri, yayalar ve sürücüler için azami görüş konforu ve yol güvenliği sağlar.

Sodyum ve cıva içeren lambalara göre düşük enerji gereksinimi, yüksek renksel geri verim, farklı renk sıcaklık seçenekleri, DIM ayar ve zamanlama otomasyon avantajlarına sahiptir. İlave olarak estetik ve kompakt armatür yapısı ile darbelere ve şoka dayanıklıdır. Uzun ömürlü ve bakım maliyetleri düşüktür.

LED STREET LIGHTING ARMATURE

Led City Lighting Fixtures to provide maximum visibility comfort and road safety for pedestrians and drivers.

Compared to lamps containing sodium and mercury, it has the advantages of low energy requirement, high colour rendering, different colour temperature options, DIM adjustment and timing automation. In addition, it is resistant to impacts and shocks with its aesthetic and compact armature structure, long life and low maintenance costs.



LED SOKAK AYDINLATMA ARMATÜRÜ

LED STREET LIGHTING ARMATURE

Ürün Kodu Product Code	Güç (W) Power	Renk Sıcaklığı (K) Color Temperature	Işık Akısı (Lm) Luminous Flux	Boyutlar (WxLxH) mm Dimensions	Renk Color	Koli Adeti Quantity in Carton	Fiyat Price
BL-C2-2001	60W	3000 K	5400	150 × 400 × 63	Gri	4	\$85,15
BL-C2-2007	60W	4000 K	5400	150 × 400 × 63	Gri	4	\$85,15
BL-C2-2002	60W	6500 K	5400	150 × 400 × 63	Gri	4	\$85,15
BL-C2-2003	90W	3000 K	8100	165 × 465 × 63	Gri	4	\$98,65
BL-C2-2008	90W	4000 K	8100	165 × 465 × 63	Gri	4	\$98,65
BL-C2-2004	90W	6500 K	8100	165 × 465 × 63	Gri	4	\$98,65
BL-C2-2005	120W	3000 K	10800	180 × 585 × 73	Gri	4	\$133,80
BL-C2-2009	120W	4000 K	10800	180 × 585 × 73	Gri	4	\$133,80
BL-C2-2006	120W	6500 K	10800	180 × 585 × 73	Gri	4	\$133,80

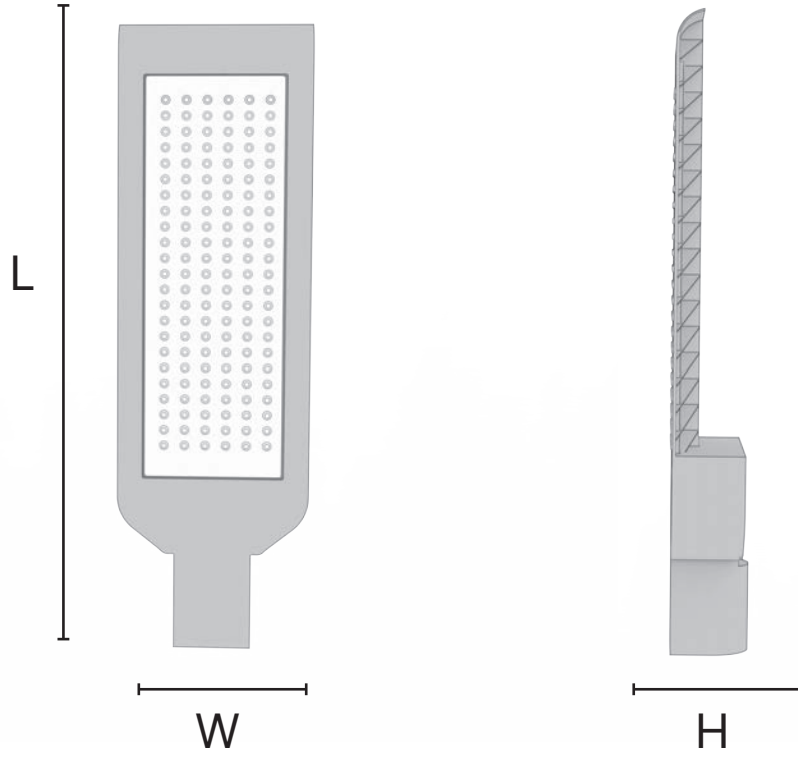

Teknik veri / Datasheet

DEKORATİF BAHÇE AYDINLATMA DİREKLERİ DECORATIVE GARDEN LIGHTING POLES

Teknik Özellikler Technical Specifications

Gövde : ABS
Body : ABS

IP Derecesi : IP54
IP Rating : IP54

Kullanım : Tasarruflu/Led Ampul
Usage : Energy Saving/Led Bulb



DEKORATİF BAHÇE AYDINLATMA DİREKLERİ

Zarif ve modern tasarım. Hafif, dayanıklı polimer gövde ve opal difüzör. IP54 Ürün standartları, herhangi bir açıdan katı cisimlere ve su sıçramalarına karşı koruma sağlar. 220-240V şebeke gücü, 1 x E27 (ampul dahil değildir.) Peyzajlı bahçeler, şehir parkları, garaj girişleri ve teras tipi yapılar için ideal, kolay ve hızlı kurulum. Montaj aparatları bu ürünle birlikte verilmektedir.

DECORATIVE GARDEN LIGHTING POLES

Elegant and modern design. Lightweight, durable polymer body and opal diffuser. IP54 Product standards provide protection against solid objects and splashes from any angle. 220-240V mains power, 1 x E27 (bulb not included.) Easy and fast installation, ideal for landscaped gardens, city parks, garage entrances and terrace type structures. Mounting tools are supplied with this product.



DEKORATİF BAHÇE AYDINLATMA DİREKLERİ DECORATIVE GARDEN LIGHTING POLES

Ürün Kodu Product Code	Renk Color	Boyutlar (ØxL) cm Dimensions	Gövde Body	Koli Adeti Quantity in Carton	Fiyat Price
BR-BA004	Siyah	11,5 × 29 cm	ABS	1	Fiyat Sorunuz
BR-BA005	Siyah	11,5 × 41 cm	ABS	1	Fiyat Sorunuz
BR-BA006	Siyah	11,5 × 29 cm	ABS	1	Fiyat Sorunuz
BR-BA007	Siyah	11,5 × 41 cm	ABS	1	Fiyat Sorunuz

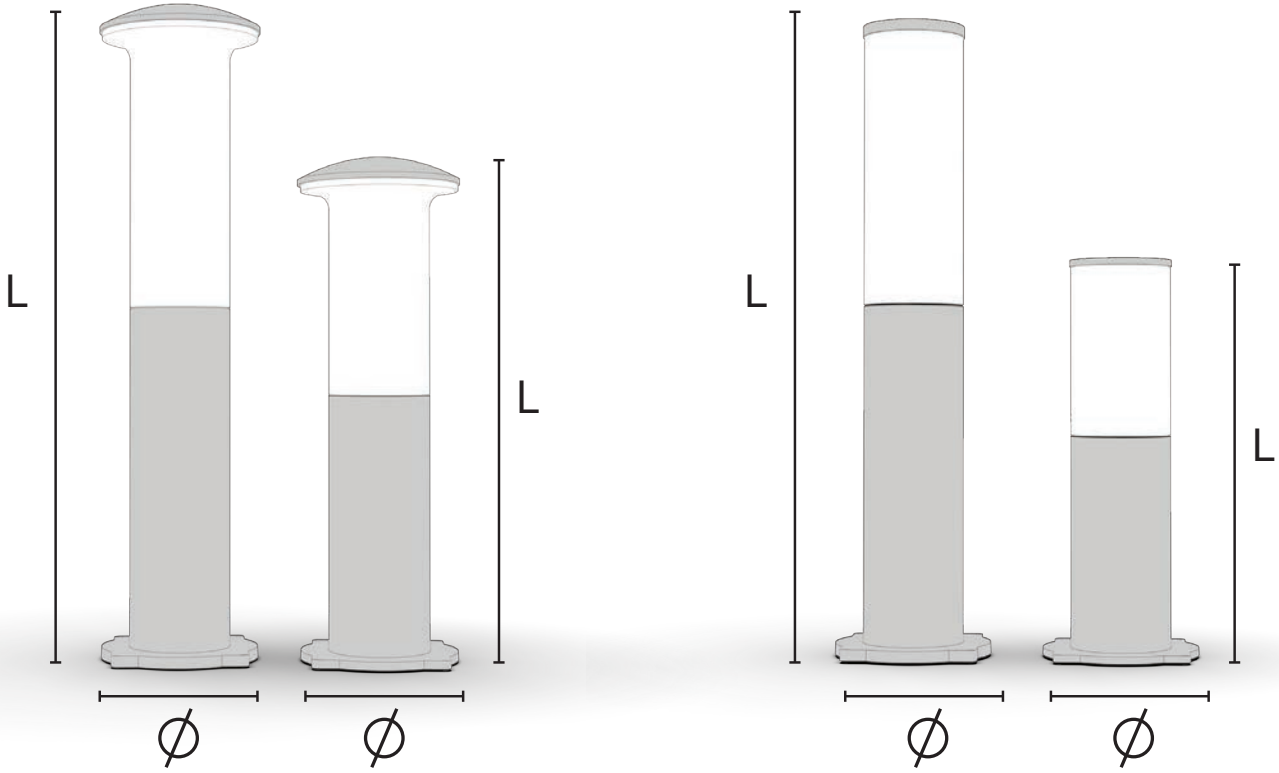

Teknik veri / Datasheet

SOLAR SOKAK AYDINLATMA ARMATÜRÜ

SOLAR STREET LIGHTING ARMATURE

Teknik Özellikler

Technical Specifications

Gövde : ABS
Body : ABS

Cam : Polikarbonat Cam
Glass : Polycarbonate Glass

Renksel Geri Verim : 80
Color Rendering Index : 80

IP Derecesi : IP65
IP Rating : IP65

IK Derecesi : IK07
IK Rating : IK07

Elektriksel Koruma : Sınıf I
Electrical Protection : Class I



LED

3
YIL
GARANTİ

50.000
SAAT

IP65



SOLAR SOKAK AYDINLATMA ARMATÜRÜ

Alüminyum alaşımlı şık tasarım. Yeni ısı dağıtım ve işleme teknolojisi ile gün boyunca elektrik enerjisi depolar. Su geçirmez (IP65) oksidasyon önleyici özellikleri ile korozyona ve dış etkenlere dayanıklıdır.

SOLAR STREET LIGHTING ARMATURE

Stylish design with aluminium alloy. It stores electrical energy throughout the day with its new heat distribution and processing technology. It is resistant to corrosion and external factors with its waterproof (IP65) anti-oxidation properties.



SOLAR SOKAK AYDINLATMA ARMATÜRÜ

SOLAR STREET LIGHTING ARMATURE

Ürün Kodu Product Code	Güç (W) Power	Renk Sıcaklığı (K) Color Temperature	Işık Akısı (Lm) Luminous Flux	Boyutlar (WxLxH) mm Dimensions	Renk Color	Koli Adeti Quantity in Carton	Fiyat Price
BL-SP-0010	80W	3000 K	1150	240 × 725 × 45	Siyah	10	\$90,15
BL-SP-0011	80W	4000 K	1150	240 × 725 × 45	Siyah	10	\$90,15
BL-SP-0012	80W	6500 K	1150	240 × 725 × 45	Siyah	10	\$90,15
BL-SP-0013	100W	3000 K	1450	240 × 820 × 60	Siyah	5	\$114,70
BL-SP-0014	100W	4000 K	1450	240 × 820 × 60	Siyah	5	\$114,70
BL-SP-0015	100W	6500 K	1450	240 × 820 × 60	Siyah	5	\$114,70

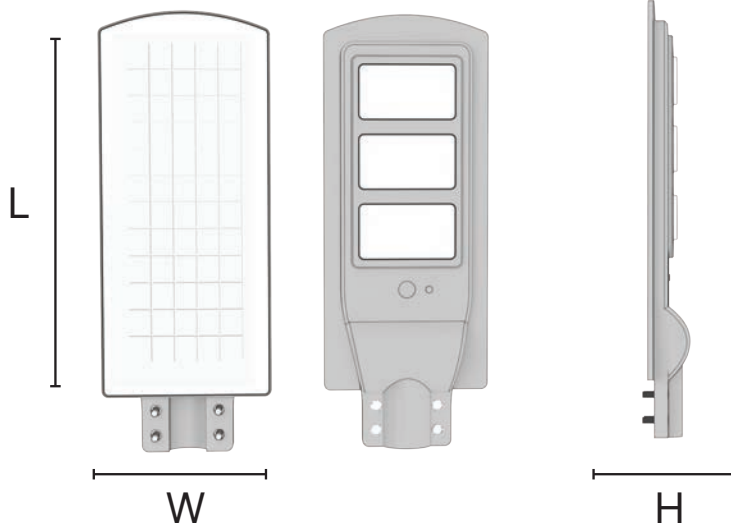

Teknik veri / Datasheet

LED RAY SPOT

LED RAIL SPOT

Teknik Özellikler Technical Specifications

Gövde : Alüminyum
Body : Aluminium

Cam : Akrilik
Glass : Acrylic

Renksel Geri Verim : 80
Color Rendering Index : 80

IP Derecesi : IP20
IP Rating : IP20

IK Derecesi : IK03
IK Rating : IK03

Elektriksel Koruma : Sınıf I
Electrical Protection : Class I



LED

2
YIL
GARANTİ

50.000
SAAT

LED RAY SPOT

LED Ray Spotlar; başta mağaza, müze, sahne, kafe, restoran, ofis vb. birçok yerde kullanılan aydınlatma armatürleridir. Tavana veya duvara monte edilmiş ray aparatı üzerinde hareket edebilir ve kendi ekseninde 360° yön değiştirerek vitrin, raf, stand ve reyon gibi belirli bölgeleri aydınlatarak dikkat çekerler.

LED Ray Spotlar, düşük enerji tüketerek yüksek ışık gücü sağlarken, uzun kullanım ömrüne ve estetik bir görünüme sahiptir.

LED RAIL SPOT

LED Rail Spots; mainly for the shop, museum, stage, cafe, restaurant, office etc. They are lighting fixtures used in many places. They can move on the ceiling or wall-mounted rail apparatus and change direction 360° on their axis, attracting attention by illuminating certain areas such as showcases, shelves, stands and sections.

LED Rail Spots provide high light power by consuming low energy and have a long service life and aesthetic appearance.



LED RAY SPOT MONOFAZE

LED RAIL SPOT MONOPHASE

Ürün Kodu Product Code	Güç (W) Power	Renk Sıcaklığı (K) Color Temperature	Işık Akısı (Lm) Luminous Flux	Boyutlar (Ø) mm Dimensions	Renk Color	Koli Adeti Quantity in Carton	Fiyat Price
BL-RS-0001	40W	3000 K	4000	115	Siyah-Black	24	Fiyat Sorunuz
BL-RS-0002	40W	4000 K	4000	115	Siyah-Black	24	Fiyat Sorunuz
BL-RS-0003	40W	6500 K	4000	115	Siyah-Black	24	Fiyat Sorunuz
BL-RS-1001	40W	3000 K	4000	115	Beyaz-White	24	Fiyat Sorunuz
BL-RS-1002	40W	4000 K	4000	115	Beyaz-White	24	Fiyat Sorunuz
BL-RS-1003	40W	6500 K	4000	115	Beyaz-White	24	Fiyat Sorunuz
BL-RS-1004	20W	3000 K	2000	115	Siyah-Black	24	Fiyat Sorunuz
BL-RS-1005	20W	4000 K	2000	115	Siyah-Black	24	Fiyat Sorunuz
BL-RS-1006	20W	6500 K	2000	115	Siyah-Black	24	Fiyat Sorunuz
BL-RS-1007	20W	3000 K	2000	115	Beyaz-White	24	Fiyat Sorunuz
BL-RS-1008	20W	4000 K	2000	115	Beyaz-White	24	Fiyat Sorunuz
BL-RS-1009	20W	6500 K	2000	115	Beyaz-White	24	Fiyat Sorunuz

MONOFAZE RAY

MONOPHASE RAIL

Ürün Kodu Product Code	Boyutlar (Metre) Dimensions	Renk Color	Koli Adeti Quantity in Carton	Fiyat Price
BR-RSA-0001	1	Beyaz-White	20	\$10,80
BR-RSA-0002	2	Beyaz-White	20	\$21,60
BR-RSA-0003	3	Beyaz-White	20	\$32,40
BR-RSA-0004	1	Siyah-Black	20	\$10,80
BR-RSA-0005	2	Siyah-Black	20	\$21,60
BR-RSA-0006	3	Siyah-Black	20	\$32,40

EK PARÇA

ATTACHMENT

Ürün Kodu Product Code	Renk Color	Koli Adeti Quantity in Carton	Fiyat Price
BR-RSA-0008	Siyah-Black	100	\$3,10
BR-RSA-0011	Beyaz-White	100	\$3,10

L PARÇA

L PIECE

Ürün Kodu Product Code	Renk Color	Koli Adeti Quantity in Carton	Fiyat Price
BR-RSA-0009	Siyah-Black	100	Fiyat Sorunuz
BR-RSA-0012	Beyaz-White	100	Fiyat Sorunuz

MONOFAZE SOKET

MONOPHASE SOCKET

Ürün Kodu Product Code	Renk Color	Koli Adeti Quantity in Carton	Fiyat Price
BR-RSA-0007	Siyah-Black	200	Fiyat Sorunuz
BR-RSA-0010	Beyaz-White	200	Fiyat Sorunuz



Teknik veri / Datasheet



Teknik veri / Datasheet

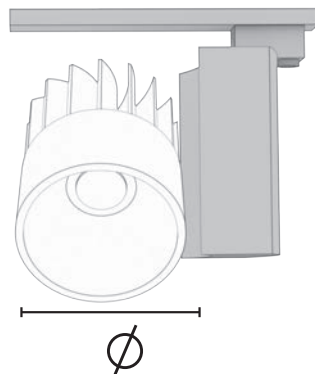
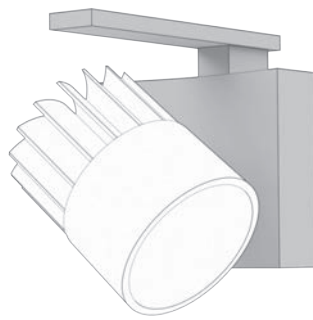

LED YÜKSEK TAVAN ARMATÜR

LED HIGH CEILING ARMATURE

Teknik Özellikler

Technical Specifications

Gövde : Alüminyum
Body : Aluminium

Difüzör : Polikarbon Cam
Diffuser : Polycarbon Glass

Renksel Geri Verim : 80
Color Rendering Index : 80

Sürücü : Philips
Driver : Philips

IP Derecesi : IP54
IP Rating : IP54

IK Derecesi : IK03
IK Rating : IK03

Elektriksel Koruma : Sınıf I
Electrical Protection : Class I

Çalışma Sıcaklığı : -20°C / 45°C
Operating Temp. Range : -20°C / 45°C



LED

3 YIL GARANTİ

50.000 SAAT

IP54

LED YÜKSEK TAVAN ARMATÜR

Yüksek tavanlı, erişimi ve bakımı zor olan endüstriyel ve ticari alanları aydınlatmaya yönelik, uzun ömürlü, yüksek enerji tasarrufu ve optimum performans sunar. Estetik, dayanıklılık ve maliyet avantajları sağlar.

LED HIGH CEILING ARMATURE

It offers long-lasting, high energy saving and optimum performance for illuminating industrial and commercial areas with high ceilings, which are difficult to access and maintain. It provides aesthetic, durability and cost advantages.



LED YÜKSEK TAVAN ARMATÜR LED HIGH CEILING ARMATURE

Ürün Kodu Product Code	Güç (W) Power	Renk Sıcaklığı (K) Color Temperature	Işık Akısı (Lm) Luminous Flux	Boyutlar (WxLxH) mm Dimensions	Koli Adeti Quantity in Carton	Fiyat Price
BL-Y1-0001	55W	3000 K	6600	132×600×75	1	\$103,75
BL-Y1-0002	55W	4000 K	6600	132×600×75	1	\$103,75
BL-Y1-0003	55W	6500 K	6600	132×600×75	1	\$103,75
BL-Y1-0004	90W	3000 K	10800	132×1000×75	1	\$192,40
BL-Y1-0005	90W	4000 K	10800	132×1000×75	1	\$192,40
BL-Y1-0006	90W	6500 K	10800	132×1000×75	1	\$192,40
BL-Y1-0007	110W	3000 K	13200	132×1200×75	1	\$200,55
BL-Y1-0008	110W	4000 K	13200	132×1200×75	1	\$200,55
BL-Y1-0009	110W	6500 K	13200	132×1200×75	1	\$200,55
BL-Y1-0010	135W	3000 K	16200	132×1500×75	1	\$266,60
BL-Y1-0011	135W	4000 K	16200	132×1500×75	1	\$266,60
BL-Y1-0012	135W	6500 K	16200	132×1500×75	1	\$266,60

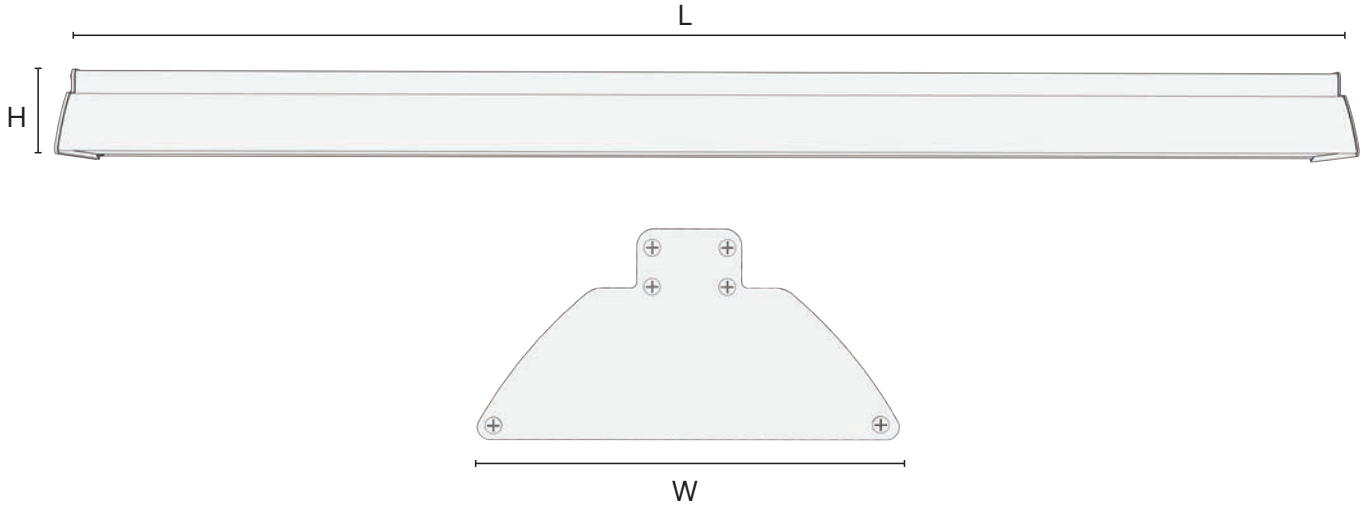

Teknik veri / Datasheet

LED LINEER ARMATÜR

LED LINEAR ARMATURE

Teknik Özellikler

Technical Specifications

Gövde : Alüminyum
Body : Aluminium

Difüzör : Polikarbon Cam
Diffuser : Polycarbon Glass

Renksel Geri Verim : 80
Color Rendering Index : 80

IP Derecesi : IP54
IP Rating : IP54

IK Derecesi : IK03
IK Rating : IK03

Elektriksel Koruma : Sınıf I
Electrical Protection : Class I

Çalışma Sıcaklığı : -20°C / 45°C
Operating Temp. Range : -20°C / 45°C

Sıva Üstü Üründe 1m Askı Teli
1m Hanger Wire for Surface Mounted Product

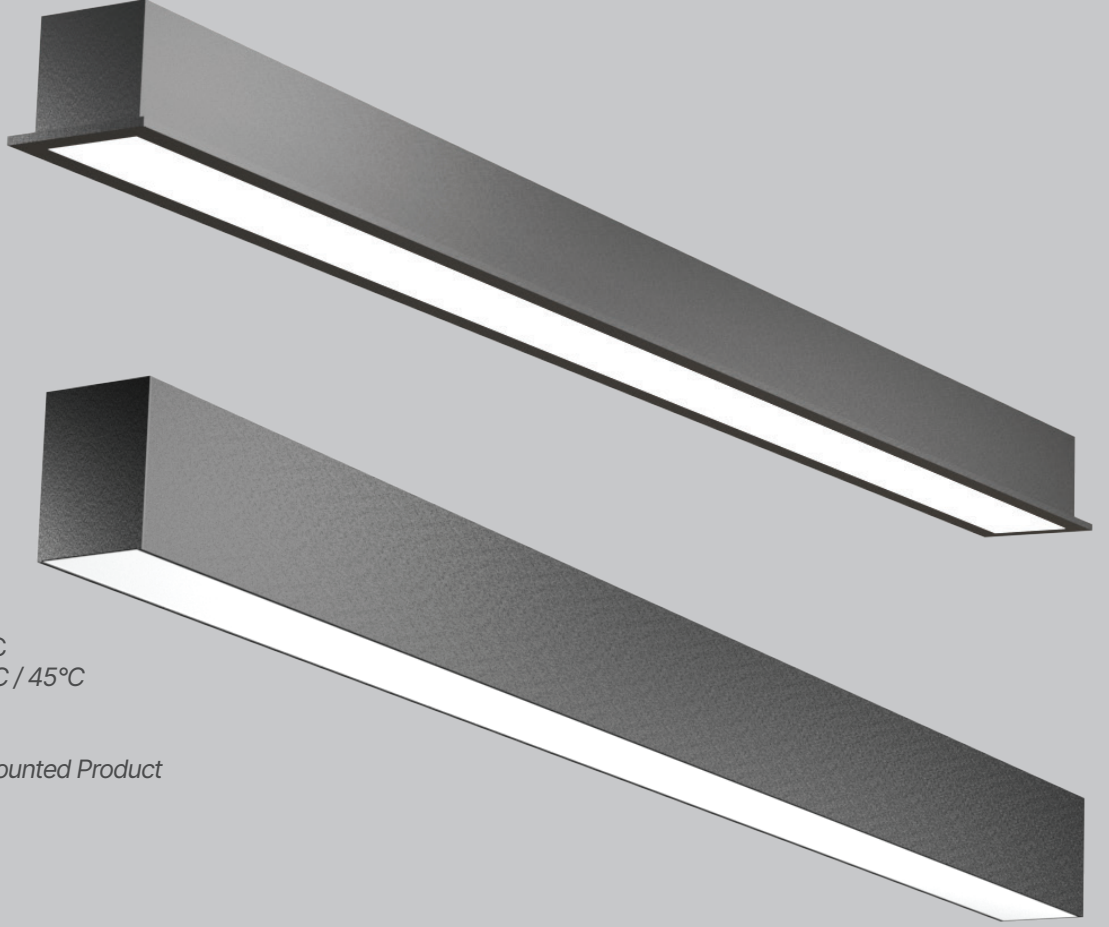

LED

3
YIL
GARANTİ

50.000
SAAT

IP54

LED LINEER ARMATÜR

Led lineer armatürler, aydınlatmada üst seviye ışıklandırma, dekoratif ortam ve sağlıklı çalışma performansı sağlamaktadır.

Yüksek kaliteli alüminyum gövde, renk ve boyut alternatifleri sunar.

Led Lineer armatürler, düşük enerji kullanımı ve uzun ömürlü olması nedeniyle son derece verimli çalışır.

Sıva altında, sıva üstünde veya sarkıt aksesuarlar ile rahatlıkla kullanılabilir.

LED LINEAR ARMATURE

Led linear luminaires provide high level lighting, decorative environment and healthy working performance in lighting.

It offers high quality Aluminium body, color and size alternatives.

Led Linear luminaires will be extremely efficient due to low energy use and being in use.

It can be used under plaster, on surface or with pendant accessories.



LED LINEER SIVA ALTI ARMATÜR

LED LINEAR FLUSH MOUNTED ARMATURE

Ürün Kodu Product Code	Güç (W) Power	Renk Sıcaklığı (K) Color Temperature	Işık Akısı (Lm) Luminous Flux	Boyutlar (WxLxH) mm Dimensions	Koli Adeti Quantity in Carton	Fiyat Price
BL-L1-1001	15W	4000 K	1800	66 × 650 × 90	1	\$106,15
BL-L1-1002	15W	6500 K	1800	66 × 650 × 90	1	\$106,15
BL-L1-1003	20W	4000 K	2400	66 × 650 × 90	1	\$109,75
BL-L1-1004	20W	6500 K	2400	66 × 650 × 90	1	\$109,75
BL-L1-1005	30W	4000 K	3600	66 × 1250 × 90	1	\$179,40
BL-L1-1006	30W	6500 K	3600	66 × 1250 × 90	1	\$179,40
BL-L1-1007	40W	4000 K	4800	66 × 1250 × 90	1	\$182,95
BL-L1-1008	40W	6500 K	4800	66 × 1250 × 90	1	\$182,95
BL-L1-1009	45W	4000 K	5400	66 × 1550 × 90	1	\$219,75
BL-L1-1010	45W	6500 K	5400	66 × 1550 × 90	1	\$219,75
BL-L1-1011	50W	4000 K	6000	66 × 1550 × 90	1	\$228,65
BL-L1-1012	50W	6500 K	6000	66 × 1550 × 90	1	\$228,65

LED LINEER SIVA ÜSTÜ ARMATÜR

LED LINEAR SURFACE MOUNTED ARMATURE

Ürün Kodu Product Code	Güç (W) Power	Renk Sıcaklığı (K) Color Temperature	Işık Akısı (Lm) Luminous Flux	Boyutlar (WxLxH) mm Dimensions	Koli Adeti Quantity in Carton	Fiyat Price
BL-L1-2001	15W	4000 K	1800	66 × 600 × 90	1	\$96,25
BL-L1-2002	15W	6500 K	1800	66 × 600 × 90	1	\$96,25
BL-L1-2003	20W	4000 K	2400	66 × 600 × 90	1	\$99,75
BL-L1-2004	20W	6500 K	2400	66 × 600 × 90	1	\$99,75
BL-L1-2005	30W	4000 K	3600	66 × 1200 × 90	1	\$154,70
BL-L1-2006	30W	6500 K	3600	66 × 1200 × 90	1	\$154,70
BL-L1-2007	40W	4000 K	4800	66 × 1200 × 90	1	\$158,30
BL-L1-2008	40W	6500 K	4800	66 × 1200 × 90	1	\$158,30
BL-L1-2009	45W	4000 K	5400	66 × 1500 × 90	1	\$185,65
BL-L1-2010	45W	6500 K	5400	66 × 1500 × 90	1	\$185,65
BL-L1-2011	50W	4000 K	6000	66 × 1500 × 90	1	\$191,00
BL-L1-2012	50W	6500 K	6000	66 × 1500 × 90	1	\$191,00



Teknik veri / Datasheet

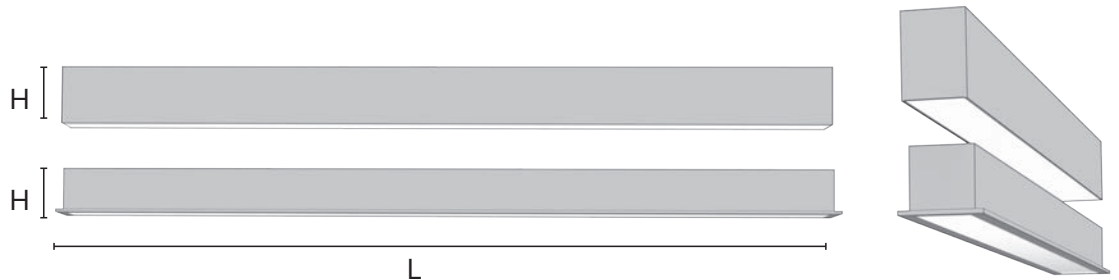

LENSLİ LINEER ARMATÜR

LINEAR ARMATURE WITH LENS

Teknik Özellikler

Technical Specifications

Gövde : Alüminyum
Body : Aluminium

Difüzör : Polikarbon Cam
Diffuser : Polycarbon Glass

Renksel Geri Verim : 80
Color Rendering Index : 80

IP Derecesi : IP54
IP Rating : IP54

IK Derecesi : IK03
IK Rating : IK03

Elektriksel Koruma : Sınıf I
Electrical Protection : Class I

Çalışma Sıcaklığı : -20°C / 45°C
Operating Temp. Range : -20°C / 45°C

Sıva Üstü Üründe 1m Askı Teli
1m Hanger Wire for Surface Mounted
Product

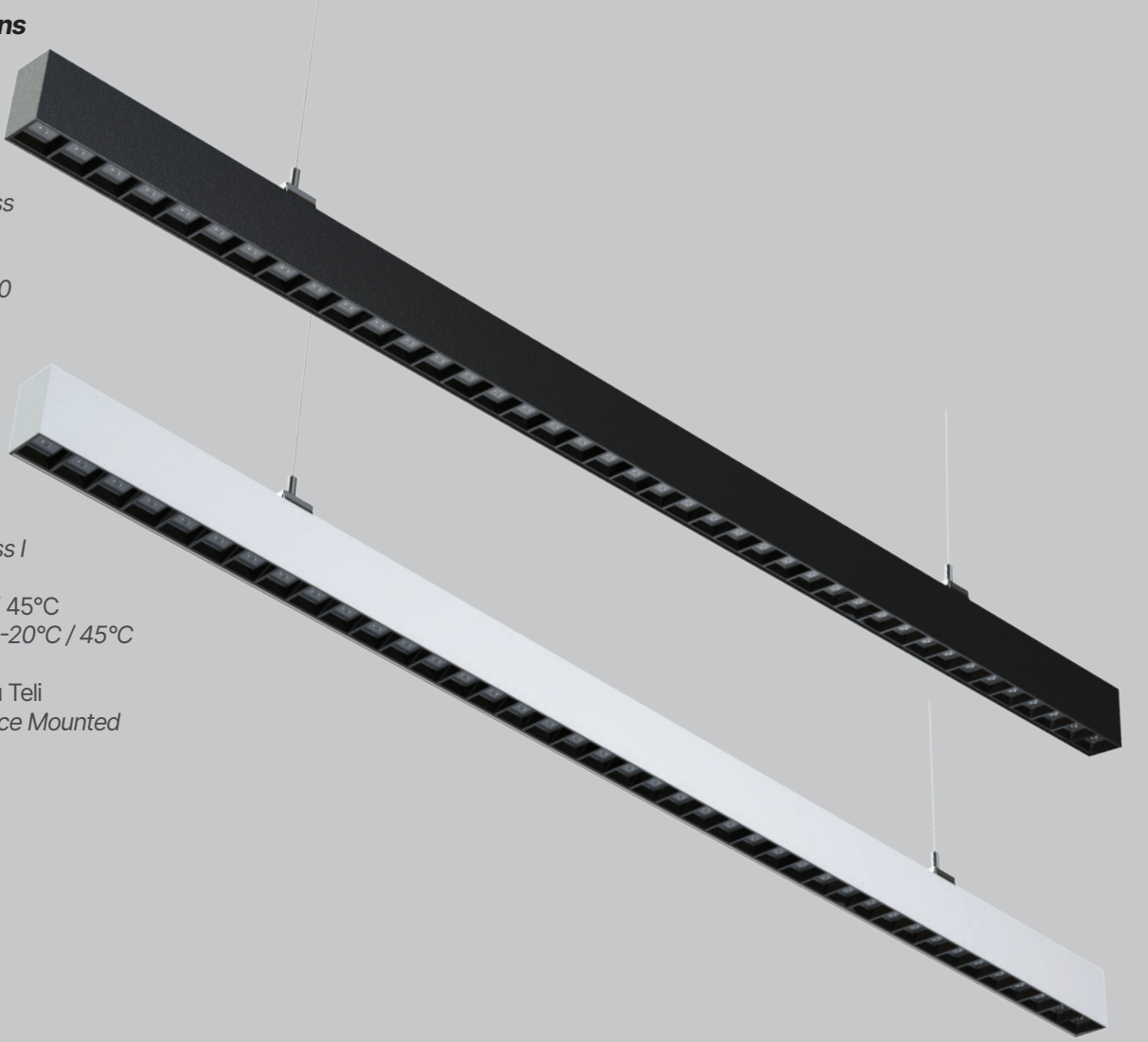

LED

3
YIL
GARANTİ

50.000
SAAT

IP54

LENSLİ LINEER ARMATÜR

Led lineer armatürler, aydınlatmada üst seviye ışıklandırma, dekoratif ortam ve sağlıklı çalışma performansı sağlamaktadır.

Yüksek kaliteli alüminyum gövde, renk ve boyut alternatifleri sunar.

Led Lineer armatürler, düşük enerji kullanımı ve uzun ömürlü olması nedeniyle son derece verimli çalışır.

Sıva altında, sıva üstünde veya sarkıt aksesuarlar ile rahatlıkla kullanılabilir.

LINEAR ARMATURE WITH LENS

Led linear luminaires provide high level lighting, decorative environment and healthy working performance in lighting.

It offers high quality Aluminium body, color and size alternatives.

Led Linear luminaires will be extremely efficient due to low energy use and being in use.

It can be used under plaster, on surface or with pendant accessories.



LENSLİ LED LINEER SIVA ALTI ARMATÜR

LED LINEAR FLUSH MOUNTED ARMATURE WITH LENS

Ürün Kodu Product Code	Güç (W) Power	Renk Sıcaklığı (K) Color Temperature	Işık Akısı (Lm) Luminous Flux	Boyutlar (WxLxH) mm Dimensions	Renk Color	Koli Adeti Quantity in Carton	Fiyat Price
BL-L2-1001	20W	4000 K	2000	66 × 600 × 90	Siyah-Black	1	\$53,25
BL-L2-1002	20W	6500 K	2000	66 × 600 × 90	Siyah-Black	1	\$53,25
BL-L2-1003	50W	4000 K	5000	66 × 1000 × 90	Siyah-Black	1	\$85,30
BL-L2-1004	50W	6500 K	5000	66 × 1000 × 90	Siyah-Black	1	\$85,30
BL-L2-1011	20W	4000 K	2000	66 × 600 × 90	Beyaz-White	1	\$53,25
BL-L2-1012	20W	6500 K	2000	66 × 600 × 90	Beyaz-White	1	\$53,25
BL-L2-1013	50W	4000 K	5000	66 × 1000 × 90	Beyaz-White	1	\$85,30
BL-L2-1014	50W	6500 K	5000	66 × 1000 × 90	Beyaz-White	1	\$85,30

LENSLİ LED LINEER SIVA ÜSTÜ ARMATÜR

LED LINEAR SURFACE MOUNTED ARMATURE WITH LENS

Ürün Kodu Product Code	Güç (W) Power	Renk Sıcaklığı (K) Color Temperature	Işık Akısı (Lm) Luminous Flux	Boyutlar (WxLxH) mm Dimensions	Renk Color	Koli Adeti Quantity in Carton	Fiyat Price
BL-L2-2001	20W	4000 K	2000	66 × 600 × 90	Siyah-Black	1	\$58,20
BL-L2-2002	20W	6500 K	2000	66 × 600 × 90	Siyah-Black	1	\$58,20
BL-L2-2003	50W	4000 K	5000	66 × 1000 × 90	Siyah-Black	1	\$95,35
BL-L2-2004	50W	6500 K	5000	66 × 1000 × 90	Siyah-Black	1	\$95,35
BL-L2-2011	20W	4000 K	2000	66 × 600 × 90	Beyaz-White	1	\$58,20
BL-L2-2012	20W	6500 K	2000	66 × 600 × 90	Beyaz-White	1	\$58,20
BL-L2-2013	50W	4000 K	5000	66 × 1000 × 90	Beyaz-White	1	\$95,35
BL-L2-2014	50W	6500 K	5000	66 × 1000 × 90	Beyaz-White	1	\$95,35



Teknik veri / Datasheet

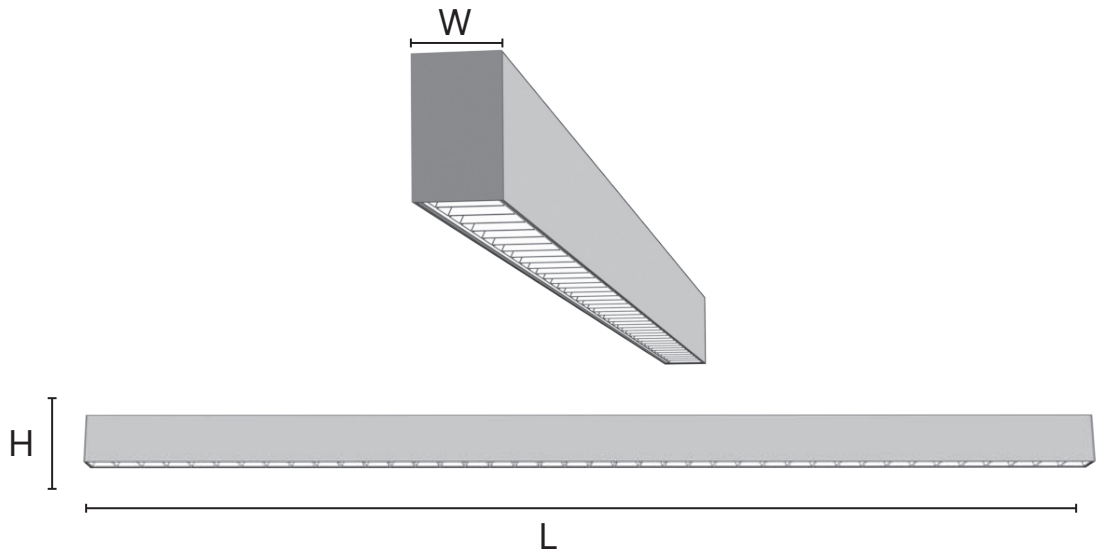

LED LEVEL ETANJ ARMATÜR

LED LEVEL WATERPROOF ARMATURE

Teknik Özellikler

Technical Specifications

Gövde : Polikarbonat
Body : Polycarbonate

Gövde Renkleri : Gri
Body Colors : Grey

Kapak : Polikarbonat
Cover : Polycarbonate

Kapak Rengi : Gri
Cover Color : Grey

Renksel Geri Verim : 80
Color Rendering Index : 80

IP Derecesi : IP65
IP Rating : IP65

IK Derecesi : IK09
IK Rating : IK09

Elektriksel Koruma : Sınıf II
Electrical Protection : Class II

Çalışma Sıcaklığı : -20°C / 45°C
Operating Temp. Range : -20°C / 45°C

3000 K OPSİYONDUR
L : 1500 MM OPSİYONU VARDIR

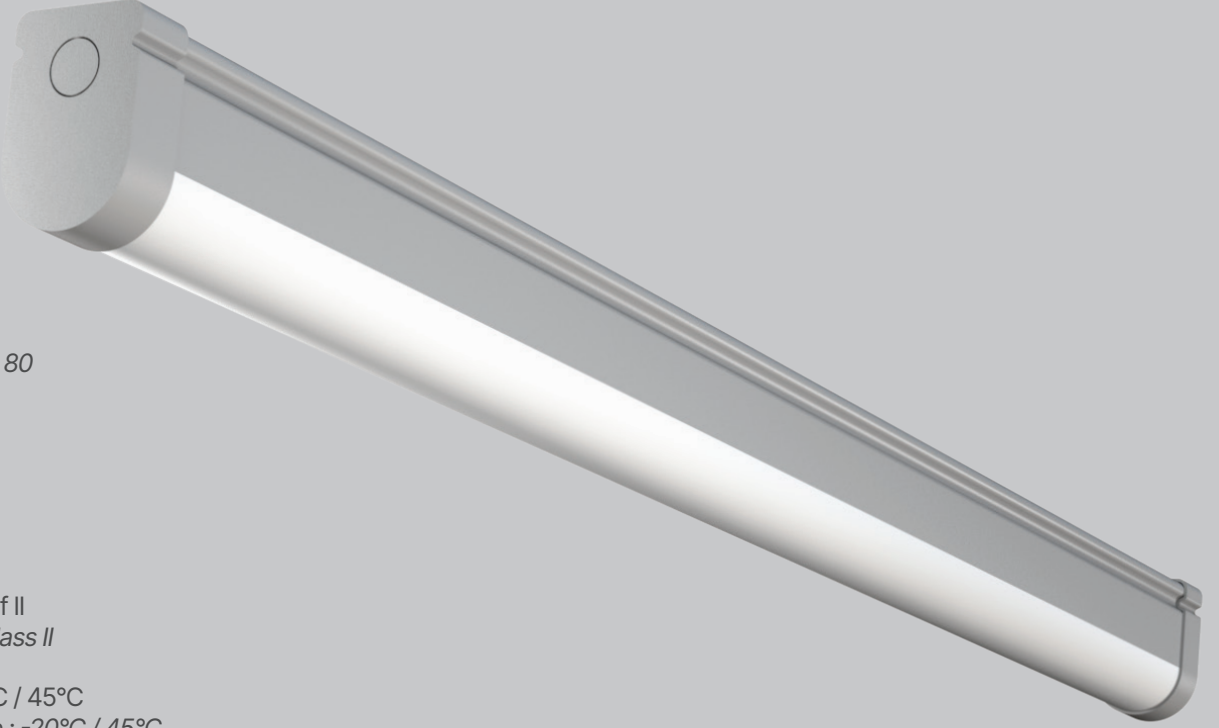

LED

3
YIL
GARANTİ

50.000
SAAT

IP65



LED LEVEL ETANJ ARMATÜR

IP65 koruma standartlarında polikarbon gövde ve difüzör yapısı; neme, toza, doğrudan su ve darbelere karşı etkindir. Led aydınlatma ve difüzör tasarımı, her türlü alanda yüksek ışık verimliliği ve konforlu görüş sağlar. Kolay montaj ve bakım imkanları sunar.

LED LEVEL WATERPROOF ARMATURE

Polycarbonate body and diffuser structure in IP65 protection standards; It is effective against moisture, dust, direct water and impacts. Led lighting and diffuser design provide high luminous efficiency and comfortable vision in all kinds of areas. It offers easy installation and maintenance opportunities.



LED LEVEL ETANJ ARMATÜR

LED LEVEL WATERPROOF ARMATURE

Ürün Kodu Product Code	Güç (W) Power	Renk Sıcaklığı (K) Color Temperature	Işık Akısı (Lm) Luminous Flux	Boyutlar (WxLxH) mm Dimensions	Opsiyonlar Options	Koli Adeti Quantity in Carton	Fiyat Price
BL-E1-0009	15W	4000 K	1350	44 × 600 × 64	-	12	\$ 63,25
BL-E1-0009-1H	15W	4000 K	1350	44 × 600 × 64	1 Saat Acil Kit	12	\$69,30
BL-E1-0009-3H	15W	4000 K	1350	44 × 600 × 64	3 Saat Acil Kit	12	\$76,25
BL-E1-0009-RS	15W	4000 K	1350	44 × 600 × 64	Radar Sensörlü	12	\$27,70
BL-E1-0009-RS-1H	15W	4000 K	1350	44 × 600 × 64	Radar Sensörlü 1 Saat Acil Kit	12	\$66,10
BL-E1-0009-RS-3H	15W	4000 K	1350	44 × 600 × 64	Radar Sensörlü 3 Saat Acil Kit	12	\$79,10
BL-E1-0013	15W	6500 K	1350	44 × 600 × 64	-	12	\$18,00
BL-E1-0013-1H	15W	6500 K	1350	44 × 600 × 64	1 Saat Acil Kit	12	\$63,25
BL-E1-0013-3H	15W	6500 K	1350	44 × 600 × 64	3 Saat Acil Kit	12	\$76,25
BL-E1-0013-RS	15W	6500 K	1350	44 × 600 × 64	Radar Sensörlü	12	\$27,70
BL-E1-0013-RS-1H	15W	6500 K	1350	44 × 600 × 64	Radar Sensörlü 1 Saat Acil Kit	12	\$66,10
BL-E1-0013-RS-3H	15W	6500 K	1350	44 × 600 × 64	Radar Sensörlü 3 Saat Acil Kit	12	\$79,10
BL-E1-0011	30W	4000 K	2700	44 × 1200 × 64	-	12	\$30,70
BL-E1-0011-1H	30W	4000 K	2700	44 × 1200 × 64	1 Saat Acil Kit	12	\$73,90
BL-E1-0011-3H	30W	4000 K	2700	44 × 1200 × 64	3 Saat Acil Kit	12	\$87,85
BL-E1-0011-RS	30W	4000 K	2700	44 × 1200 × 64	Radar Sensörlü	12	\$58,30
BL-E1-0011-RS-1H	30W	4000 K	2700	44 × 1200 × 64	Radar Sensörlü 1 Saat Acil Kit	12	\$76,75
BL-E1-0011-RS-3H	30W	4000 K	2700	44 × 1200 × 64	Radar Sensörlü 3 Saat Acil Kit	12	\$90,70
BL-E1-0015	30W	6500 K	2700	44 × 1200 × 64	-	12	\$30,70
BL-E1-0015-1H	30W	6500 K	2700	44 × 1200 × 64	1 Saat Acil Kit	12	\$73,90
BL-E1-0015-3H	30W	6500 K	2700	44 × 1200 × 64	3 Saat Acil Kit	12	\$87,85
BL-E1-0015-RS	30W	6500 K	2700	44 × 1200 × 64	Radar Sensörlü	12	\$58,30
BL-E1-0015-RS-1H	30W	6500 K	2700	44 × 1200 × 64	Radar Sensörlü 1 Saat Acil Kit	12	\$76,75
BL-E1-0015-RS-3H	30W	6500 K	2700	44 × 1200 × 64	Radar Sensörlü 3 Saat Acil Kit	12	\$90,70



Teknik veri / Datasheet

LED LEVEL ETANJ ARMATÜR TSE

LED LEVEL WATERPROOF ARMATURE TSE

Teknik Özellikler

Technical Specifications

Gövde : Polikarbonat
Body : Polycarbonate

Gövde Renkleri : Gri
Body Colors : Grey

Kapak : Polikarbonat
Cover : Polycarbonate

Kapak Rengi : Gri
Cover Color : Grey

Renksel Geri Verim : 80
Color Rendering Index : 80

IP Derecesi : IP65
IP Rating : IP65

IK Derecesi : IK09
IK Rating : IK09

Elektriksel Koruma : Sınıf II
Electrical Protection : Class II

Çalışma Sıcaklığı : -20°C / 45°C
Operating Temp. Range : -20°C / 45°C

3000 K OPSİYONDUR
L : 1500 MM OPSİYONU VARDIR

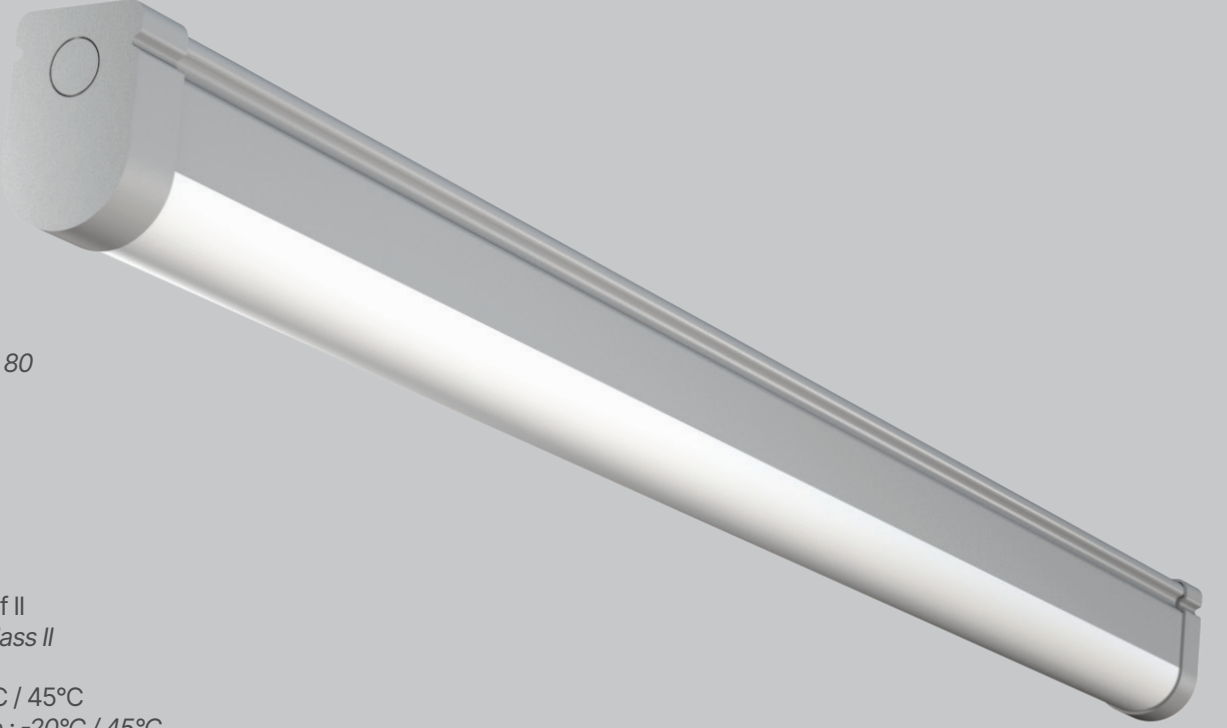

LED

3
YIL
GARANTİ

50.000
SAAT

IP65



LED LEVEL ETANJ ARMATÜR TSE

IP65 koruma standartlarında polikarbon gövde ve difüzör yapısı; neme, toza, doğrudan su ve darbelere karşı etkindir. Led aydınlatma ve difüzör tasarımı, her türlü alanda yüksek ışık verimliliği ve konforlu görüş sağlar. Kolay montaj ve bakım imkanları sunar.

LED LEVEL WATERPROOF ARMATURE TSE

Polycarbonate body and diffuser structure in IP65 protection standards; It is effective against moisture, dust, direct water and impacts. Led lighting and diffuser design provide high luminous efficiency and comfortable vision in all kinds of areas. It offers easy installation and maintenance opportunities.



LED LEVEL ETANJ ARMATÜR TSE

LED LEVEL WATERPROOF ARMATURE TSE

Ürün Kodu Product Code	Güç (W) Power	Renk Sıcaklığı (K) Color Temperature	Işık Akısı (Lm) Luminous Flux	Boyutlar (WxLxH) mm Dimensions	Opsiyonlar Options	Koli Adeti Quantity in Carton	Fiyat Price
BLT-E1-0009	15W	4000 K	1500	44 × 600 × 64	-	12	\$37,65
BLT-E1-0009-1H	15W	4000 K	1500	44 × 600 × 64	1 Saat Acil Kit	12	\$63,25
BLT-E1-0009-3H	15W	4000 K	1500	44 × 600 × 64	3 Saat Acil Kit	12	\$76,25
BLT-E1-0009-RS	15W	4000 K	1500	44 × 600 × 64	Radar Sensörlü	12	\$65,80
BLT-E1-0009-RS-1H	15W	4000 K	1500	44 × 600 × 64	Radar Sensörlü 1 Saat Acil Kit	12	\$66,10
BLT-E1-0009-RS-3H	15W	4000 K	1500	44 × 600 × 64	Radar Sensörlü 3 Saat Acil Kit	12	\$79,10
BLT-E1-0013	15W	6500 K	1500	44 × 600 × 64	-	12	\$37,65
BLT-E1-0013-1H	15W	6500 K	1500	44 × 600 × 64	1 Saat Acil Kit	12	\$63,25
BLT-E1-0013-3H	15W	6500 K	1500	44 × 600 × 64	3 Saat Acil Kit	12	\$76,25
BLT-E1-0013-RS	15W	6500 K	1500	44 × 600 × 64	Radar Sensörlü	12	\$65,80
BLT-E1-0013-RS-1H	15W	6500 K	1500	44 × 600 × 64	Radar Sensörlü 1 Saat Acil Kit	12	\$66,10
BLT-E1-0013-RS-3H	15W	6500 K	1500	44 × 600 × 64	Radar Sensörlü 3 Saat Acil Kit	12	\$79,10
BLT-E1-0011	30W	4000 K	3000	44 × 1200 × 64	-	12	\$51,70
BLT-E1-0011-1H	30W	4000 K	3000	44 × 1200 × 64	1 Saat Acil Kit	12	\$73,90
BLT-E1-0011-3H	30W	4000 K	3000	44 × 1200 × 64	3 Saat Acil Kit	12	\$87,85
BLT-E1-0011-RS	30W	4000 K	3000	44 × 1200 × 64	Radar Sensörlü	12	\$80,50
BLT-E1-0011-RS-1H	30W	4000 K	3000	44 × 1200 × 64	Radar Sensörlü 1 Saat Acil Kit	12	\$76,75
BLT-E1-0011-RS-3H	30W	4000 K	3000	44 × 1200 × 64	Radar Sensörlü 3 Saat Acil Kit	12	\$90,70
BLT-E1-0015	30W	6500 K	3000	44 × 1200 × 64	-	12	\$51,70
BLT-E1-0015-1H	30W	6500 K	3000	44 × 1200 × 64	1 Saat Acil Kit	12	\$73,90
BLT-E1-0015-3H	30W	6500 K	3000	44 × 1200 × 64	3 Saat Acil Kit	12	\$87,85
BLT-E1-0015-RS	30W	6500 K	3000	44 × 1200 × 64	Radar Sensörlü	12	\$80,50
BLT-E1-0015-RS-1H	30W	6500 K	3000	44 × 1200 × 64	Radar Sensörlü 1 Saat Acil Kit	12	\$76,75
BLT-E1-0015-RS-3H	30W	6500 K	3000	44 × 1200 × 64	Radar Sensörlü 3 Saat Acil Kit	12	\$90,70

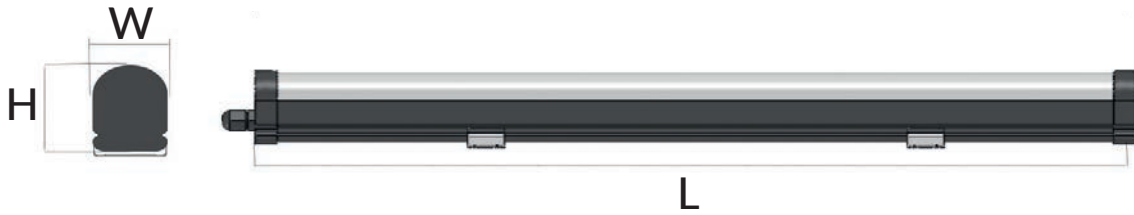

Teknik veri / Datasheet



LED ELIPS ETANJ ARMATÜR

LED ELIPS WATERPROOF ARMATURE

Teknik Özellikler

Technical Specifications

Gövde : Polikarbonat
Body : Polycarbonate

Gövde Renkleri : Gri
Body Colors : Grey

Kapak : Polikarbonat
Cover : Polycarbonate

Kapak Rengi : Gri
Cover Color : Grey

Renksel Geri Verim : 80
Color Rendering Index : 80

IP Derecesi : IP65
IP Rating : IP65

IK Derecesi : IK09
IK Rating : IK09

Elektriksel Koruma : Sınıf II
Electrical Protection : Class II

Çalışma Sıcaklığı : -20°C / 45°C
Operating Temp. Range : -20°C / 45°C

3000 K OPSİYONDUR
L : 1500 MM OPSİYONU VARDIR

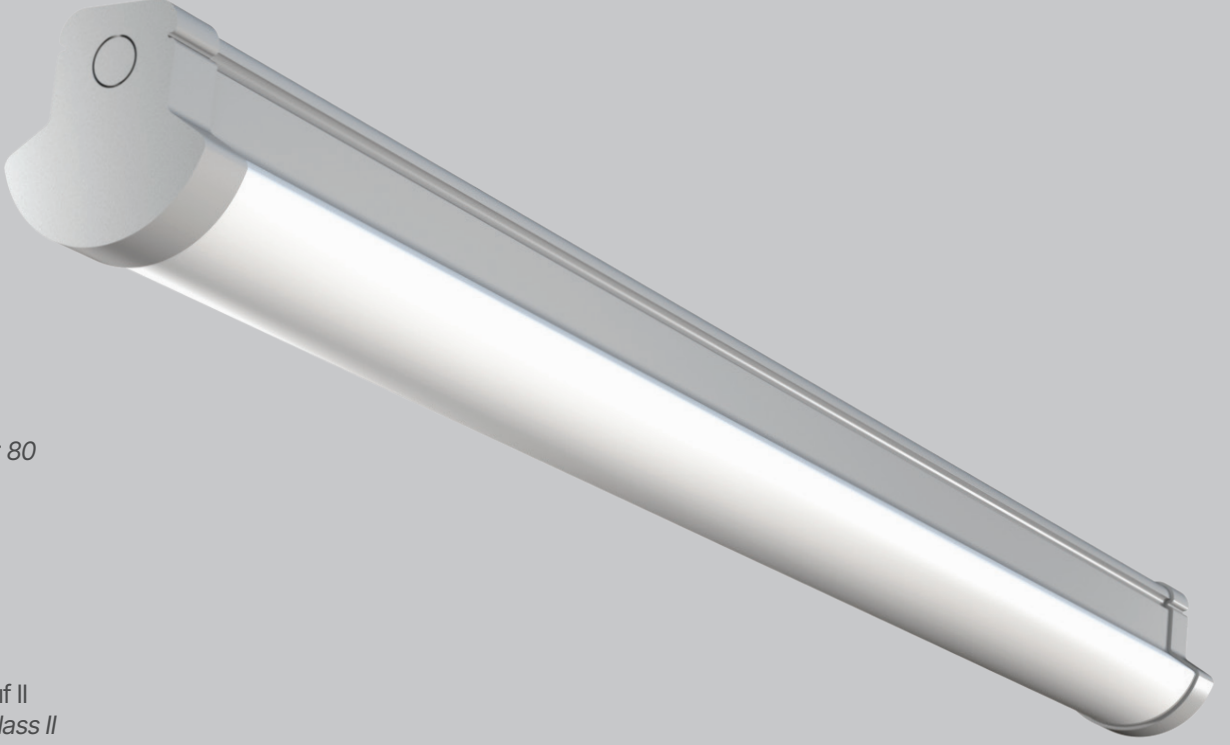

LED

3
YIL
GARANTİ

50.000
SAAT

IP65



LED ELIPS ETANJ ARMATÜR

IP65 koruma standartlarında polikarbon gövde ve difüzör yapısı; neme, toza, doğrudan su ve darbelere karşı etkindir. Led aydınlatma ve difüzör tasarımı, her türlü alanda yüksek ışık verimliliği ve konforlu görüş sağlar. Kolay montaj ve bakım imkanları sunar.

LED ELIPS WATERPROOF ARMATURE

Polycarbonate body and diffuser structure in IP65 protection standards; It is effective against moisture, dust, direct water and impacts. Led lighting and diffuser design provide high luminous efficiency and comfortable vision in all kinds of areas. It offers easy installation and maintenance opportunities.



LED ELIPS ETANJ ARMATÜR

LED ELIPS WATERPROOF ARMATURE

Ürün Kodu Product Code	Güç (W) Power	Renk Sıcaklığı (K) Color Temperature	Işık Akısı (Lm) Luminous Flux	Boyutlar (WxLxH) mm Dimensions	Opsiyonlar Options	Koli Adeti Quantity in Carton	Fiyat Price
BL-E1-0010	20W	4000 K	1800	75 × 600 × 75	-	12	\$19,20
BL-E1-0010-1H	20W	4000 K	1800	75 × 600 × 75	1 Saat Acil Kit	12	\$63,10
BL-E1-0010-3H	20W	4000 K	1800	75 × 600 × 75	3 Saat Acil Kit	12	\$76,10
BL-E1-0010-RS	20W	4000 K	1800	75 × 600 × 75	Radar Sensörlü	12	\$28,80
BL-E1-0010-RS-1H	20W	4000 K	1800	75 × 600 × 75	Radar Sensörlü 1 Saat Acil Kit	12	\$65,90
BL-E1-0010-RS-3H	20W	4000 K	1800	75 × 600 × 75	Radar Sensörlü 3 Saat Acil Kit	12	\$78,90
BL-E1-0014	20W	6500 K	1800	75 × 600 × 75	-	12	\$19,20
BL-E1-0014-1H	20W	6500 K	1800	75 × 600 × 75	1 Saat Acil Kit	12	\$63,10
BL-E1-0014-3H	20W	6500 K	1800	75 × 600 × 75	3 Saat Acil Kit	12	\$76,10
BL-E1-0014-RS	20W	6500 K	1800	75 × 600 × 75	Radar Sensörlü	12	\$28,80
BL-E1-0014-RS-1H	20W	6500 K	1800	75 × 600 × 75	Radar Sensörlü 1 Saat Acil Kit	12	\$65,90
BL-E1-0014-RS-3H	20W	6500 K	1800	75 × 600 × 75	Radar Sensörlü 3 Saat Acil Kit	12	\$78,90
BL-E1-0012	40W	4000 K	3600	75 × 1200 × 75	-	12	\$33,60
BL-E1-0012-1H	40W	4000 K	3600	75 × 1200 × 75	1 Saat Acil Kit	12	\$76,60
BL-E1-0012-3H	40W	4000 K	3600	75 × 1200 × 75	3 Saat Acil Kit	12	\$90,50
BL-E1-0012-RS	40W	4000 K	3600	75 × 1200 × 75	Radar Sensörlü	12	\$53,55
BL-E1-0012-RS-1H	40W	4000 K	3600	75 × 1200 × 75	Radar Sensörlü 1 Saat Acil Kit	12	\$79,50
BL-E1-0012-RS-3H	40W	4000 K	3600	75 × 1200 × 75	Radar Sensörlü 3 Saat Acil Kit	12	\$93,35
BL-E1-0016	40W	6500 K	3600	75 × 1200 × 75	-	12	\$33,60
BL-E1-0016-1H	40W	6500 K	3600	75 × 1200 × 75	1 Saat Acil Kit	12	\$76,60
BL-E1-0016-3H	40W	6500 K	3600	75 × 1200 × 75	3 Saat Acil Kit	12	\$90,50
BL-E1-0016-RS	40W	6500 K	3600	75 × 1200 × 75	Radar Sensörlü	12	\$53,55
BL-E1-0016-RS-1H	40W	6500 K	3600	75 × 1200 × 75	Radar Sensörlü 1 Saat Acil Kit	12	\$79,50
BL-E1-0016-RS-3H	40W	6500 K	3600	75 × 1200 × 75	Radar Sensörlü 3 Saat Acil Kit	12	\$93,35

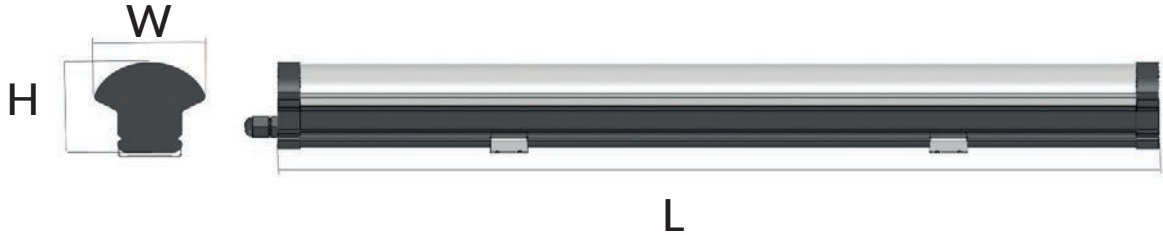

Teknik veri / Datasheet

LED ELIPS ETANJ ARMATÜR TSE

LED ELIPS WATERPROOF ARMATURE TSE

Teknik Özellikler Technical Specifications

Gövde : Polikarbonat
Body : Polycarbonate

Gövde Renkleri : Gri
Body Colors : Grey

Kapak : Polikarbonat
Cover : Polycarbonate

Kapak Rengi : Gri
Cover Color : Grey

Renksel Geri Verim : 80
Color Rendering Index : 80

IP Derecesi : IP65
IP Rating : IP65

IK Derecesi : IK09
IK Rating : IK09

Elektriksel Koruma : Sınıf II
Electrical Protection : Class II

Çalışma Sıcaklığı : -20°C / 45°C
Operating Temp. Range : -20°C / 45°C

3000 K OPSİYONDUR
L : 1500 MM OPSİYONU VARDIR

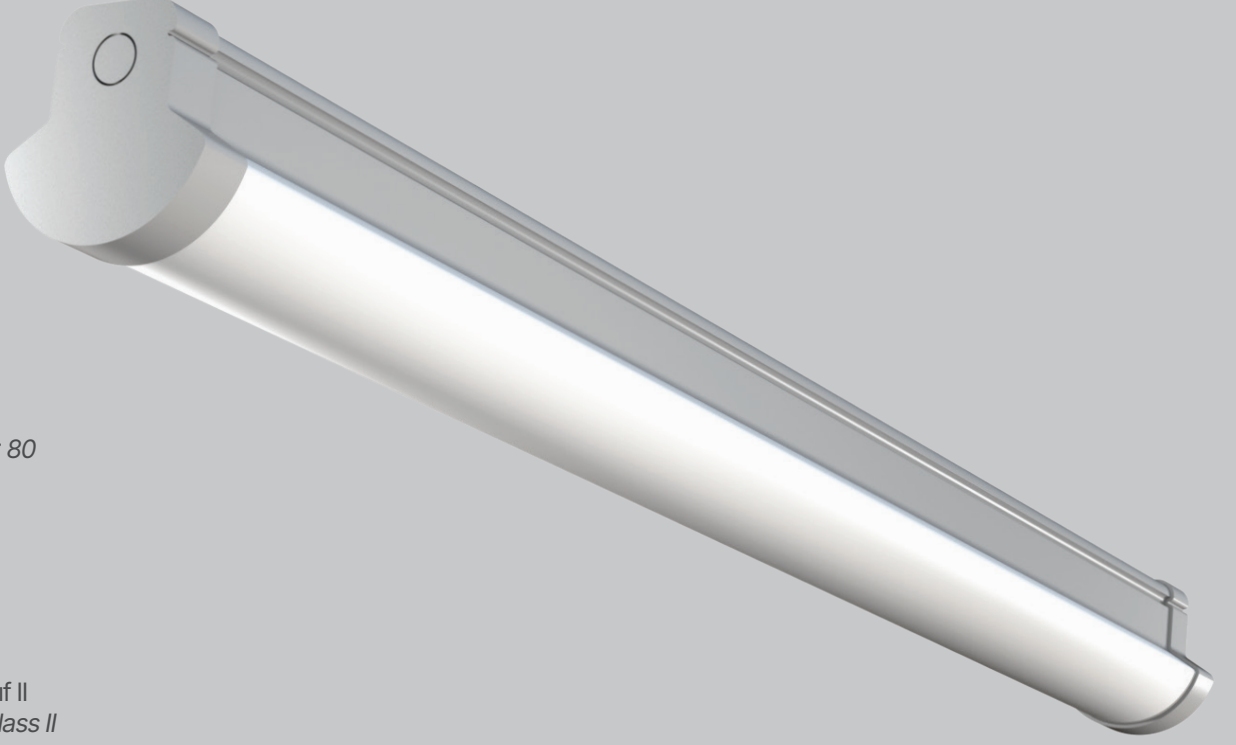

LED

3
YIL
GARANTİ

50.000
SAAT

IP65



LED ELIPS ETANJ ARMATÜR TSE

IP65 koruma standartlarında polikarbon gövde ve difüzör yapısı; neme, toza, doğrudan su ve darbelere karşı etkindir. Led aydınlatma ve difüzör tasarımı, her türlü alanda yüksek ışık verimliliği ve konforlu görüş sağlar. Kolay montaj ve bakım imkanları sunar.

LED ELIPS WATERPROOF ARMATURE TSE

Polycarbonate body and diffuser structure in IP65 protection standards; It is effective against moisture, dust, direct water and impacts. Led lighting and diffuser design provide high luminous efficiency and comfortable vision in all kinds of areas. It offers easy installation and maintenance opportunities.



LED ELIPS ETANJ ARMATÜR TSE

LED ELIPS WATERPROOF ARMATURE TSE

Ürün Kodu Product Code	Güç (W) Power	Renk Sıcaklığı (K) Color Temperature	Işık Akısı (Lm) Luminous Flux	Boyutlar (WxLxH) mm Dimensions	Opsiyonlar Options	Koli Adeti Quantity in Carton	Fiyat Price
BLT-E1-0010	20W	4000 K	2000	75 × 600 × 75	-	12	\$38,70
BLT-E1-0010-1H	20W	4000 K	2000	75 × 600 × 75	1 Saat Acil Kit	12	\$87,00
BLT-E1-0010-3H	20W	4000 K	2000	75 × 600 × 75	3 Saat Acil Kit	12	\$100,75
BLT-E1-0010-RS	20W	4000 K	2000	75 × 600 × 75	Radar Sensörlü	12	\$66,90
BLT-E1-0010-RS-1H	20W	4000 K	2000	75 × 600 × 75	Radar Sensörlü 1 Saat Acil Kit	12	\$114,50
BLT-E1-0010-RS-3H	20W	4000 K	2000	75 × 600 × 75	Radar Sensörlü 3 Saat Acil Kit	12	\$128,25
BLT-E1-0014	20W	6500 K	2000	75 × 600 × 75	-	12	\$38,70
BLT-E1-0014-1H	20W	6500 K	2000	75 × 600 × 75	1 Saat Acil Kit	12	\$87,00
BLT-E1-0014-3H	20W	6500 K	2000	75 × 600 × 75	3 Saat Acil Kit	12	\$100,75
BLT-E1-0014-RS	20W	6500 K	2000	75 × 600 × 75	Radar Sensörlü	12	\$66,90
BLT-E1-0014-RS-1H	20W	6500 K	2000	75 × 600 × 75	Radar Sensörlü 1 Saat Acil Kit	12	\$114,50
BLT-E1-0014-RS-3H	20W	6500 K	2000	75 × 600 × 75	Radar Sensörlü 3 Saat Acil Kit	12	\$128,25
BLT-E1-0012	40W	4000 K	4000	75 × 1200 × 75	-	12	\$54,45
BLT-E1-0012-1H	40W	4000 K	4000	75 × 1200 × 75	1 Saat Acil Kit	12	\$101,80
BLT-E1-0012-3H	40W	4000 K	4000	75 × 1200 × 75	3 Saat Acil Kit	12	\$116,55
BLT-E1-0012-RS	40W	4000 K	4000	75 × 1200 × 75	Radar Sensörlü	12	\$81,80
BLT-E1-0012-RS-1H	40W	4000 K	4000	75 × 1200 × 75	Radar Sensörlü 1 Saat Acil Kit	12	\$125,70
BLT-E1-0012-RS-3H	40W	4000 K	4000	75 × 1200 × 75	Radar Sensörlü 3 Saat Acil Kit	12	\$143,55
BLT-E1-0016	40W	6500 K	4000	75 × 1200 × 75	-	12	\$54,45
BLT-E1-0016-1H	40W	6500 K	4000	75 × 1200 × 75	1 Saat Acil Kit	12	\$101,80
BLT-E1-0016-3H	40W	6500 K	4000	75 × 1200 × 75	3 Saat Acil Kit	12	\$116,55
BLT-E1-0016-RS	40W	6500 K	4000	75 × 1200 × 75	Radar Sensörlü	12	\$81,80
BLT-E1-0016-RS-1H	40W	6500 K	4000	75 × 1200 × 75	Radar Sensörlü 1 Saat Acil Kit	12	\$125,70
BLT-E1-0016-RS-3H	40W	6500 K	4000	75 × 1200 × 75	Radar Sensörlü 3 Saat Acil Kit	12	\$143,55



Teknik veri / Datasheet



EX-PROOF LED ETANJ

EX-PROOF LED ETANJ

Teknik Özellikler

Technical Specifications

Gövde : Polikarbonat (PC)
Body : Polycarbonate

Gövde Renkleri : Turuncu
Body Colors : Orange

Difüzör : Polikarbonat (PC)
Diffuser : Polycarbonate

Renksel Geri Verim : 80
Color Rendering Index : 80

IP Derecesi : IP65
IP Rating : IP65

IK Derecesi : IK08
IK Rating : IK08

Elektriksel Koruma : Sınıf I
Electrical Protection : Class I

Çalışma Sıcaklığı : -20°C / 45°C
Operating Temp. Range : -20°C / 45°C

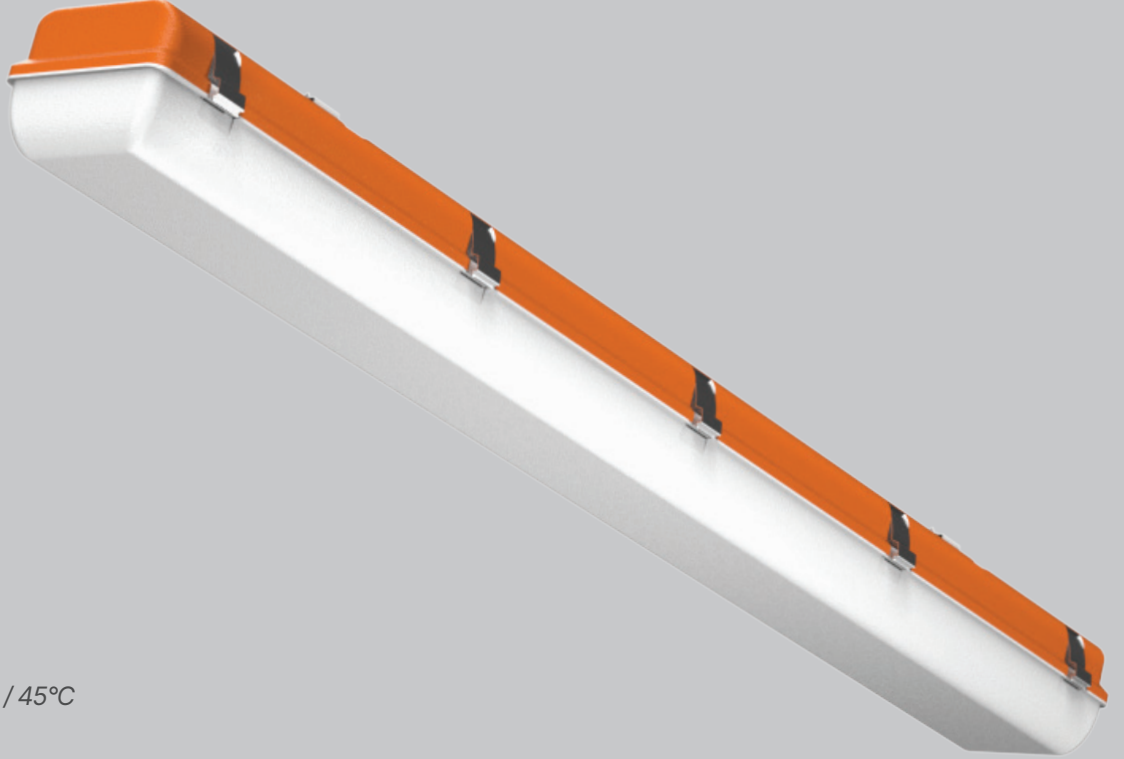

LED

3 YIL GARANTİ

50.000 SAAT

IP65



EX-PROOF LED ETANJ

Yüksek darbe dayanımlı polikarbonat gövde ve ideal tasarım elektrostatik toz boya ile sararma ve korozyona karşı dayanıklıdır. Polikarbon difüzör, optik homojen ışık yayılımı ve yüksek ışık geçirgenliği sağlar. Bu ürün kullanım yeri ve talep edilen normlara uygun ex-proof özelliklere sahiptir.

*Ex-proof Led Etanj Armatür, grup II tehlikeli açık ya da kapalı alanlarda kullanılmaktadır.

*Ex-proof kelimesi "Explosion-proof"un kısaltılmış halidir. Türkçede "patlamaya dayanıklı" olarak bilinmektedir.

Petrol ürün tesisleri, gaz istasyonları, rafineriler, kömür madenleri ve demir-çelik sanayi ayrıca şeker ve un fabrikaları gibi. Tehlikeli ve patlayıcı maddeler içeren çalışma ortamlarında patlamaları önlemek için güvenlik amaçlı kullanılan özel ürünlerdir.

EX-PROOF LED ETANJ

High impact polycarbonate body and ideal design electrostatic powder paint are resistant to yellowing and corrosion. The polycarbonate diffuser provides optical homogeneous light distribution and high light transmission. This product has ex-proof features by the place of use and the requested norms.

*Ex-proof Led lighting fixtures are used in Group II hazardous areas at indoor or outdoor services.

*The word exproof is the abbreviation of "Explosion-proof". It is known as "explosion-proof" in Turkish.

These are specific products used for safety purposes to prevent explosions in working environments containing hazardous and explosive substances. Such as oil product plants, gas stations, refineries, coal mines and iron and steel industries as well as sugar and flour mills.



EX-PROOF LED ETANJ

EX-PROOF LED ETANJ

Ürün Kodu Product Code	Güç (W) Power	Renk Sıcaklığı (K) Color Temperature	Işık Akısı (Lm) Luminous Flux	Boyutlar (WxLxH) mm Dimensions	Renk Color	Koli Adeti Quantity in Carton	Fiyat Price
BL-EX-0001	20W	3000 K	1800	95 × 670 × 125	Turuncu	1	Fiyat Sorunuz
BL-EX-0002	20W	3000 K	1800	95 × 670 × 125	Turuncu	1	Fiyat Sorunuz
BL-EX-0003	20W	3000 K	1800	95 × 670 × 125	Turuncu	1	Fiyat Sorunuz
BL-EX-0004	40W	4000 K	3600	95 × 1270 × 125	Turuncu	1	Fiyat Sorunuz
BL-EX-0005	40W	4000 K	3600	95 × 1270 × 125	Turuncu	1	Fiyat Sorunuz
BL-EX-0006	40W	4000 K	3600	95 × 1270 × 125	Turuncu	1	Fiyat Sorunuz
BL-EX-0007	60W	6500 K	5400	95 × 1270 × 125	Turuncu	1	Fiyat Sorunuz
BL-EX-0008	60W	6500 K	5400	95 × 1270 × 125	Turuncu	1	Fiyat Sorunuz
BL-EX-0009	60W	6500 K	5400	95 × 1270 × 125	Turuncu	1	Fiyat Sorunuz

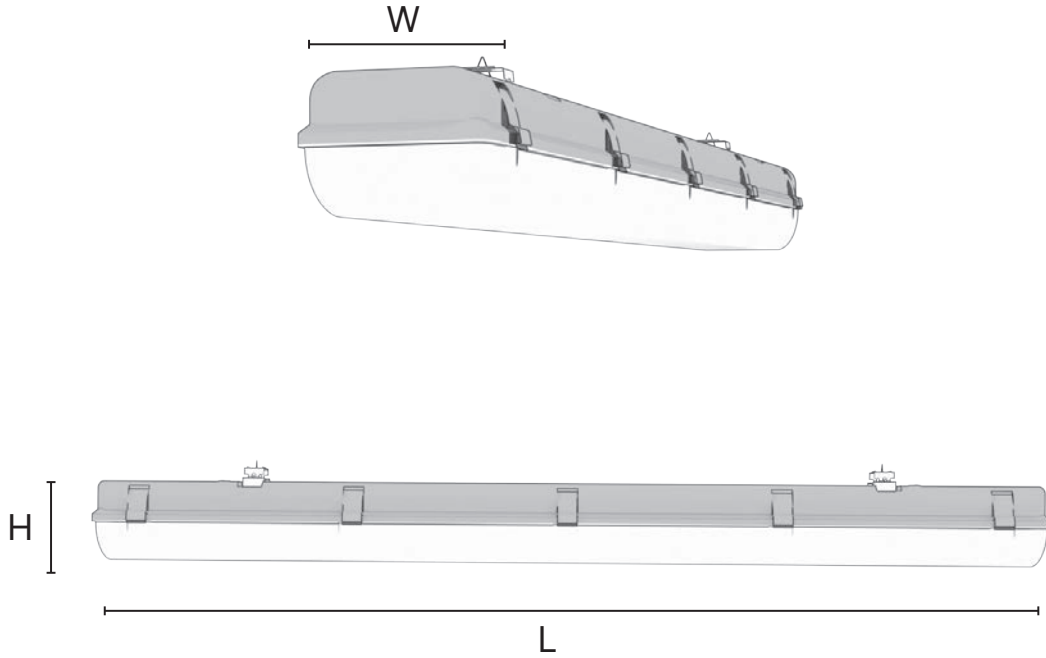

Teknik veri / Datasheet

T5 LED TUBE ARMATÜR

T5 LED TUBE ARMATURE

Teknik Özellikler

Technical Specifications

Gövde : Polikarbonat-TUBE
Body : Polycarbonate

Gövde Renkleri : Beyaz
Body Colors : White

Difüzör : Polikarbonat (PC)
Diffuser : Polycarbonate

Renksel Geri Verim : 80
Color Rendering Index : 80

IP Derecesi : IP20
IP Rating : IP20

IK Derecesi : IK02
IK Rating : IK02

Elektriksel Koruma : Sınıf I
Electrical Protection : Class I

Çalışma Sıcaklığı : -20°C / 45°C
Operating Temp. Range : -20°C / 45°C

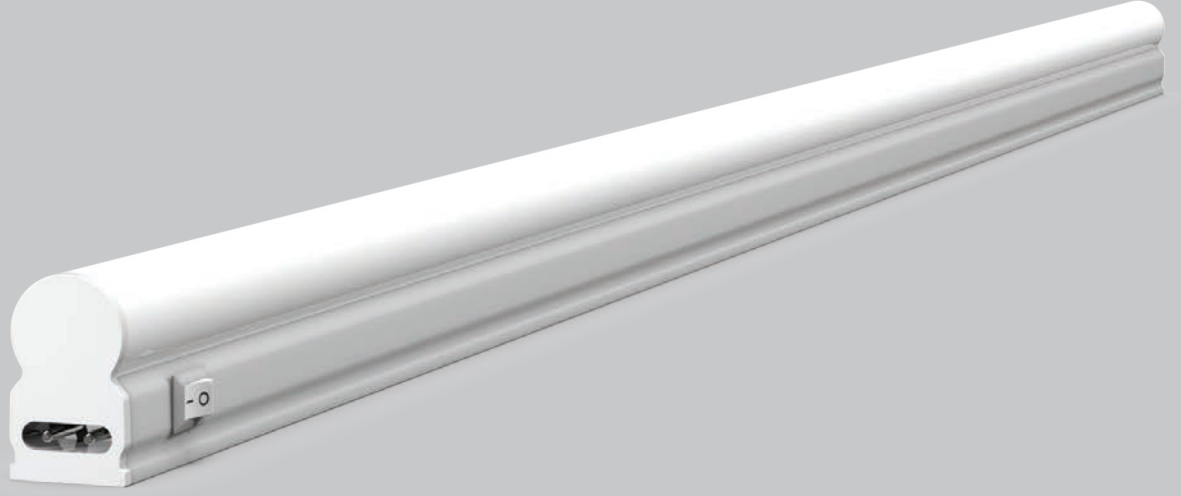

LED

1 YIL
GARANTİ

50.000
SAAT

T5 LED TUBE ARMATÜR

Sıcak ışık-nötr ışık-beyaz ışık seçenekleri sunan entegre sürücü ve led çiplerin verimli kullanımı ile sorunsuz ısı dağılımına ve uzun hizmet ömrüne sahiptir.

Ev, ofis, showrooamlar, alışveriş merkezleri, hastaneler ve oteller gibi iç mekan uygulamaları için tasarlanmış, mükemmel bir aydınlatma çözümdür.

T5 LED TUBE ARMATÜRE

It has problem-free heat dissipation and long service life with the efficient use of an integrated driver and led chips that offer warm light-neutral light-white light options. It is an excellent lighting solution designed for indoor applications such as homes, offices, showrooms, shopping malls, hospitals and hotels.



T5 LED TUBE ARMATÜR

T5 LED TUBE ARMATURE

Ürün Kodu Product Code	Güç (W) Power	Renk Sıcaklığı (K) Color Temperature	Işık Akısı (Lm) Luminous Flux	Boyutlar (WxLxH) mm Dimensions	Renk Color	Koli Adeti Quantity in Carton	Fiyat Price
BL-TB-0001	4W	6500 K	380	25 × 300 × 35	Beyaz	20	\$5,80
BL-TB-0002	4W	4000 K	380	25 × 300 × 35	Beyaz	20	\$5,80
BL-TB-0003	4W	3000 K	380	25 × 300 × 35	Beyaz	20	\$5,80
BL-TB-0004	8W	6500 K	760	25 × 600 × 35	Beyaz	20	\$7,05
BL-TB-0005	8W	4000 K	760	25 × 600 × 35	Beyaz	20	\$7,05
BL-TB-0006	8W	3000 K	760	25 × 600 × 35	Beyaz	20	\$7,05
BL-TB-0007	12W	6500 K	1150	25 × 900 × 35	Beyaz	20	\$8,50
BL-TB-0008	12W	4000 K	1150	25 × 900 × 35	Beyaz	20	\$8,50
BL-TB-0009	12W	3000 K	1150	25 × 900 × 35	Beyaz	20	\$8,50
BL-TB-0010	16W	6500 K	1500	25 × 1200 × 35	Beyaz	20	\$9,35
BL-TB-0011	16W	4000 K	1500	25 × 1200 × 35	Beyaz	20	\$9,35
BL-TB-0012	16W	3000 K	1500	25 × 1200 × 35	Beyaz	20	\$9,35

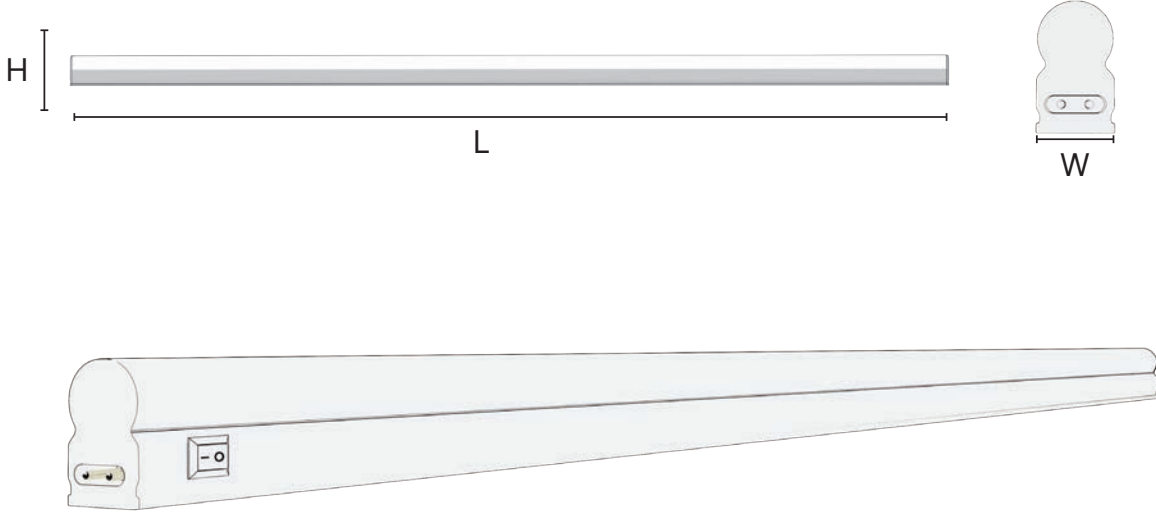

Teknik veri / Datasheet

AYNA ÜSTÜ ARMATÜR ABOVE MIRROR ARMATURE

Teknik Özellikler Technical Specifications

Gövde : Krom
Body : Chrome

Çalışma Gerilimi : 220-240 V AC
Operating Voltage : 220-240 V AC

Gövde Renkleri : Metalik
Body Colors : Metallic

Renksel Geri Verim : 80
Color Rendering Index : 80

IP Derecesi : IP20
IP Rating : IP20

Çalışma Sıcaklığı : -20 C / 45 C
Operating Temp. Range : -20 C / 45 C



24 W



12 W



AYNA ÜSTÜ ARMATÜR

Akrilik difüzör ve homojen led aydınlatma sağlayan mafsallı başlığıyla işlevsel. Paslanmaz krom kaplamalı gövdesi ile şık ve hijyenik bir aydınlatma armatürüdür.

ABOVE MIRROR ARMATURE

Functional with an acrylic diffuser and an articulated head that provides homogeneous LED lighting. It is a stylish and hygienic lighting fixture with its stainless chrome plated body.



AYNA ÜSTÜ ARMATÜR ABOVE MIRROR ARMATURE

Ürün Kodu Product Code	Güç (W) Power	Renk Sıcaklığı (K) Color Temperature	Işık Akısı (Lm) Luminous Flux	Boyutlar (WxLxH) mm Dimensions	Renk Color	Koli Adeti Quantity in Carton	Fiyat Price
BL-AU-0001	12W	3000 K	840	115 × 570 × 170	Metalik	15	\$54,10
BL-AU-0002	12W	4000 K	840	115 × 570 × 170	Metalik	15	\$54,10
BL-AU-0003	12W	6500 K	840	115 × 570 × 170	Metalik	15	\$54,10
BL-AU-1001	24W	3000 K	1680	90 × 570 × 220	Metalik	12	\$69,10
BL-AU-1002	24W	4000 K	1680	90 × 570 × 220	Metalik	12	\$69,10
BL-AU-1003	24W	6500 K	1680	90 × 570 × 220	Metalik	12	\$69,10

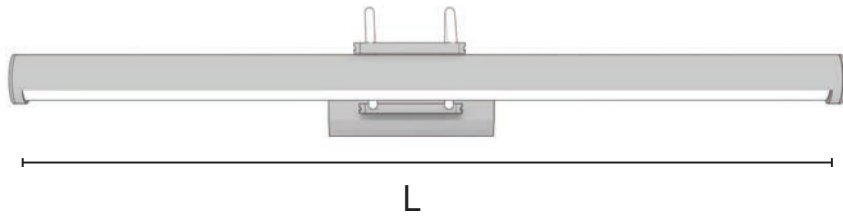
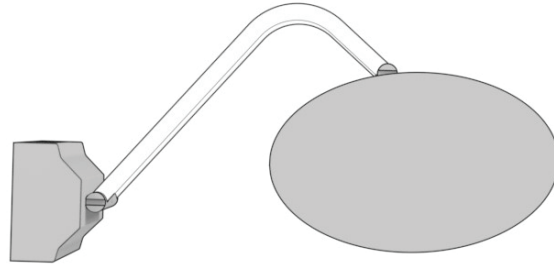
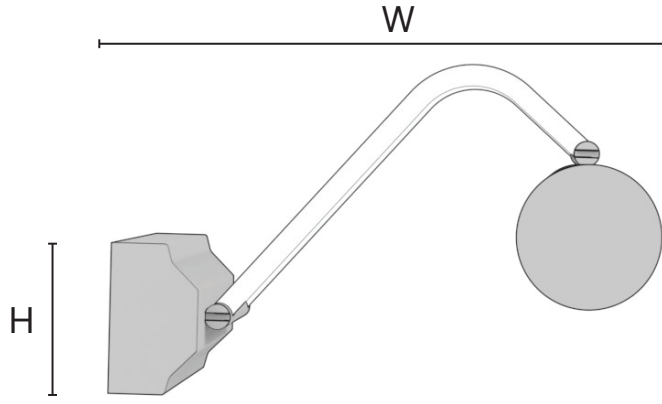

Teknik veri / Datasheet

OVAL LED GLOP ARMATÜR

OVAL LED GLOBE ARMATURE

Teknik Özellikler

Technical Specifications

Gövde : DKP Sac
Body : DKP Metal Sheet

Gövde Renkleri : Beyaz
Body Colors : White

Difüzör : Akrilik
Diffuser : Acrylic

Renksel Geri Verim : 80
Color Rendering Index : 80

IP Derecesi : IP20
IP Rating : IP20

IK Derecesi : IK03
IK Rating : IK03

Elektriksel Koruma : Sınıf I
Electrical Protection : Class I

Çalışma Sıcaklığı : -20°C / 45°C
Operating Temp. Range : -20°C / 45°C



LED

3
YIL
GARANTİ

50.000
SAAT



OVAL LED GLOP ARMATÜR

Bu armatürler fonksiyonel üst kapaklarından dolayı Glop adını almıştır. Glop ürünler yüzeysel bir aydınlatma yerine daha geniş, detaylı ve homojen aydınlatma sağlamaktadır.

OVAL LED GLOBE ARMATURE

These luminaires are named Glop because of their functional top covers. Glop products provide expanse, detailed and homogeneous lighting instead of superficial lighting.



OVAL LED GLOP ARMATÜR

OVAL LED GLOBE ARMATURE

Ürün Kodu Product Code	Güç (W) Power	Renk Sıcaklığı (K) Color Temperature	Işık Akısı (Lm) Luminous Flux	Boyutlar (ØxH) mm Dimensions	Opsiyonlar Options	Koli Adeti Quantity in Carton	Fiyat Price
BL-G1-0002	12W	3000 K	1080	260 × 83	-	24	\$21,50
BL-G1-0002-1H	12W	3000 K	1080	260 × 83	1 Saat Acil Kit	24	\$33,20
BL-G1-0002-3H	12W	3000 K	1080	260 × 83	3 Saat Acil Kit	24	\$40,75
BL-G1-0002-RS	12W	3000 K	1080	260 × 83	Radar Sensörlü	24	\$29,70
BL-G1-0002-RS-1H	12W	3000 K	1080	260 × 83	Radar Sensör & 1 Saat Acil Kit	24	\$42,60
BL-G1-0002-RS-3H	12W	3000 K	1080	260 × 83	Radar Sensör & 3 Saat Acil Kit	24	\$49,50
BL-G1-0014	12W	4000 K	1080	260 × 83	-	24	\$21,50
BL-G1-0014-1H	12W	4000 K	1080	260 × 83	1 Saat Acil Kit	24	\$33,20
BL-G1-0014-3H	12W	4000 K	1080	260 × 83	3 Saat Acil Kit	24	\$40,75
BL-G1-0014-RS	12W	4000 K	1080	260 × 83	Radar Sensörlü	24	\$29,70
BL-G1-0014-RS-1H	12W	4000 K	1080	260 × 83	Radar Sensör & 1 Saat Acil Kit	24	\$42,60
BL-G1-0014-RS-3H	12W	4000 K	1080	260 × 83	Radar Sensör & 3 Saat Acil Kit	24	\$49,50
BL-G1-0008	12W	6500 K	1080	260 × 83	-	24	\$21,50
BL-G1-0008-1H	12W	6500 K	1080	260 × 83	1 Saat Acil Kit	24	\$33,20
BL-G1-0008-3H	12W	6500 K	1080	260 × 83	3 Saat Acil Kit	24	\$40,75
BL-G1-0008-RS	12W	6500 K	1080	260 × 83	Radar Sensörlü	24	\$29,70
BL-G1-0008-RS-1H	12W	6500 K	1080	260 × 83	Radar Sensör & 1 Saat Acil Kit	24	\$42,60
BL-G1-0008-RS-3H	12W	6500 K	1080	260 × 83	Radar Sensör & 3 Saat Acil Kit	24	\$49,50
BL-G1-0004	18W	3000 K	1620	330 × 96	-	12	\$27,60
BL-G1-0004-1H	18W	3000 K	1620	330 × 96	1 Saat Acil Kit	12	\$38,30
BL-G1-0004-3H	18W	3000 K	1620	330 × 96	3 Saat Acil Kit	12	\$45,90
BL-G1-0004-RS	18W	3000 K	1620	330 × 96	Radar Sensörlü	12	\$34,85
BL-G1-0004-RS-1H	18W	3000 K	1620	330 × 96	Radar Sensör & 1 Saat Acil Kit	12	\$47,70
BL-G1-0004-RS-3H	18W	3000 K	1620	330 × 96	Radar Sensör & 3 Saat Acil Kit	12	\$55,45
BL-G1-0016	18W	4000 K	1620	330 × 96	-	12	\$27,60
BL-G1-0016-1H	18W	4000 K	1620	330 × 96	1 Saat Acil Kit	12	\$38,30
BL-G1-0016-3H	18W	4000 K	1620	330 × 96	3 Saat Acil Kit	12	\$45,90



Teknik veri / Datasheet

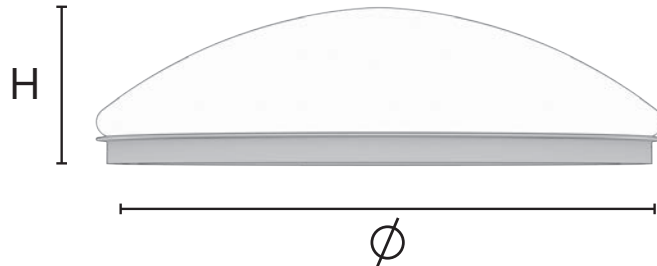

OVAL LED GLOP ARMATÜR

OVAL LED GLOBE ARMATURE

Teknik Özellikler

Technical Specifications

Gövde : DKP Sac
Body : DKP Metal Sheet

Gövde Renkleri : Beyaz
Body Colors : White

Difüzör : Akrilik
Diffuser : Acrylic

Renksel Geri Verim : 80
Color Rendering Index : 80

IP Derecesi : IP20
IP Rating : IP20

IK Derecesi : IK03
IK Rating : IK03

Elektriksel Koruma : Sınıf I
Electrical Protection : Class I

Çalışma Sıcaklığı : -20°C / 45°C
Operating Temp. Range : -20°C / 45°C



LED

3
YIL
GARANTİ

50.000
SAAT



OVAL LED GLOP ARMATÜR

Bu armatürler fonksiyonel üst kapaklarından dolayı Glop adını almıştır. Glop ürünler yüzeysel bir aydınlatma yerine daha geniş, detaylı ve homojen aydınlatma sağlamaktadır.

OVAL LED GLOBE ARMATURE

These luminaires are named Glop because of their functional top covers. Glop products provide expanse, detailed and homogeneous lighting instead of superficial lighting.



OVAL LED GLOP ARMATÜR

OVAL LED GLOBE ARMATURE

Ürün Kodu Product Code	Güç (W) Power	Renk Sıcaklığı (K) Color Temperature	Işık Akısı (Lm) Luminous Flux	Boyutlar (ØxH) mm Dimensions	Opsiyonlar Options	Koli Adeti Quantity in Carton	Fiyat Price
BL-G1-0016-RS	18W	4000 K	1620	330 × 96	Radar Sensörlü	12	\$34,85
BL-G1-0016-RS-1H	18W	4000 K	1620	330 × 96	Radar Sensör & 1 Saat Acil Kit	12	\$47,70
BL-G1-0016-RS-3H	18W	4000 K	1620	330 × 96	Radar Sensör & 3 Saat Acil Kit	12	\$55,45
BL-G1-0010	18W	6500 K	1620	330 × 96	-	12	\$27,60
BL-G1-0010-1H	18W	6500 K	1620	330 × 96	1 Saat Acil Kit	12	\$38,30
BL-G1-0010-3H	18W	6500 K	1620	330 × 96	3 Saat Acil Kit	12	\$45,90
BL-G1-0010-RS	18W	6500 K	1620	330 × 96	Radar Sensörlü	12	\$34,85
BL-G1-0010-RS-1H	18W	6500 K	1620	330 × 96	Radar Sensör & 1 Saat Acil Kit	12	\$47,70
BL-G1-0010-RS-3H	18W	6500 K	1620	330 × 96	Radar Sensör & 3 Saat Acil Kit	12	\$55,45
BL-G1-0006	24W	3000 K	2160	380 × 100	-	6	\$33,00
BL-G1-0006-1H	24W	3000 K	2160	380 × 100	1 Saat Acil Kit	6	\$44,85
BL-G1-0006-3H	24W	3000 K	2160	380 × 100	3 Saat Acil Kit	6	\$51,60
BL-G1-0006-RS	24W	3000 K	2160	380 × 100	Radar Sensörlü	6	\$40,75
BL-G1-0006-RS-1H	24W	3000 K	2160	380 × 100	Radar Sensör & 1 Saat Acil Kit	6	\$53,45
BL-G1-0006-RS-3H	24W	3000 K	2160	380 × 100	Radar Sensör & 3 Saat Acil Kit	6	\$61,15
BL-G1-0018	24W	4000 K	2160	380 × 100	-	6	\$33,00
BL-G1-0018-1H	24W	4000 K	2160	380 × 100	1 Saat Acil Kit	6	\$44,85
BL-G1-0018-3H	24W	4000 K	2160	380 × 100	3 Saat Acil Kit	6	\$51,60
BL-G1-0018-RS	24W	4000 K	2160	380 × 100	Radar Sensörlü	6	\$40,75
BL-G1-0018-RS-1H	24W	4000 K	2160	380 × 100	Radar Sensör & 1 Saat Acil Kit	6	\$53,45
BL-G1-0018-RS-3H	24W	4000 K	2160	380 × 100	Radar Sensör & 3 Saat Acil Kit	6	\$61,15
BL-G1-0012	24W	6500 K	2160	380 × 100	-	6	\$33,00
BL-G1-0012-1H	24W	6500 K	2160	380 × 100	1 Saat Acil Kit	6	\$44,85
BL-G1-0012-3H	24W	6500 K	2160	380 × 100	3 Saat Acil Kit	6	\$51,60
BL-G1-0012-RS	24W	6500 K	2160	380 × 100	Radar Sensörlü	6	\$40,75
BL-G1-0012-RS-1H	24W	6500 K	2160	380 × 100	Radar Sensör & 1 Saat Acil Kit	6	\$53,45
BL-G1-0012-RS-3H	24W	6500 K	2160	380 × 100	Radar Sensör & 3 Saat Acil Kit	6	\$61,15



Teknik veri / Datasheet

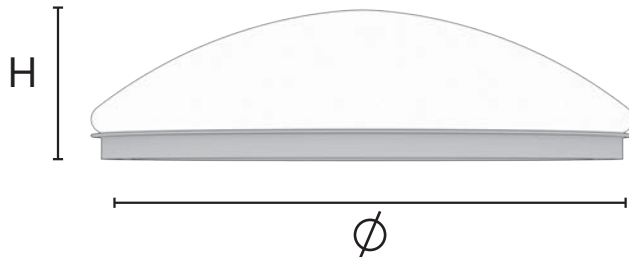

FLAT LED GLOP ARMATÜR

FLAT LED GLOBE ARMATURE

Teknik Özellikler

Technical Specifications

Gövde : DKP Sac
Body : DKP Metal Sheet

Gövde Renkleri : Beyaz
Body Colors : White

Difüzör : Akrilik
Diffuser : Acrylic

Renksel Geri Verim : 80
Color Rendering Index : 80

IP Derecesi : IP20
IP Rating : IP20

IK Derecesi : IK03
IK Rating : IK03

Elektriksel Koruma : Sınıf I
Electrical Protection : Class I

Çalışma Sıcaklığı : -20°C / 45°C
Operating Temp. Range : -20°C / 45°C



FLAT LED GLOP ARMATÜR

Bu armatürler fonksiyonel üst kapaklarından dolayı Glop adını almıştır. Glop ürünler yüzeysel bir aydınlatma yerine daha geniş, detaylı ve homojen aydınlatma sağlamaktadır.

FLAT LED GLOBE ARMATURE

These luminaires are named Glop because of their functional top covers. Glop products provide expanse, detailed and homogeneous lighting instead of superficial lighting.



FLAT LED GLOP ARMATÜR

FLAT LED GLOBE ARMATURE

Ürün Kodu Product Code	Güç (W) Power	Renk Sıcaklığı (K) Color Temperature	Işık Akısı (Lm) Luminous Flux	Boyutlar (ØxH) mm Dimensions	Opsiyonlar Options	Koli Adeti Quantity in Carton	Fiyat Price
BL-G1-0001	12W	3000 K	1080	260 × 83	-	24	\$21,50
BL-G1-0001-1H	12W	3000 K	1080	260 × 83	1 Saat Acil Kit	24	\$33,20
BL-G1-0001-3H	12W	3000 K	1080	260 × 83	3 Saat Acil Kit	24	\$40,75
BL-G1-0001-RS	12W	3000 K	1080	260 × 83	Radar Sensörlü	24	\$29,70
BL-G1-0001-RS-1H	12W	3000 K	1080	260 × 83	Radar Sensörlü 1 Saat Acil Kit	24	\$42,60
BL-G1-0001-RS-3H	12W	3000 K	1080	260 × 83	Radar Sensörlü 3 Saat Acil Kit	24	\$49,50
BL-G1-0013	12W	4000 K	1080	260 × 83	-	24	\$21,50
BL-G1-0013-1H	12W	4000 K	1080	260 × 83	1 Saat Acil Kit	24	\$33,20
BL-G1-0013-3H	12W	4000 K	1080	260 × 83	3 Saat Acil Kit	24	\$40,75
BL-G1-0013-RS	12W	4000 K	1080	260 × 83	Radar Sensörlü	24	\$29,70
BL-G1-0013-RS-1H	12W	4000 K	1080	260 × 83	Radar Sensörlü 1 Saat Acil Kit	24	\$42,60
BL-G1-0013-RS-3H	12W	4000 K	1080	260 × 83	Radar Sensörlü 3 Saat Acil Kit	24	\$49,50
BL-G1-0007	12W	6500 K	1080	260 × 83	-	24	\$21,50
BL-G1-0007-1H	12W	6500 K	1080	260 × 83	1 Saat Acil Kit	24	\$33,20
BL-G1-0007-3H	12W	6500 K	1080	260 × 83	3 Saat Acil Kit	24	\$40,75
BL-G1-0007-RS	12W	6500 K	1080	260 × 83	Radar Sensörlü	24	\$29,70
BL-G1-0007-RS-1H	12W	6500 K	1080	260 × 83	Radar Sensörlü 1 Saat Acil Kit	24	\$42,60
BL-G1-0007-RS-3H	12W	6500 K	1080	260 × 83	Radar Sensörlü 3 Saat Acil Kit	24	\$49,50
BL-G1-0003	18W	3000 K	1620	330 × 96	-	12	\$27,60
BL-G1-0003-1H	18W	3000 K	1620	330 × 96	1 Saat Acil Kit	12	\$38,30
BL-G1-0003-3H	18W	3000 K	1620	330 × 96	3 Saat Acil Kit	12	\$45,90
BL-G1-0003-RS	18W	3000 K	1620	330 × 96	Radar Sensörlü	12	\$34,85
BL-G1-0003-RS-1H	18W	3000 K	1620	330 × 96	Radar Sensörlü 1 Saat Acil Kit	12	\$47,70
BL-G1-0003-RS-3H	18W	3000 K	1620	330 × 96	Radar Sensörlü 3 Saat Acil Kit	12	\$55,45
BL-G1-0015	18W	4000 K	1620	330 × 96	-	12	\$27,60
BL-G1-0015-1H	18W	4000 K	1620	330 × 96	1 Saat Acil Kit	12	\$38,30
BL-G1-0015-3H	18W	4000 K	1620	330 × 96	3 Saat Acil Kit	12	\$45,90



Teknik veri / Datasheet

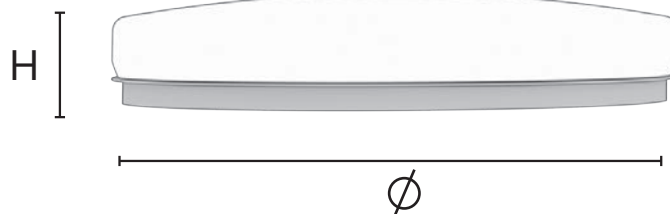

FLAT LED GLOP ARMATÜR

FLAT LED GLOBE ARMATURE

Teknik Özellikler

Technical Specifications

Gövde : DKP Sac
Body : DKP Metal Sheet

Gövde Renkleri : Beyaz
Body Colors : White

Difüzör : Akrilik
Diffuser : Acrylic

Renksel Geri Verim : 80
Color Rendering Index : 80

IP Derecesi : IP20
IP Rating : IP20

IK Derecesi : IK03
IK Rating : IK03

Elektriksel Koruma : Sınıf I
Electrical Protection : Class I

Çalışma Sıcaklığı : -20°C / 45°C
Operating Temp. Range : -20°C / 45°C



FLAT LED GLOP ARMATÜR

Bu armatürler fonksiyonel üst kapaklarından dolayı Glop adını almıştır. Glop ürünler yüzeysel bir aydınlatma yerine daha geniş, detaylı ve homojen aydınlatma sağlamaktadır.

FLAT LED GLOBE ARMATURE

These luminaires are named Glop because of their functional top covers. Glop products provide expanse, detailed and homogeneous lighting instead of superficial lighting.



FLAT LED GLOP ARMATÜR

FLAT LED GLOBE ARMATURE

Ürün Kodu Product Code	Güç (W) Power	Renk Sıcaklığı (K) Color Temperature	Işık Akısı (Lm) Luminous Flux	Boyutlar (ØxH) mm Dimensions	Opsiyonlar Options	Koli Adeti Quantity in Carton	Fiyat Price
BL-G1-0015-RS	18W	4000 K	1620	330 x 96	Radar Sensörlü	12	\$34,85
BL-G1-0015-RS-1H	18W	4000 K	1620	330 x 96	Radar Sensörlü 1 Saat Acil Kit	12	\$47,70
BL-G1-0015-RS-3H	18W	4000 K	1620	330 x 96	Radar Sensörlü 3 Saat Acil Kit	12	\$55,45
BL-G1-0009	18W	6500 K	1620	330 x 96	-	12	\$27,60
BL-G1-0009-1H	18W	6500 K	1620	330 x 96	1 Saat Acil Kit	12	\$38,30
BL-G1-0009-3H	18W	6500 K	1620	330 x 96	3 Saat Acil Kit	12	\$45,90
BL-G1-0009-RS	18W	6500 K	1620	330 x 96	Radar Sensörlü	12	\$34,85
BL-G1-0009-RS-1H	18W	6500 K	1620	330 x 96	Radar Sensörlü 1 Saat Acil Kit	12	\$47,70
BL-G1-0009-RS-3H	18W	6500 K	1620	330 x 96	Radar Sensörlü 3 Saat Acil Kit	12	\$55,45
BL-G1-0005	24W	3000 K	2160	380 x 100	-	6	\$33,00
BL-G1-0005-1H	24W	3000 K	2160	380 x 100	1 Saat Acil Kit	6	\$44,85
BL-G1-0005-3H	24W	3000 K	2160	380 x 100	3 Saat Acil Kit	6	\$51,60
BL-G1-0005-RS	24W	3000 K	2160	380 x 100	Radar Sensörlü	6	\$40,75
BL-G1-0005-RS-1H	24W	3000 K	2160	380 x 100	Radar Sensörlü 1 Saat Acil Kit	6	\$53,45
BL-G1-0005-RS-3H	24W	3000 K	2160	380 x 100	Radar Sensörlü 3 Saat Acil Kit	6	\$61,15
BL-G1-0017	24W	4000 K	2160	380 x 100	-	6	\$33,00
BL-G1-0017-1H	24W	4000 K	2160	380 x 100	1 Saat Acil Kit	6	\$44,85
BL-G1-0017-3H	24W	4000 K	2160	380 x 100	3 Saat Acil Kit	6	\$51,60
BL-G1-0017-RS	24W	4000 K	2160	380 x 100	Radar Sensörlü	6	\$40,75
BL-G1-0017-RS-1H	24W	4000 K	2160	380 x 100	Radar Sensörlü 1 Saat Acil Kit	6	\$53,45
BL-G1-0017-RS-3H	24W	4000 K	2160	380 x 100	Radar Sensörlü 3 Saat Acil Kit	6	\$61,15
BL-G1-0011	24W	6500 K	2160	380 x 100	-	6	\$33,00
BL-G1-0011-1H	24W	6500 K	2160	380 x 100	1 Saat Acil Kit	6	\$44,85
BL-G1-0011-3H	24W	6500 K	2160	380 x 100	3 Saat Acil Kit	6	\$51,60
BL-G1-0011-RS	24W	6500 K	2160	380 x 100	Radar Sensörlü	6	\$40,75
BL-G1-0011-RS-1H	24W	6500 K	2160	380 x 100	Radar Sensörlü 1 Saat Acil Kit	6	\$53,45
BL-G1-0011-RS-3H	24W	6500 K	2160	380 x 100	Radar Sensörlü 3 Saat Acil Kit	6	\$61,15



Teknik veri / Datasheet

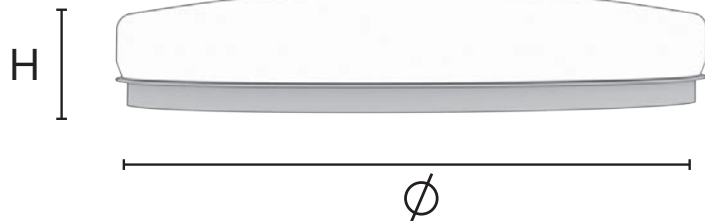

LED NEMLİYER YUVARLAK GLOP TAVAN ARMATÜR LED NEMLİYER ROUND GLOBE CEILING ARMATURE

Teknik Özellikler Technical Specifications

Gövde : Polikarbonat(PC)
Body : Polycarbonate

Difüzör : Akrilik
Diffuser : Acrylic

Renksel Geri Verim : 80
Color Rendering Index : 80

IP Derecesi : IP65
IP Rating : IP65

IK Derecesi : IK03
IK Rating : IK03

Elektriksel Koruma : Sınıf II
Electrical Protection : Class II

Çalışma Sıcaklığı : -20°C / 45°C
Operating Temp. Range : -20°C / 45°C



LED

3
YIL
GARANTİ

50.000
SAAT

IP65

LED NEMLİYER OVAL GLOP TAVAN ARMATÜR LED NEMLİYER OVAL GLOBE CEILING ARMATURE



LED NEMLİYER GLOP TAVAN ARMATÜR

Bu armatürler fonksiyonel üst kapaklarından dolayı Glop adını almıştır. Glop ürünler yüzeyel bir aydınlatma yerine daha geniş, detaylı ve homojen aydınlatma sağlamaktadır.

LED NEMLİYER GLOBE CEILING ARMATURE

These luminaires are named Glop because of their functional top covers. Glop products provide expanse, detailed and homogeneous lighting instead of superficial lighting.



LED NEMLİYER YUVARLAK GLOP TAVAN ARMATÜR

LED NEMLİYER ROUND GLOBE CEILING ARMATURE

Ürün Kodu Product Code	Güç (W) Power	Renk Sıcaklığı (K) Color Temperature	Işık Akısı (Lm) Luminous Flux	Boyutlar (ØxH) mm Dimensions	Renk Color	Koli Adeti Quantity in Carton	Fiyat Price
BL-G2-0002	12W	4000 K	1080	175 × 60	Beyaz White	24	\$17,40
BL-G2-0003	12W	6500 K	1080	175 × 60	Beyaz White	24	\$17,40
BL-G2-0005	15W	4000 K	1350	210 × 60	Beyaz White	12	\$23,30
BL-G2-0006	15W	6500 K	1350	210 × 60	Beyaz White	12	\$23,30
BL-G2-0008	12W	4000 K	1080	175 × 60	Siyah Black	24	\$17,40
BL-G2-0009	12W	6500 K	1080	175 × 60	Siyah Black	24	\$17,40
BL-G2-0011	15W	4000 K	1350	210 × 60	Siyah Black	12	\$23,30
BL-G2-0012	15W	6500 K	1350	210 × 60	Siyah Black	12	\$23,30

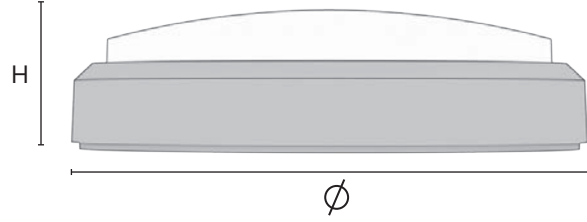

LED NEMLİYER OVAL GLOP TAVAN ARMATÜR

LED NEMLİYER OVAL GLOBE CEILING ARMATURE

Ürün Kodu Product Code	Güç (W) Power	Renk Sıcaklığı (K) Color Temperature	Işık Akısı (Lm) Luminous Flux	Boyutlar (WxLxH) mm Dimensions	Renk Color	Koli Adeti Quantity in Carton	Fiyat Price
BL-G3-0002	12W	4000 K	1080	100 × 200 × 60	Beyaz White	36	\$16,20
BL-G3-0003	12W	6500 K	1080	100 × 200 × 60	Beyaz White	36	\$16,20
BL-G3-0005	15W	4000 K	1350	105 × 230 × 60	Beyaz White	36	\$17,20
BL-G3-0006	15W	6500 K	1350	105 × 230 × 60	Beyaz White	36	\$17,20
BL-G3-0008	12W	4000 K	1080	100 × 200 × 60	Siyah Black	36	\$16,20
BL-G3-0009	12W	6500 K	1080	100 × 200 × 60	Siyah Black	36	\$16,20
BL-G3-0011	15W	4000 K	1350	105 × 230 × 60	Siyah Black	36	\$17,20
BL-G3-0012	15W	6500 K	1350	105 × 230 × 60	Siyah Black	36	\$17,20



Teknik veri / Datasheet

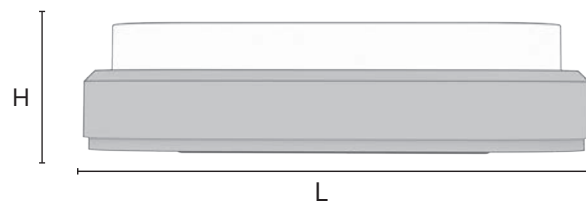

SENSÖRLÜ LED GLOP LED GLOBE WITH SENSOR

Teknik Özellikler Technical Specifications

Gövde : Polikarbonat (PC)
Body : Polycarbonate

Cam : Polikarbonat
Glass : Polycarbonate

Sensör Tipi : P.I.R Sensör
Sensor Type : P.I.R Sensor

Güç Faktörü : 0.5
Power Factor : 0.5

Renksel Geri Verim : 80
Color Rendering Index : 80



SENSÖRLÜ LED APLİK LED WALL LUMINAIRE WITH SENSOR



LED

3
YIL
GARANTİ

50.000
SAAT

IP54



SENSÖRLÜ GLOP LED

360 derece hareket kızıl ötesi elektronik sensörü ile her yönden algılama ve otomatik aydınlatma. Zaman ayarlı, estetik görünüm ve gözü yormayan soft aydınlatma, siva üstü kolay montaj.

SENSORED GLOP LED

360-degree motion detection and automatic illumination from all directions with an infrared electronic sensor. Timed, aesthetic appearance and soft lighting that does not tire the eyes, easy surface mounting.



SENSÖRLÜ LED GLOP

LED GLOBE WITH SENSOR

Ürün Kodu Product Code	Güç (W) Power	Renk Sıcaklığı (K) Color Temperature	Işık Akısı (Lm) Luminous Flux	Boyutlar (ØxH) mm Dimensions	Koli Adeti Quantity in Carton	Fiyat Price
BL-G4-0001-S	12W	3000 K	960	175 × 55	30	\$21,85
BL-G4-0002-S	12W	4000 K	960	175 × 55	30	\$21,85
BL-G4-0003-S	12W	6500 K	960	175 × 55	30	\$21,85
BL-G4-0004-S	15W	3000 K	1200	175 × 55	30	\$23,30
BL-G4-0005-S	15W	4000 K	1200	175 × 55	30	\$23,30
BL-G4-0006-S	15W	6500 K	1200	175 × 55	30	\$23,30

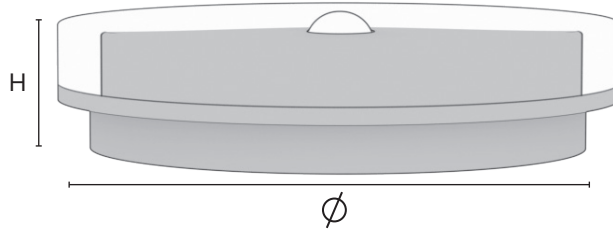

SENSÖRLÜ LED APLİK

LED WALL LUMINAIRE WITH SENSOR

Ürün Kodu Product Code	Güç (W) Power	Renk Sıcaklığı (K) Color Temperature	Işık Akısı (Lm) Luminous Flux	Boyutlar (WxLxH) mm Dimensions	Koli Adeti Quantity in Carton	Fiyat Price
BL-A1-0001-S	12W	3000 K	960	100 × 200 × 55	30	Fiyat Sorunuz
BL-A1-0002-S	12W	4000 K	960	100 × 200 × 55	30	Fiyat Sorunuz
BL-A1-0003-S	12W	6500 K	960	100 × 200 × 55	30	Fiyat Sorunuz
BL-A1-0004-S	15W	3000 K	1200	100 × 200 × 55	30	Fiyat Sorunuz
BL-A1-0005-S	15W	4000 K	1200	100 × 200 × 55	30	Fiyat Sorunuz
BL-A1-0006-S	15W	6500 K	1200	100 × 200 × 55	30	Fiyat Sorunuz



Teknik veri / Datasheet

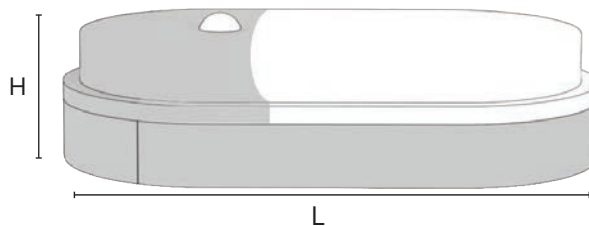

KARE LED TAVAN GLOP ARMATÜR
KARE LED CEILING GLOBE ARMATURE



UFO LED TAVAN GLOP ARMATÜR
UFO LED CEILING GLOBE ARMATURE



İNCİ LED TAVAN GLOP ARMATÜR
INCI LED CEILING GLOBE ARMATURE



OKYANUS LED TAVAN GLOP ARMATÜR
OKYANUS LED CEILING GLOBE ARMATURE



Gövde : DKP Sac
Body : DKP Metal Sheet

İSTANBUL LED TAVAN GLOP ARMATÜR
ISTANBUL LED CEILING GLOBE ARMATURE



ASOS LED TAVAN GLOP ARMATÜR
ASOS LED CEILING GLOBE ARMATURE



LED

3
YIL
GARANTİ

50.000
SAAT



Teknik Özellikler Technical Specifications

Gövde : ABS
Body : ABS

Cam : S.A.N.
Glass : S.A.N.

Renksel Geri Verim : 80
Color Rendering Index : 80

IP Derecesi : IP20
IP Rating : IP20

Sürücü : On-Board
Driver : On-Board

KARE LED TAVAN GLOP ARMATÜR KARE LED CEILING GLOBE ARMATURE

Ürün Kodu Product Code	Güç (W) Power	Renk Sıcaklığı (K) Color Temperature	Işık Akısı (Lm) Luminous Flux	Boyutlar (WxLxH)mm Dimensions	Kutu Adeti Quantity in Box	Koli Adeti Quantity in Carton	Fiyat Price
BL-B1-0007	12W	6500 K	960	250 × 250 × 93	2	24	\$18,20
BL-B1-0008	12W	3000 K	960	250 × 250 × 93	2	24	\$18,20

UFO LED TAVAN GLOP ARMATÜR UFO LED CEILING GLOBE ARMATURE

Ürün Kodu Product Code	Güç (W) Power	Renk Sıcaklığı (K) Color Temperature	Işık Akısı (Lm) Luminous Flux	Boyutlar (ØxH) mm Dimensions	Kutu Adeti Quantity in Box	Koli Adeti Quantity in Carton	Fiyat Price
BL-B1-0009	11W	6500 K	880	222 × 99	2	36	\$14,85
BL-B1-0010	11W	3000 K	880	222 × 99	2	36	\$14,85

İNCİ LED TAVAN GLOP ARMATÜR INCI LED CEILING GLOBE ARMATURE

Ürün Kodu Product Code	Güç (W) Power	Renk Sıcaklığı (K) Color Temperature	Işık Akısı (Lm) Luminous Flux	Boyutlar (ØxH) mm Dimensions	Kutu Adeti Quantity in Box	Koli Adeti Quantity in Carton	Fiyat Price
BL-B1-0011	11W	6500 K	880	290 × 90	2	16	\$20,30
BL-B1-0012	11W	3000 K	880	290 × 90	2	16	\$20,30

OKYANUS LED TAVAN GLOP ARMATÜR OKYANUS LED CEILING GLOBE ARMATURE

Ürün Kodu Product Code	Güç (W) Power	Renk Sıcaklığı (K) Color Temperature	Işık Akısı (Lm) Luminous Flux	Boyutlar (ØxH) mm Dimensions	Kutu Adeti Quantity in Box	Koli Adeti Quantity in Carton	Fiyat Price
BL-B1-0015	24W	6500 K	1560	345 × 50	2	12	\$21,95
BL-B1-0016	24W	3000 K	1560	345 × 50	2	12	\$21,95

İSTANBUL LED TAVAN GLOP ARMATÜR İSTANBUL LED CEILING GLOBE ARMATURE

Ürün Kodu Product Code	Güç (W) Power	Renk Sıcaklığı (K) Color Temperature	Işık Akısı (Lm) Luminous Flux	Boyutlar (WxLxH)mm Dimensions	Kutu Adeti Quantity in Box	Koli Adeti Quantity in Carton	Fiyat Price
BL-B1-0017	24W	6500 K	1920	315 × 275 × 90	2	12	\$23,00
BL-B1-0018	24W	3000 K	1920	315 × 275 × 90	2	12	\$23,00

ASOS LED TAVAN GLOP ARMATÜR ASOS LED CEILING GLOBE ARMATURE

Ürün Kodu Product Code	Güç (W) Power	Renk Sıcaklığı (K) Color Temperature	Işık Akısı (Lm) Luminous Flux	Boyutlar (WxLxH)mm Dimensions	Kutu Adeti Quantity in Box	Koli Adeti Quantity in Carton	Fiyat Price
BL-B1-0019	12W	6500 K	960	314 × 214 × 88	2	24	\$20,80
BL-B1-0020	12W	3000 K	960	314 × 214 × 88	2	24	\$20,80



Teknik veri / Datasheet

LED ZÜMRÜT SENSÖRLÜ TAVAN ARMATÜR
LED ZUMRUT CEILING ARMATURE
WITH MOTION SENSOR



LED ZÜMRÜT SENSÖRLÜ TAVAN ARMATÜR + ACIL KİT
LED ZUMRUT CEILING ARMATURE
WITH MOTION SENSOR + EMERGENCY KIT



ZÜMRÜT TAVAN ARMATÜR (2XE27 DUY)
ZUMRUT CEILING ARMATURE



ZÜMRÜT SENSÖRLÜ TAVAN ARMATÜR (2XE27 DUY)
ZUMRUT CEILING ARMATURE WITH MOTION SENSOR



ZÜMRÜT SENSÖRLÜ TAVAN ARMATÜR (2XE27 DUY) + ACIL KİT
ZUMRUT CEILING ARMATURE WITH MOTION SENSOR + EMERGENCY KIT



E27

LED



3
YIL
GARANTİ

Teknik Özellikler Technical Specifications

Gövde DKP Sac
Body : DKP Sheet Metal

IP Derecesi : IP20
IP Rating : IP20

Renksel Geri Verim : 80
Color Rendering Index : 80

Teknik Özellikler Technical Specifications

Gövde DKP Sac
Body : DKP Sheet Metal

IP Derecesi : IP20
IP Rating : IP20

Kullanım : Tasarruflu/
Led Ampul
Usage : Energy Saving/
Led Bulb



Teknik veri / Datasheet

LED ZÜMRÜT SENSÖRLÜ TAVAN ARMATÜR

LED ZUMRUT CEILING ARMATURE WITH MOTION SENSOR

Ürün Kodu Product Code	Güç (W) Power	Renk Sıcaklığı (K) Color Temperature	Işık Akısı (Lm) Luminous Flux	Boyutlar (WxLxH)mm Dimensions	Koli Adeti Quantity in Carton	Fiyat Price
BL-B1-0021	12W	6500 K	1300	285 × 100	10	\$23,00
BL-B1-0022	12W	4000 K	1300	285 × 100	10	\$23,00

LED ZÜMRÜT SENSÖRLÜ TAVAN ARMATÜR + ACIL KİT

LED ZUMRUT CEILING ARMATURE WITH MOTION SENSOR + EMERGENCY KIT

Ürün Kodu Product Code	Güç (W) Power	Renk Sıcaklığı (K) Color Temperature	Işık Akısı (Lm) Luminous Flux	Boyutlar (ØxH) mm Dimensions	Koli Adeti Quantity in Carton	Fiyat Price
BL-B1-0024	12W	6500 K	1300	285 × 100	10	\$32,80
BL-B1-0025	12W	4000 K	1300	285 × 100	10	\$32,80

ZÜMRÜT TAVAN ARMATÜR (2XE27 DUY)

ZUMRUT CEILING ARMATURE

Ürün Kodu Product Code	Renk Color	Boyutlar (ØxH) mm Dimensions	Kutu Adeti Quantity in Box	Koli Adeti Quantity in Carton	Fiyat Price
BR-00243-050	Beyaz	285 × 100	1	10	242,15 TL

ZÜMRÜT SENSÖRLÜ TAVAN ARMATÜR (2XE27 DUY)

ZUMRUT CEILING ARMATURE WITH MOTION SENSOR

Ürün Kodu Product Code	Renk Color	Boyutlar (ØxH) mm Dimensions	Kutu Adeti Quantity in Box	Koli Adeti Quantity in Carton	Fiyat Price
BR-10243 050	Beyaz	285 × 100	1	10	276,90 TL

ZÜMRÜT SENSÖRLÜ TAVAN ARMATÜR (2XE27 DUY) + ACIL KİT

ZUMRUT CEILING ARMATURE WITH MOTION SENSOR + EMERGENCY KIT

Ürün Kodu Product Code	Renk Color	Boyutlar (ØxH) mm Dimensions	Kutu Adeti Quantity in Box	Koli Adeti Quantity in Carton	Fiyat Price
BR-C0243-050	Beyaz	285 × 100	1	10	435,30 TL

UFO TAVAN ARMATÜR (1XE27 DUY)
UFO CEILING ARMATURE



UFOLINE TAVAN ARMATÜR (1XE27 DUY)
UFOLINE CEILING ARMATURE



UFOLÜX TAVAN ARMATÜR (1XE27 DUY)
UFOLUX CEILING ARMATURE



GÜNEŞ TAVAN ARMATÜR (1XE27 DUY)
GUNES CEILING ARMATURE



VEGA TAVAN ARMATÜR (1XE27 DUY)
VEGA CEILING ARMATURE



İSİS TAVAN ARMATÜR (1XE27 DUY)
ISIS CEILING ARMATURE



Teknik Özellikler Technical Specifications

Gövde ABS
Body : ABS

Cam : S.A.N
Glass : S.A.N

Gofraj : Alüminyum
Embossing : Aluminium

IP Derecesi : IP20
IP Rating : IP20

Kullanım : Tasarruflu/
Led Ampul

Usage : Energy Saving/
Led Bulb

UFO TAVAN ARMATÜR (1XE27 DUY) UFO CEILING ARMATURE

Ürün Kodu Product Code	Renk Color	Boyutlar (ØxH) mm Dimensions	Kutu Adeti Quantity in Box	Koli Adeti Quantity in Carton	Fiyat Price
BR-00203-000	Beyaz	222 × 99	2	36	64,60 TL

UFOLINE TAVAN ARMATÜR (1XE27 DUY) UFOLINE CEILING ARMATURE

Ürün Kodu Product Code	Renk Color	Boyutlar (ØxH) mm Dimensions	Kutu Adeti Quantity in Box	Koli Adeti Quantity in Carton	Fiyat Price
BR-00248-000	Beyaz	212 × 98	2	36	54,60 TL

UFOLÜX TAVAN ARMATÜR (1XE27 DUY) UFOLUX CEILING ARMATURE

Ürün Kodu Product Code	Renk Color	Boyutlar (ØxH) mm Dimensions	Kutu Adeti Quantity in Box	Koli Adeti Quantity in Carton	Fiyat Price
BR-00203-010	Beyaz	222 × 99	2	36	63,85 TL

GÜNEŞ TAVAN ARMATÜR (1XE27 DUY) GUNES CEILING ARMATURE

Ürün Kodu Product Code	Renk Color	Boyutlar (ØxH) mm Dimensions	Kutu Adeti Quantity in Box	Koli Adeti Quantity in Carton	Fiyat Price
BR-00203-020	Beyaz	222 × 99	2	36	65,90 TL

VEGA TAVAN ARMATÜR (1XE27 DUY) VEGA CEILING ARMATURE

Ürün Kodu Product Code	Renk Color	Boyutlar (ØxH) mm Dimensions	Kutu Adeti Quantity in Box	Koli Adeti Quantity in Carton	Fiyat Price
BR-00248-010	Beyaz	212 × 98	2	36	51,80 TL

İSİS TAVAN ARMATÜR (1XE27 DUY) ISIS CEILING ARMATURE

Ürün Kodu Product Code	Renk Color	Boyutlar (ØxH) mm Dimensions	Kutu Adeti Quantity in Box	Koli Adeti Quantity in Carton	Fiyat Price
BR-00244-000	Beyaz	214 × 314 × 88	2	24	93,10 TL



Teknik veri / Datasheet

ASOS TAVAN ARMATÜR (1XE27 DUY)
ASOS CEILING ARMATURE

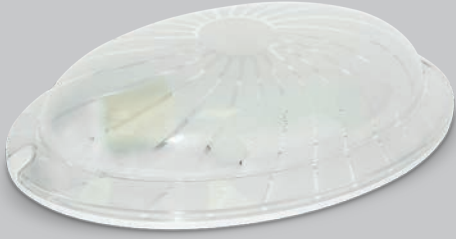

KARE TAVAN ARMATÜR (1XE27 DUY)
KARE CEILING ARMATURE



KARE SOFT TAVAN ARMATÜR (1XE27 DUY)
KARE SOFT CEILING ARMATURE



YASMIN TAVAN ARMATÜR (1XE27 DUY)
YASMIN CEILING ARMATURE



NEPTÜN TAVAN ARMATÜR (1XE27 DUY)
NEPTUN CEILING ARMATURE

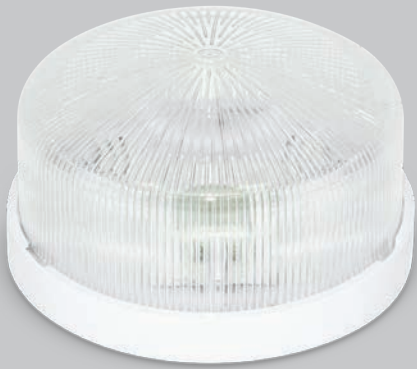

VENÜS TAVAN ARMATÜR (1XE27 DUY)
VENUS CEILING ARMATURE



Teknik Özellikler
Technical Specifications

Gövde ABS
Body : ABS

Cam : S.A.N
Glass : S.A.N

Gofraj : Alüminyum
Embossing : Aluminium

IP Derecesi : IP20
IP Rating : IP20

Kullanım : Tasarruflu/
Led Ampul
Usage : Energy Saving/
Led Bulb

ASOS TAVAN ARMATÜR (1XE27 DUY)

ASOS CEILING ARMATURE

Ürün Kodu Product Code	Renk Color	Boyutlar (WxLxH) mm Dimensions	Kutu Adeti Quantity in Box	Koli Adeti Quantity in Carton	Fiyat Price
BR-00244-010	Beyaz	214 × 314 × 88	2	24	88,60 TL

KARE TAVAN ARMATÜR (1XE27 DUY)

KARE CEILING ARMATURE

Ürün Kodu Product Code	Renk Color	Boyutlar (WxLxH) mm Dimensions	Kutu Adeti Quantity in Box	Koli Adeti Quantity in Carton	Fiyat Price
BR-00242-000	Beyaz	250 × 250 × 93	2	24	91,95 TL

KARE SOFT TAVAN ARMATÜR (1XE27 DUY)

KARE SOFT CEILING ARMATURE

Ürün Kodu Product Code	Renk Color	Boyutlar (WxLxH) mm Dimensions	Kutu Adeti Quantity in Box	Koli Adeti Quantity in Carton	Fiyat Price
BR-00242-010	Beyaz	250 × 250 × 93	2	24	92,30 TL

YASMIN TAVAN ARMATÜR (1XE27 DUY)

YASMIN CEILING ARMATURE

Ürün Kodu Product Code	Renk Color	Boyutlar (ØxH) mm Dimensions	Kutu Adeti Quantity in Box	Koli Adeti Quantity in Carton	Fiyat Price
BR-00245-000	Beyaz	220 × 125	2	36	82,30 TL

NEPTÜN TAVAN ARMATÜR (1XE27 DUY)

NEPTUN CEILING ARMATURE

Ürün Kodu Product Code	Renk Color	Boyutlar (ØxH) mm Dimensions	Kutu Adeti Quantity in Box	Koli Adeti Quantity in Carton	Fiyat Price
BR-00245-010	Beyaz	220 × 125	2	36	89,35 TL

VENÜS TAVAN ARMATÜR (1XE27 DUY)

VENUS CEILING ARMATURE

Ürün Kodu Product Code	Renk Color	Boyutlar (ØxH) mm Dimensions	Kutu Adeti Quantity in Box	Koli Adeti Quantity in Carton	Fiyat Price
BR-00201-000	Beyaz	240 × 100	2	36	95,90 TL



Teknik veri / Datasheet

UZAY TAVAN ARMATÜR (1XE27 DUY)
UZAY CEILING ARMATURE



İSTANBUL TAVAN ARMATÜR (2XE27 DUY)
İSTANBUL CEILING ARMATURE



BOSPHORUS TAVAN ARMATÜR (2XE27 DUY)
BOSPHORUS CEILING ARMATURE



GÖK SOFT TAVAN ARMATÜR (2XE27 DUY)
GOK SOFT CEILING ARMATURE

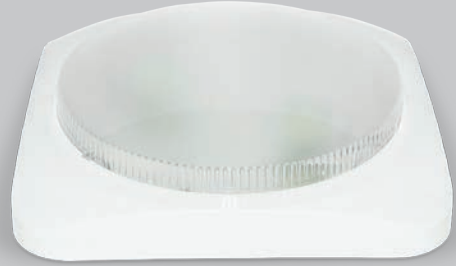

GÖK SIVA ÜSTÜ TAVAN ARMATÜR (2XE27 DUY)
GOK SURFACE MOUNTED CEILING ARMATURE



OKYANUS TAVAN ARMATÜR (2XE27 DUY)
OKYANUS CEILING ARMATURE



Teknik Özellikler Technical Specifications

Gövde ABS
Body : ABS

Cam : S.A.N
Glass : S.A.N

Gofraj : Alüminyum
Embossing : Aluminium

IP Derecesi : IP20
IP Rating : IP20

Kullanım : Tasarruflu/
Led Ampul
Usage : Energy Saving/
Led Bulb

UZAY TAVAN ARMATÜR (1XE27 DUY)

UZAY CEILING ARMATURE

Ürün Kodu Product Code	Renk Color	Boyutlar (ØxH) mm Dimensions	Kutu Adeti Quantity in Box	Koli Adeti Quantity in Carton	Fiyat Price
BR-00201-010	Beyaz	240 × 97	2	36	90,50 TL

İSTANBUL TAVAN ARMATÜR (2XE27 DUY)

İSTANBUL CEILING ARMATURE

Ürün Kodu Product Code	Renk Color	Boyutlar (WxLxH) mm Dimensions	Kutu Adeti Quantity in Box	Koli Adeti Quantity in Carton	Fiyat Price
BR-00247-000	Beyaz	315 × 275 × 90	2	12	119,95 TL

BOSPHORUS TAVAN ARMATÜR (2XE27 DUY)

BOSPHORUS CEILING ARMATURE

Ürün Kodu Product Code	Renk Color	Boyutlar (WxLxH) mm Dimensions	Kutu Adeti Quantity in Box	Koli Adeti Quantity in Carton	Fiyat Price
BR-00247-010	Beyaz	315 × 275 × 90	2	12	119,30 TL

GÖK SOFT TAVAN ARMATÜR (2XE27 DUY)

GOK SOFT CEILING ARMATURE

Ürün Kodu Product Code	Renk Color	Boyutlar (WxLxH) mm Dimensions	Kutu Adeti Quantity in Box	Koli Adeti Quantity in Carton	Fiyat Price
BR-00230-010	Beyaz	355 × 355 × 97	1	12	225,50 TL

GÖK SIVA ÜSTÜ TAVAN ARMATÜR (2XE27 DUY)

GOK SURFACE MOUNTED CEILING ARMATURE

Ürün Kodu Product Code	Renk Color	Boyutlar (WxLxH) mm Dimensions	Kutu Adeti Quantity in Box	Koli Adeti Quantity in Carton	Fiyat Price
BR-00230-000	Beyaz	355 × 355 × 97	1	12	220,40 TL

OKYANUS TAVAN ARMATÜR (2XE27 DUY)

OKYANUS CEILING ARMATURE

Ürün Kodu Product Code	Renk Color	Boyutlar (ØxH) mm Dimensions	Kutu Adeti Quantity in Box	Koli Adeti Quantity in Carton	Fiyat Price
BR-00231-000	Beyaz	345 × 105	2	12	128,10 TL



Teknik veri / Datasheet

OKYANUS SOFT TAVAN ARMATÜR (2XE27 DUY)
OKYANUS SOFT CEILING ARMATURE



ATLANTİK TAVAN GLOP ARMATÜR (2XE27 DUY)
ATLANTİK CEILING ARMATURE



İNCI TAVAN ARMATÜR (1XE27 DUY)
İNCI CEILING ARMATURE



YAKUT TAVAN ARMATÜR (1XE27 DUY)
YAKUT CEILING ARMATURE



Teknik Özellikler
Technical Specifications

Gövde ABS
Body : ABS

Cam : S.A.N
Glass : S.A.N

Gofraj : Alüminyum
Embossing : Aluminium

IP Derecesi : IP20
IP Rating : IP20

Kullanım : Tasarruflu/
Led Ampul
Usage : Energy Saving/
Led Bulb

Gövde DKP Sac
Body : DKP Sheet Metal

Cam : S.A.N
Glass : S.A.N

Gofraj : Alüminyum
Embossing : Aluminium

IP Derecesi : IP20
IP Rating : IP20

Kullanım : Tasarruflu/
Led Ampul
Usage : Energy Saving/
Led Bulb



Teknik veri / Datasheet

OKYANUS SOFT TAVAN ARMATÜR (2XE27 DUY)
OKYANUS SOFT CEILING ARMATURE

Ürün Kodu Product Code	Renk Color	Boyutlar (ØxH) mm Dimensions	Kutu Adeti Quantity in Box	Koli Adeti Quantity in Carton	Fiyat Price
BR-00231-010	Beyaz	345 × 105	2	12	136,20 TL

ATLANTİK TAVAN GLOP ARMATÜR (2XE27 DUY)
ATLANTİK CEILING ARMATURE

Ürün Kodu Product Code	Renk Color	Boyutlar (ØxH) mm Dimensions	Kutu Adeti Quantity in Box	Koli Adeti Quantity in Carton	Fiyat Price
BR-00231-020	Beyaz	345 × 105	2	12	127,30 TL

İNCI TAVAN ARMATÜR (1XE27 DUY)
İNCI CEILING ARMATURE

Ürün Kodu Product Code	Renk Color	Boyutlar (ØxH) mm Dimensions	Kutu Adeti Quantity in Box	Koli Adeti Quantity in Carton	Fiyat Price
BR-00206-010	Beyaz	290 × 90	2	16	162,20 TL

YAKUT TAVAN ARMATÜR (1XE27 DUY)
YAKUT CEILING ARMATURE

Ürün Kodu Product Code	Renk Color	Boyutlar (ØxH) mm Dimensions	Kutu Adeti Quantity in Box	Koli Adeti Quantity in Carton	Fiyat Price
BR-00206-000	Beyaz	290 × 90	2	16	176,45 TL

EKOTA LED DUVAR APLİK
EKOTA LED WALL LIGHTING FIXTURE



EKOLIGHT LED DUVAR APLİK
EKOLIGHT LED WALL LIGHTING FIXTURE



NEMLİYER LED DUVAR APLİK IP65
NEMLİYER LED WALL LIGHTING FIXTURE IP65



LED

3 YIL
GARANTİ

50.000
SAAT



Teknik Özellikler Technical Specifications

Gövde : ABS
Body : ABS

Cam : S.A.N
Glass : S.A.N.

Renksel Geri Verim : 80
Color Rendering Index : 80

IP Derecesi : IP20
IP Rating : IP20

Sürücü : On-Board
Driver : On-Board

EKOTA LED DUVAR APLİK EKOTA LED WALL LIGHTING FIXTURE

Ürün Kodu Product Code	Güç (W) Power	Renk Sıcaklığı (K) Color Temperature	Işık Akısı (Lm) Luminous Flux	Boyutlar (WxLxH)mm Dimensions	Kutu Adeti Quantity in Box	Koli Adeti Quantity in Carton	Fiyat Price
BL-B1-0001	12W	6500 K	960	150 × 260 × 50	2	36	\$13,10
BL-B1-0002	12W	3000 K	960	150 × 260 × 50	2	36	\$13,10

EKOLIGHT LED DUVAR APLİK EKOLIGHT LED WALL LIGHTING FIXTURE

Ürün Kodu Product Code	Güç (W) Power	Renk Sıcaklığı (K) Color Temperature	Işık Akısı (Lm) Luminous Flux	Boyutlar (WxLxH)mm Dimensions	Kutu Adeti Quantity in Box	Koli Adeti Quantity in Carton	Fiyat Price
BL-B1-0003	12W	6500 K	960	168 × 276 × 50	2	36	\$13,30
BL-B1-0004	12W	3000 K	960	168 × 276 × 50	2	36	\$13,30

NEMLİYER LED DUVAR APLİK NEMLİYER LED WALL LIGHTING FIXTURE

Ürün Kodu Product Code	Güç (W) Power	Renk Sıcaklığı (K) Color Temperature	Işık Akısı (Lm) Luminous Flux	Boyutlar (WxLxH)mm Dimensions	Kutu Adeti Quantity in Box	Koli Adeti Quantity in Carton	Fiyat Price
BL-B1-0005	12W	6500 K	750	135 × 235 × 55	2	36	\$14,00
BL-B1-0006	12W	3000 K	750	135 × 235 × 55	2	36	\$14,00



Teknik veri / Datasheet

ŞAH DUVAR APLİK ARMATÜR (1XE27 DUY)
SAH WALL LUMINAIRE



IP Derecesi : IP40
IP Rating : IP40

AYNA ÜSTÜ DUVAR APLİK ARMATÜR (2XE14 DUY)
AYNA USTU WALL LUMINAIRE

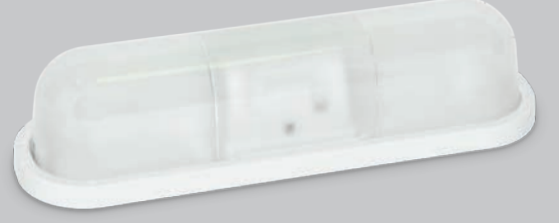

KRALIÇE DUVAR APLİK ARMATÜR (1XE27 DUY)
KRALICE WALL LUMINAIRE

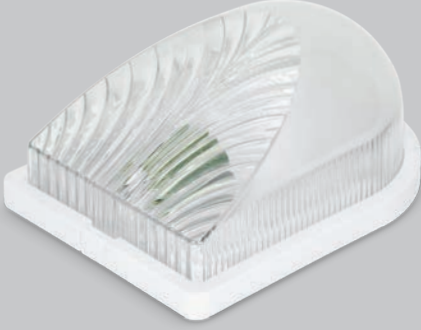

EKOTA DUVAR APLİK ARMATÜR (1XE27 DUY)
EKOTA WALL LUMINAIRE



EKOLIGHT DUVAR APLİK ARMATÜR (1XE27 DUY)
EKOLIGHT WALL LUMINAIRE



EKOSOFT DUVAR APLİK ARMATÜR (1XE27 DUY)
EKOSOFT WALL LUMINAIRE



E27

3 YIL GARANTİ



Teknik Özellikler
Technical Specifications

Gövde ABS
Body : ABS

Cam : S.A.N
Glass : S.A.N

IP Derecesi : IP20
IP Rating : IP20

Kullanım : Tasarruflu/
Led Ampul
Usage : Energy Saving/
Led Bulb

ŞAH DUVAR APLİK ARMATÜR (1XE27 DUY)

ŞAH WALL LUMINAIRE

Ürün Kodu Product Code	Renk Color	Boyutlar (WxLxH) mm Dimensions	Kutu Adeti Quantity in Box	Koli Adeti Quantity in Carton	Fiyat Price
BR-00309-000	Beyaz	150 × 87 × 230	1	48	65,95 TL

AYNA ÜSTÜ DUVAR APLİK ARMATÜR (2XE14 DUY)

AYNA USTU WALL LUMINAIRE

Ürün Kodu Product Code	Renk Color	Boyutlar (WxLxH) mm Dimensions	Kutu Adeti Quantity in Box	Koli Adeti Quantity in Carton	Fiyat Price
BR-00235-000	Beyaz	290 × 85 × 74	1	48	70,90 TL

KRALIÇE DUVAR APLİK ARMATÜR (1XE27 DUY)

KRALICE WALL LUMINAIRE

Ürün Kodu Product Code	Renk Color	Boyutlar (WxLxH) mm Dimensions	Kutu Adeti Quantity in Box	Koli Adeti Quantity in Carton	Fiyat Price
BR-00306-000	Beyaz	166 × 236 × 114	2	36	71,55 TL

EKOTA DUVAR APLİK ARMATÜR (1XE27 DUY)

EKOTA WALL LUMINAIRE

Ürün Kodu Product Code	Renk Color	Boyutlar (WxLxH) mm Dimensions	Kutu Adeti Quantity in Box	Koli Adeti Quantity in Carton	Fiyat Price
BR-00307-000	Beyaz	276 × 168 × 100	2	36	71 TL

EKOLIGHT DUVAR APLİK ARMATÜR (1XE27 DUY)

EKOLIGHT WALL LUMINAIRE

Ürün Kodu Product Code	Renk Color	Boyutlar (WxLxH) mm Dimensions	Kutu Adeti Quantity in Box	Koli Adeti Quantity in Carton	Fiyat Price
BR-00246-000	Beyaz	276 × 168 × 100	2	36	72,90 TL

EKOSOFT DUVAR APLİK ARMATÜR (1XE27 DUY)

EKOSOFT WALL LUMINAIRE

Ürün Kodu Product Code	Renk Color	Boyutlar (WxLxH) mm Dimensions	Kutu Adeti Quantity in Box	Koli Adeti Quantity in Carton	Fiyat Price
BR-00246-010	Beyaz	276 × 168 × 100	2	36	72,60 TL



Teknik veri / Datasheet

KRAL DEKORATIF DUVAR APLİK ARMATÜR (1XE27 DUY)
KRAL DECORATIVE WALL LUMINAIRE

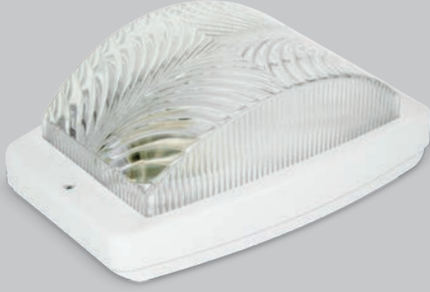

KRAL KAFESLİ DUVAR APLİK ARMATÜR (1XE27 DUY)
KRAL CAGED WALL LUMINAIRE



TAÇ DUVAR APLİK ARMATÜR (1XE27 DUY)
TAC WALL LUMINAIRE



PETEK DEKORATIF DUVAR APLİK ARMATÜR (1XE27 DUY)
PETEK DECORATIVE WALL LUMINAIRE

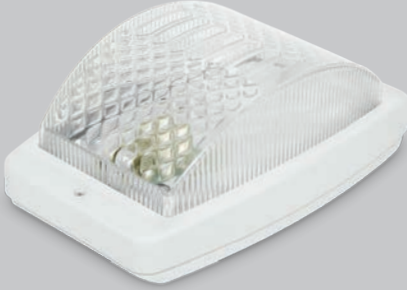

PETEK KAFESLİ DUVAR APLİK ARMATÜR (1XE27 DUY)
PETEK CAGED WALL LUMINAIRE



NEMLİYER DEKORATIF DUVAR APLİK ARMATÜR
NEMLİYER DECORATIVE WALL LUMINAIRE



IP65

NEMLİYER KAFESLİ DEKORATIF DUVAR APLİK ARMATÜR
NEMLİYER CAGED WALL LUMINAIRE



IP65



E27

3 YIL GARANTİ



Teknik Özellikler
Technical Specifications

Gövde ABS
Body : ABS

Cam : S.A.N
Glass : S.A.N

IP Derecesi : IP44
IP Rating : IP44

Kullanım : Tasarruflu/
Led Ampul
Usage : Energy Saving/
Led Bulb

KRAL DEKORATİF DUVAR APLİK ARMATÜR (1XE27 DUY)
KRAL DECORATIVE WALL LUMINAIRE

Ürün Kodu Product Code	Renk Color	Boyutlar (WxLxH) mm Dimensions	Kutu Adeti Quantity in Box	Koli Adeti Quantity in Carton	Fiyat Price
BR-00220-000	Beyaz	260 × 165 × 102	1	20	130 TL

KRAL KAFESLİ DUVAR APLİK ARMATÜR (1XE27 DUY)
KRAL CAGED WALL LUMINAIRE

Ürün Kodu Product Code	Renk Color	Boyutlar (WxLxH) mm Dimensions	Kutu Adeti Quantity in Box	Koli Adeti Quantity in Carton	Fiyat Price
BR-00220-001	Beyaz	260 × 165 × 110	1	20	139,25 TL

TAÇ DUVAR APLİK ARMATÜR (1XE27 DUY)
TAC WALL LUMINAIRE

Ürün Kodu Product Code	Renk Color	Boyutlar (WxLxH) mm Dimensions	Kutu Adeti Quantity in Box	Koli Adeti Quantity in Carton	Fiyat Price
BR-00249-000	Beyaz	240 × 120 × 120	2	36	40,90 TL

PETEK DEKORATİF DUVAR APLİK ARMATÜR (1XE27 DUY)
PETEK DECORATIVE WALL LUMINAIRE

Ürün Kodu Product Code	Renk Color	Boyutlar (WxLxH) mm Dimensions	Kutu Adeti Quantity in Box	Koli Adeti Quantity in Carton	Fiyat Price
BR-00220-010	Beyaz	260 × 165 × 102	1	20	129,75 TL

PETEK KAFESLİ DUVAR APLİK ARMATÜR (1XE27 DUY)
PETEK CAGED WALL LUMINAIRE

Ürün Kodu Product Code	Renk Color	Boyutlar (WxLxH) mm Dimensions	Kutu Adeti Quantity in Box	Koli Adeti Quantity in Carton	Fiyat Price
BR-00220-011	Beyaz	260 × 165 × 110	1	20	135,95 TL

NEMLİYER DEKORATİF DUVAR APLİK ARMATÜR (1XE27 DUY)
NEMLİYER DECORATIVE WALL LUMINAIRE

Ürün Kodu Product Code	Renk Color	Boyutlar (WxLxH) mm Dimensions	Kutu Adeti Quantity in Box	Koli Adeti Quantity in Carton	Fiyat Price
BR-00222-000	Beyaz	235 × 135 × 107	1	20	103,35 TL

NEMLİYER KAFESLİ DEKORATİF DUVAR APLİK ARMATÜR (1XE27 DUY)
NEMLİYER CAGED WALL LUMINAIRE

Ürün Kodu Product Code	Renk Color	Boyutlar (ØxH) mm Dimensions	Kutu Adeti Quantity in Box	Koli Adeti Quantity in Carton	Fiyat Price
BR-00222-001	Beyaz	235 × 135 × 120	1	20	103,70 TL



Teknik veri / Datasheet

LED ACİL ÇIKIŞ ARMATÜRÜ

LED EMERGENCY EXIT LUMINAIRE

Teknik Özellikler

Technical Specifications

Gövde : ABS
Body : ABS

Difüzör : Akrilik
Diffuser : Acrylic

IP Derecesi : IP40
IP Rating : IP40

Montaj : Sıva üstü
Mounting : Surface Mounted

Pil Türü : Nikel-Kadmiyum
Battery Type : Ni-Cd

Acilde kullanım : 3 Saat
Emergency Use : 3 Hours



ACİL ÇIKIŞ ARMATÜRÜ

Kalite standartlarına uygun gövde ve difüzör yapısı, LED aydınlatması ve şebeke voltaj dalgalanmalarına karşı Ni-Cd pil direnci ile acil durumlarda kılavuz işaretlemeler için tasarlanmış güvenilir bir armatürdür.

EMERGENCY EXIT LUMINAIRE

It is a reliable luminaire designed for guide markings in emergency conditions with its body and diffuser structure by quality standards, LED lighting and Ni-Cd battery resistance to mains voltage fluctuations.



LED ACİL ÇIKIŞ ARMATÜRÜ

LED EMERGENCY EXIT LUMINAIRE

Ürün Kodu Product Code	Güç (W) Power	Işık Akısı (Lm) Luminous Flux	Giriş Voltajı Input Voltage	Boyutlar (WxLxH) mm Dimensions	Koli Adeti Quantity in Carton	Fiyat Price
BL-AC-0002	3W	120	220-230 V AC	195 × 325 × 55	20	\$44,10

AŞAĞI YÖNLÜ



Ürün Kodu Product Code	Güç (W) Power	Işık Akısı (Lm) Luminous Flux	Giriş Voltajı Input Voltage	Boyutlar (WxLxH) mm Dimensions	Koli Adeti Quantity in Carton	Fiyat Price
BL-AC-0003	3W	120	220-230 V AC	195 × 325 × 55	20	\$44,10

İLERİ YÖNLÜ



Ürün Kodu Product Code	Güç (W) Power	Işık Akısı (Lm) Luminous Flux	Giriş Voltajı Input Voltage	Boyutlar (WxLxH) mm Dimensions	Koli Adeti Quantity in Carton	Fiyat Price
BL-AC-0004	3W	120	220-230 V AC	195 × 325 × 55	20	\$44,10

YUKARI YÖNLÜ



Teknik veri / Datasheet

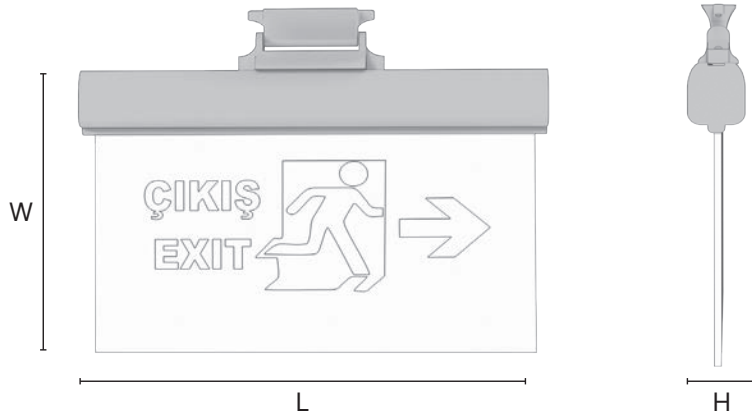

LED ACİL ÇIKIŞ ARMATÜRÜ

LED EMERGENCY EXIT LUMINAIRE

Teknik Özellikler

Technical Specifications

Gövde : Alüminyum
Body : Aluminium

Difüzör : Akrilik
Diffuser : Acrylic

IP Derecesi : IP20
IP Rating : IP20

Montaj : Sıva üstü
Mounting : Surface Mounted

Pil Türü : Nikel-Kadmiyum
Battery Type : Ni-Cd

Acilde kullanım : 3 Saat
Emergency Use : 3 Hours



LED

3
YIL
GARANTİ

50.000
SAAT

ACİL ÇIKIŞ ARMATÜRÜ

Kalite standartlarına uygun gövde ve difüzör yapısı, LED aydınlatması ve şebeke voltaj dalgalanmalarına karşı Ni-Cd pil direnci ile acil durumlarda kılavuz işaretlemeler için tasarlanmış güvenilir bir armatürdür.

EMERGENCY EXIT LUMINAIRE

It is a reliable luminaire designed for guide markings in emergency conditions with its body and diffuser structure by quality standards, LED lighting and Ni-Cd battery resistance to mains voltage fluctuations.



LED ACİL ÇIKIŞ ARMATÜRÜ

LED EMERGENCY EXIT LUMINAIRE

Ürün Kodu Product Code	Güç (W) Power	Işık Akısı (Lm) Luminous Flux	Giriş Voltajı Input Voltage	Boyutlar (WxLxH) mm Dimensions	Koli Adeti Quantity in Carton	Fiyat Price
BL-AC-0005	3W	120	220-230 V AC	145 × 330 × 23	20	Fiyat Sorunuz
BL-AC-0006	3W	120	220-230 V AC	145 × 330 × 23	20	Fiyat Sorunuz
BL-AC-0007	3W	120	220-230 V AC	145 × 330 × 23	20	Fiyat Sorunuz

İLERİ YÖNLÜ



Ürün Kodu Product Code	Güç (W) Power	Işık Akısı (Lm) Luminous Flux	Giriş Voltajı Input Voltage	Boyutlar (WxLxH) mm Dimensions	Koli Adeti Quantity in Carton	Fiyat Price
BL-AC-0008	3W	120	220-230 V AC	145 × 330 × 23	20	Fiyat Sorunuz
BL-AC-0009	3W	120	220-230 V AC	145 × 330 × 23	20	Fiyat Sorunuz

AŞAĞI YÖNLÜ



Ürün Kodu Product Code	Güç (W) Power	Işık Akısı (Lm) Luminous Flux	Giriş Voltajı Input Voltage	Boyutlar (WxLxH) mm Dimensions	Koli Adeti Quantity in Carton	Fiyat Price
BL-AC-0010	3W	120	220-230 V AC	145 × 330 × 23	20	Fiyat Sorunuz

ÇIKIŞ-EXIT



Teknik veri / Datasheet

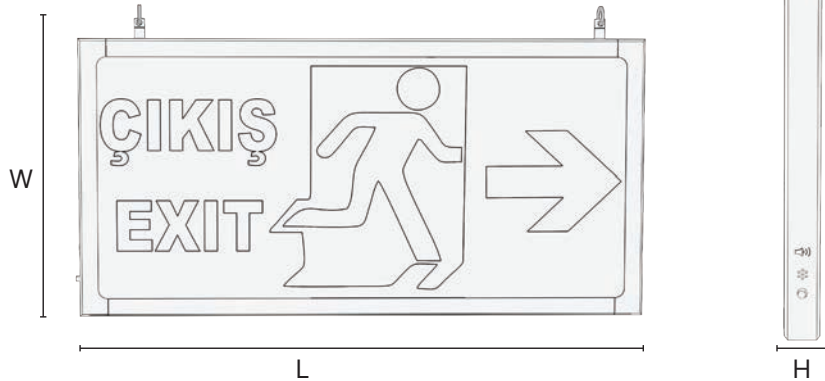

DEDEKTÖR VE SENSÖRLER DETECTOR AND SENSORS

Teknik Özellikler Technical Specifications

Gövde : ABS
Body : ABS

Gövde Renkleri : Beyaz
Body Colors : White

Kapak : ABS
Cover : ABS

Kapak Rengi : Beyaz
Cover Color : White

IIK Derecesi : IK07
IK Rating : IK07

Çalışma Sıcaklığı : -20 C / 45 C
Operating Temp. Range : -20 C / 45 C

Çalışma Gerilimi : 220-240 V AC
Operating Voltage Range : 220-240 V AC

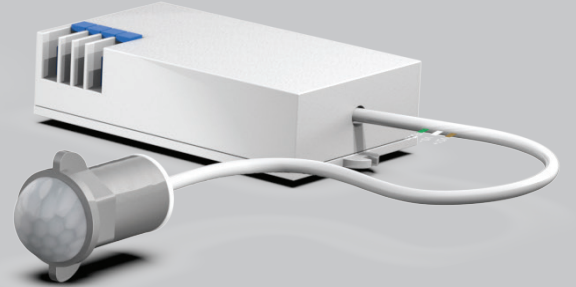

DEDEKTÖR VE SENSÖRLER

Ev ve iş yerlerinde yangın emniyeti, genel amaçlı güvenlik unsurları ve otomatik aydınlatma fonksiyonları ile enerji tasarrufu için tercih edilen ürünlerdir. Sensör, belirli dış uyarımları algılayan ve ayırt edici bir şekilde yanıt veren bir cihazdır. Dedektör, belirli bir maddeyi veya fiziksel fenomeni kaydedebilen bir cihazdır.

DETECTOR AND SENSORS

They are the products preferred for energy saving with fire safety, general-purpose security elements and automatic lighting functions in homes and workplaces. A sensor is a device that detects certain external stimuli and responds in a distinctive way. A detector is a device that can record a particular substance or physical phenomenon.



DUMAN DEDEKTÖRÜ SMOKE DETECTOR

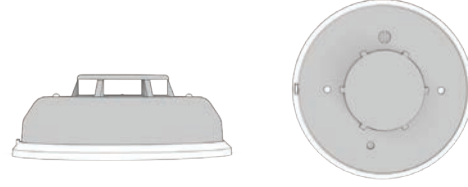

Ürün Kodu Product Code	Çalışma Gerilimi Operating Voltage	Siren Şiddeti Siren Intensity	Montaj Yüksekliği Mounting Height	Çalışma Sıcaklığı Operating Temp.	Koli Adeti Quantity in Carton	Fiyat Price
BR-DD001	9V DC	80dB	3m	-10°C - +50°C	100	\$11,00

MİNİ SENSÖR MINI SENSOR

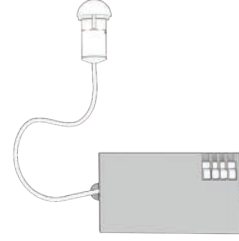

Ürün Kodu Product Code	Güç (W) Power	Akım Flow	Montaj Yüksekliği Mounting Height	Çalışma Sıcaklığı Operating Temp.	Algılama Mesafesi Detection Distance	Giriş Voltajı Input Voltage	Frekans Frequency	Koli Adeti Quantity in Carton	Fiyat Price
BR-MS001	1200W	Max 10 A	2.2 - 4m	-10°C - +40°C	Max 8m	220-240	50-60Hz	200	12,75

SIVA ALTI 360° SENSÖR FLUSH MOUNTED 360° SENSOR

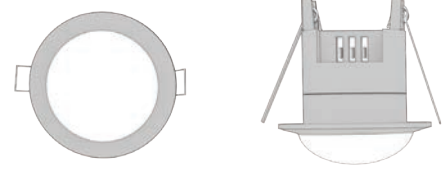

Ürün Kodu Product Code	Giriş Voltajı Input Voltage	Frekans Frequency	Montaj Yüksekliği Mounting Height	Çalışma Sıcaklığı Operating Temp.	Anma Yüğü Rated Load	Algılama Derecesi Detection Degree	Algılama Mesafesi Detection Distance	Koli Adeti Quantity in Carton	Fiyat Price
BR-SA360	220-240V AC	50Hz	2.5 - 3.5 m	-20°C - +40°C	"Max 1200W Tungsten Max 300W Florasan"	360°	Max 6m	100	\$11,30

SIVA ÜSTÜ 360° SENSÖR SURFACE MOUNTED 360° SENSOR

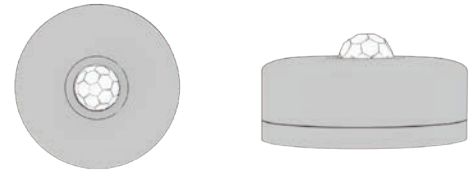

Ürün Kodu Product Code	Giriş Voltajı Input Voltage	Frekans Frequency	Montaj Yüksekliği Mounting Height	Çalışma Sıcaklığı Operating Temp.	Anma Yüğü Rated Load	Algılama Derecesi Detection Degree	Algılama Mesafesi Detection Distance	Koli Adeti Quantity in Carton	Fiyat Price
BR-SU360	220-240V AC	50Hz	2.2 - 4 m	-20°C - +40°C	Max 1200W Tungsten Max 300W Florasan"	360°	Max 8m	100	\$10,70



RADAR SENSÖR RADAR SENSOR

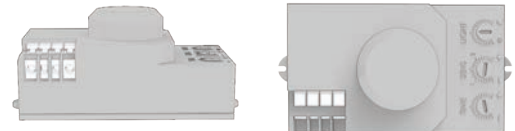

Ürün Kodu Product Code	Güç (W) Power	Akım Flow	Koruma Sınıfı Protection Class	Algılama Mesafesi Detection Distance	Giriş Voltajı Input Voltage	Frekans Frequency	Koli Adeti Quantity in Carton	Fiyat Price
BR-RS001	1200W	10A	IP20	2-8m	220-240	50-60Hz	200	\$13,40

Teknik veri / Datasheet

ŞERİT LED LED STRIP

Teknik Özellikler Technical Specifications

Şerit Led
Led Strip

Çalışma Gerilimi : 220-240 V AC
Operating Voltage Range : 220-240 V AC

IP Derecesi : IP20
IP Rating : IP20

IK Derecesi : IK07
IK Rating : IK07

Çalışma Sıcaklığı : -20 C / 45 C
Operating Temp. Range : -20 C / 45 C



NEON ŞERİT LED NEON LED STRIP

Teknik Özellikler Technical Specifications

Neon Şerit Led
Neon Led Strip

Çalışma Gerilimi : 220-240 V AC
Operating Voltage Range : 220-240 V AC

IP Derecesi : IP65
IP Rating : IP65

IK Derecesi : IK07
IK Rating : IK07

Çalışma Sıcaklığı : -20 C / 45 C
Operating Temp. Range : -20 C / 45 C



ŞERİT LED

Geleneksel aydınlatma ürünlerine göre düşük güç kullanımı ve yüksek aydınlatma kalitesi, uzun ömürlü ve daha az ısı üretimi ile yüksek verimlilik. Mimari projelerden kişisel tercihlere kadar her türlü ahşap, metal, seramik, cam, duvar vb. yüzeylerde geniş bir kullanım yelpazesi sunar.

NEON ŞERİT LED

Yumuşak, esnek ve ışık geçirgen dış materyal. İç ve dış aydınlatma için maksimum konfor ve ışık verimliliği sunar. Düşük enerji tüketimi ve çevre dostu yapısı ile estetik bir aydınlatma sağlar.

LED STRIP

Compared to traditional lighting products, low power usage and high lighting quality, long life and high efficiency with less heat generation. All kinds of wood, metal, ceramic, glass, wall, etc., from architectural projects to personal preferences. It offers a wide range of uses on surfaces.

NEON LED STRIP

Soft, flexible and transparent outer material. It offers maximum comfort and light efficiency for interior and exterior lighting. It provides aesthetic lighting with its low energy consumption and environmentally friendly structure.



ŞERİT LED (4040)

LED STRIP (4040)

Ürün Kodu Product Code	Renk Color	Güç (W/Mt) Power	Gerilim (V) Voltage (V)	Işık Akısı (Lm/Mt) Luminous Flux	Çip Sayısı Number of Chips	Koli Miktarı (Mt) Box Amount	Fiyat Price
BL-SL-1001	3000 K	14.4	12V	900	60	250 Mt	\$1,20
BL-SL-1002	6500 K	14.4	12V	900	60	250 Mt	\$1,20
BL-SL-1003	Mavi	14.4	12V	120	60	250 Mt	\$1,20
BL-SL-1004	Yeşil	14.4	12V	120	60	250 Mt	\$1,20
BL-SL-1005	Amber	14.4	12V	120	60	250 Mt	\$1,20
BL-SL-1006	4000 K	14,4	12V	900	60	250 Mt	\$1,20

NEON ŞERİT LED

NEON LED STRIP

Ürün Kodu Product Code	Renk Color	Işık Akısı (Lm/Mt)	Giriş Voltajı Input Voltage	IP Derecesi IP Rating	Koli Miktarı (Mt) Box Amount	Fiyat Price
BL-NL-1001	3000 K	130	220-240 V AC	IP65	25 Mt	\$4,65
BL-NL-1002	4000 K	130	220-240 V AC	IP65	25 Mt	\$4,65
BL-NL-1003	6500 K	130	220-240 V AC	IP65	25 Mt	\$4,65
BL-NL-1004	KIRMIZI	10	220-240 V AC	IP65	25 Mt	\$4,65
BL-NL-1005	MAVİ	18	220-240 V AC	IP65	25 Mt	\$4,65
BL-NL-1006	YEŞİL	30	220-240 V AC	IP65	25 Mt	\$4,65
BL-NL-1007	AMBER	85	220-240 V AC	IP65	25 Mt	\$4,65
BL-NL-1008	RGB	10	220-240 V AC	IP65	25 Mt	\$4,65

AKSESUARLAR

ACCESSORIES

Ürün Kodu Product Code	Ürün Adı Product Name	Koli Adedi Quantity in Carton	Fiyat Price
134-2001	220-240 V AC NEON BAĞLANTI APARATI	1	Fiyat Sorunuz
134-2002	220-240 V AC NEON BAĞLANTI APARATI RGB	1	Fiyat Sorunuz
134-2003	RGB KUMANDA	1	Fiyat Sorunuz



Teknik veri / Datasheet

ŞERİT LED TRAFOLARI LED STRIP TRANSFORMERS

Teknik Özellikler Technical Specifications

Gövde : Alüminyum
Body : Aluminium

Gövde Renkleri : Metalik
Body Colors : Metallic

Kapak : Alüminyum
Cover : Aluminium

Kapak Rengi : Metalik
Cover Color : Metallic

Çalışma Gerilimi : 220-240 V AC
Operating Voltage Range : 220-240 V AC

IP Derecesi : IP20
IP Rating : IP20

IK Derecesi : IK08
IK Rating : IK08

Çalışma Sıcaklığı : -20 C / 45 C
Operating Temp. Range : -20 C / 45 C



ŞERİT LED TRAFOLARI

Neon ve şerit ledlere bağlanan çalışma mekanizmasına led trafo denir. Güvenilir ve verimli bir aydınlatma sistemi için doğru elektriksel kapasiteler ve işlevsel özellikler sağlanması önemlidir.

LED STRIP TRANSFORMERS

The operating mechanism connected to neon and strip LED's is called a led transformer. Providing the correct electrical capacities and functional properties is essential for a reliable and efficient lighting system.



ŞERİT LED TRAFOLARI LED STRIP TRANSFORMERS

Ürün Kodu Product Code	Güç Power	Gerilim (V) Voltage (V)	Akım (A) Current (A)	Boyutlar (WxLxH) mm Dimensions	Gövde Malzemesi Body Material	Koli Adeti Quantity in Carton	Fiyat Price
BL-T1-132-1599	60W	12V	5A	40 × 160 × 32	Alüminyum	50	\$11,35
BL-T1-132-1600	120W	12V	10A	46 × 190 × 37	Alüminyum	40	\$15,00
BL-T1-132-1601	150W	12V	12,5A	58 × 200 × 40	Alüminyum	40	\$20,15
BL-T1-132-1602	200W	12V	16,5A	58 × 200 × 40	Alüminyum	40	\$24,40
BL-T1-132-1603	250W	12V	20A	68 × 225 × 40	Alüminyum	32	\$27,00
BL-T1-132-1604	360W	12V	30A	68 × 225 × 42	Alüminyum	32	\$32,75

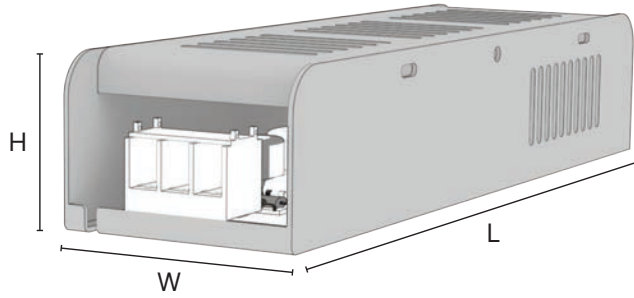

Teknik veri / Datasheet

SIVA ALTI ve SIVA ÜSTÜ HALOJEN FREE SİGORTA KUTULARI RECESSED AND SURFACE MOUNTED HALOGEN FREE FUSE BOXES

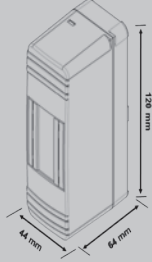

2'li Mühürlü Sigorta Kutusu

2 Module Distribution Box - Sealed

Ürün Kodu Product Code	Kutu Adedi Quantity in Box	Koli Adedi Quantity in Carton	Fiyat Price
BR-818	1	98	19,10 TL

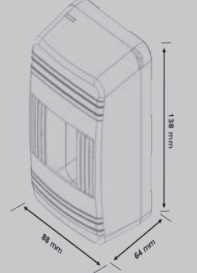

4'lü Mühürlü Sigorta Kutusu

4 Module Distribution Box - Sealed

Ürün Kodu Product Code	Kutu Adedi Quantity in Box	Koli Adedi Quantity in Carton	Fiyat Price
BR-819	1	50	28,60 TL

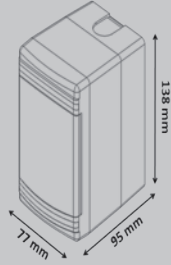

2'li Sıva Üstü Sigorta Kutusu

2 Module Distribution Box - Surface Mounted

Ürün Kodu Product Code	Kutu Adedi Quantity in Box	Koli Adedi Quantity in Carton	Fiyat Price
BR-820	2	40	63,40 TL

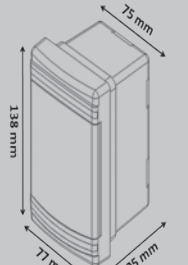

2'li Sıva Altı Sigorta Kutusu

2 Module Distribution Box - Recessed

Ürün Kodu Product Code	Kutu Adedi Quantity in Box	Koli Adedi Quantity in Carton	Fiyat Price
BR-821	2	40	57,80 TL

SIVA ALTI ve SIVA ÜSTÜ HALOJEN FREE SİGORTA KUTULARI

Standartlara uygun olarak üretilen sıva altı ve sıva üstü sigorta kutularımız Halojensiz (alev yaymayan) özelliklere sahiptir. Isıya ve darbelere dayanıklı gövdesi, geniş iç hacmi ve şeffaf yaylı kapak özellikleri ile evinizde ve iş yerinizde güvenle kullanabilirsiniz.

RECESSED AND SURFACE MOUNTED HALOGEN FREE FUSE BOXES

Our flush-mounted and surface-mounted fuse boxes, produced by the standards, have Halogen-free (non-flame-emitting) features. You can use it safely in your home and workplace with its heat and impact resistant body, large interior volume and transparent spring cover features.



SIVA ALTI ve SIVA ÜSTÜ HALOJEN FREE SİGORTA KUTULARI RECESSED AND SURFACE MOUNTED HALOGEN FREE FUSE BOXES



6'lı Sıva Üstü Sigorta Kutusu
6 Module Distribution Box - Surface Mounted

Ürün Kodu Product Code	Kutu Adedi Quantity in Box	Koli Adedi Quantity in Carton	Fiyat Price
BR-804	1	30	107,30 TL

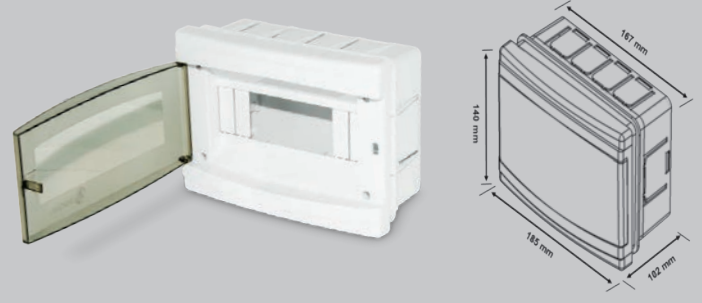

6'lı Sıva Altı Sigorta Kutusu
6 Module Distribution Box - Recessed

Ürün Kodu Product Code	Kutu Adedi Quantity in Box	Koli Adedi Quantity in Carton	Fiyat Price
BR-803	1	30	92,20 TL

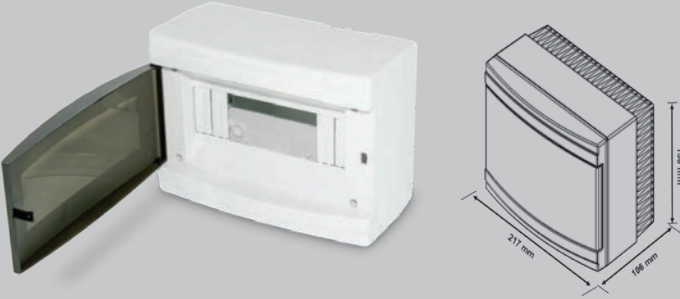

9'lı Sıva Üstü Sigorta Kutusu
9 Module Distribution Box - Surface Mounted

Ürün Kodu Product Code	Kutu Adedi Quantity in Box	Koli Adedi Quantity in Carton	Fiyat Price
BR-806	1	20	125,60 TL



9'lı Sıva Altı Sigorta Kutusu
9 Module Distribution Box - Recessed

Ürün Kodu Product Code	Kutu Adedi Quantity in Box	Koli Adedi Quantity in Carton	Fiyat Price
BR-805	1	20	109,55 TL



12'li Sıva Üstü Sigorta Kutusu
12 Module Distribution Box - Surface Mounted

Ürün Kodu Product Code	Kutu Adedi Quantity in Box	Koli Adedi Quantity in Carton	Fiyat Price
BR-808	1	20	163,15 TL



12'li Sıva Altı Sigorta Kutusu
12 Module Distribution Box - Recessed

Ürün Kodu Product Code	Kutu Adedi Quantity in Box	Koli Adedi Quantity in Carton	Fiyat Price
BR-807	1	20	144,70 TL



SIVA ALTI ve SIVA ÜSTÜ HALOJEN FREE SİGORTA KUTULARI RECESSED AND SURFACE MOUNTED HALOGEN FREE FUSE BOXES



16'li Siva Üstü Sigorta Kutusu
16 Module Distribution Box - Surface Mounted

Ürün Kodu Product Code	Kutu Adedi Quantity in Box	Koli Adedi Quantity in Carton	Fiyat Price
BR-816	1	10	225,50 TL



16'li Siva Altı Sigorta Kutusu
16 Module Distribution Box - Recessed

Ürün Kodu Product Code	Kutu Adedi Quantity in Box	Koli Adedi Quantity in Carton	Fiyat Price
BR-815	1	10	209,90 TL



18'li Siva Üstü Sigorta Kutusu
18 Module Distribution Box - Surface Mounted

Ürün Kodu Product Code	Kutu Adedi Quantity in Box	Koli Adedi Quantity in Carton	Fiyat Price
BR-814	1	10	223,80 TL



18'li Siva Altı Sigorta Kutusu
18 Module Distribution Box - Recessed

Ürün Kodu Product Code	Kutu Adedi Quantity in Box	Koli Adedi Quantity in Carton	Fiyat Price
BR-813	1	10	204,30 TL

SIVA ALTI ve SIVA ÜSTÜ HALOJEN FREE SİGORTA KUTULARI

Standartlara uygun olarak üretilen siva altı ve siva üstü sigorta kutularımız Halojensiz (alev yaymayan) özelliklere sahiptir. Isıya ve darbelere dayanıklı gövdesi, geniş iç hacmi ve şeffaf yaylı kapak özellikleri ile evinizde ve iş yerinizde güvenle kullanabilirsiniz.

RECESSED AND SURFACE MOUNTED HALOGEN FREE FUSE BOXES

Our flush-mounted and surface-mounted fuse boxes, produced by the standards, have Halogen-free (non-flame-emitting) features. You can use it safely in your home and workplace with its heat and impact resistant body, large interior volume and transparent spring cover features.



SIVA ALTI ve SIVA ÜSTÜ HALOJEN FREE SİGORTA KUTULARI RECESSED AND SURFACE MOUNTED HALOGEN FREE FUSE BOXES



24'lü Sıva Üstü Sigorta Kutusu
24 Module Distribution Box - Surface Mounted

Ürün Kodu Product Code	Kutu Adedi Quantity in Box	Koli Adedi Quantity in Carton	Fiyat Price
BR-810	1	10	232,70 TL

24'lü Sıva Altı Sigorta Kutusu
24 Module Distribution Box - Recessed

Ürün Kodu Product Code	Kutu Adedi Quantity in Box	Koli Adedi Quantity in Carton	Fiyat Price
BR-809	1	10	218,95 TL



36'lü Sıva Üstü Sigorta Kutusu
36 Module Distribution Box - Surface Mounted

Ürün Kodu Product Code	Kutu Adedi Quantity in Box	Koli Adedi Quantity in Carton	Fiyat Price
BR-812	1	5	380,60 TL

36'lü Sıva Altı Sigorta Kutusu
36 Module Distribution Box - Recessed

Ürün Kodu Product Code	Kutu Adedi Quantity in Box	Koli Adedi Quantity in Carton	Fiyat Price
BR-811	1	5	353,10 TL



SIVA ALTI SAC TABANLI SİGORTA KUTUSU (PLASTİK KAPAKLI) FUSE BOX WITH SHEET BASED (PLASTIC COVER)

Teknik Özellikler Technical Specifications

Gövde : DKP
Body : DKP

Gövde Renkleri : Gri
Body Colors : Grey

Kapak : ABS
Cover : ABS

Kapak Rengi : Beyaz
Cover Color : White

Cam : S.A.N
Glass : S.A.N

IP Derecesi : IP20
IP Rating : IP20

IK Derecesi : IK06
IK Rating : IK06



SIVA ALTI SAC TABANLI ZAYIF AKIM KUTULARI WEAK CURRENT BOXES WITH FLUSH SHEET BASED

Teknik Özellikler Technical Specifications

Gövde : DKP
Body : DKP

Gövde Renkleri : Gri
Body Colors : Grey

Kapak : DKP
Cover : DKP

Kapak Rengi : Gri
Cover Color : Grey

IK Derecesi : IK08
IK Rating : IK08



SIVA ALTI SAC TABANLI SİĞORTA KUTUSU (PLASTİK KAPAKLI) FUSE BOX WITH SHEET BASED (PLASTIC COVER)

Ürün Kodu Product Code	Ürün Adı Product Name	Boyutlar (WxLxH) mm Dimensions	Kutu Adedi Quantity in Box	Koli Adedi Quantity in Carton	Fiyat Price
BR-850	16'lı Sıva Altı Sigorta Kutusu 16 Module Distribution Box - Recessed	100 × 350 × 220	1	10	Fiyat Sorunuz
BR-851	24'lü Sıva Altı Sigorta Kutusu 24 Module Distribution Box - Recessed	100 × 300 × 345	1	10	Fiyat Sorunuz

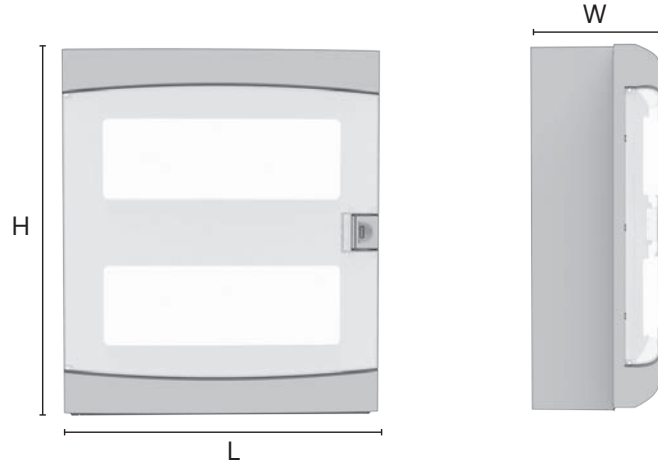

SIVA ALTI SAC TABANLI ZAYIF AKIM KUTULARI WEAK CURRENT BOXES WITH FLUSH SHEET BASED

Ürün Kodu Product Code	Ürün Adı Product Name	Boyutlar (WxLxH) mm Dimensions	Koli Adedi Quantity in Carton	Fiyat Price
BR-860	24'lü Sıva Altı Sac Zayıf Akım Kutusu 24 Flush Mounted Sheet Weak Current Box	115 × 315 × 515	1	Fiyat Sorunuz



Teknik veri / Datasheet

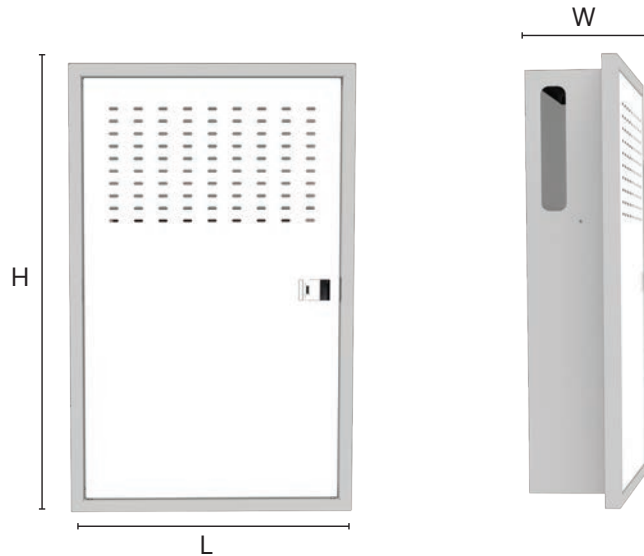

TERMOPLASTİK BUATLAR THERMOPLASTIC CONJECTIONS



Ürün Kodu Product Code	Boyutlar (WxLxH) mm Dimensions	Koli Adedi Quantity in Carton	Fiyat Price
BR-750	70×80×40	50	28,80 TL
BR-760	85×85×40	50	31,25 TL
BR-770	110×110×55	20	45,90 TL

BUAT VE DÜBELLER JUNCTION BOXES AND DOWELS



Ürün Kodu Product Code	Ürün Adı Product Name	Koli Adedi Quantity in Carton	Fiyat Price
BR-1713	Alçıpan Buat	100	9,35 TL
BR-710	Lüks Buat Kapağı	100	3,20 TL
BR-901	7 No'lu Dübel	1000	
BR-902	8 No'lu Dübel	1000	



LÜKS KARE BUATLAR LUXURIOUS SQUARE CONJECTIONS



Ürün Kodu Product Code	Boyutlar (WxLxH) mm Dimensions	Koli Adedi Quantity in Carton	Fiyat Price
BR-730	80×80×40	140	11,55 TL
BR-731	100×100×45	140	16,70 TL
BR-732	130×130×55	180	24,90 TL
BR-734	150×150×58	108	34,85 TL
BR-733	200×200×70	60	65,45 TL

GEÇMELİ ve ALÇIPAN KASA (KAPAKSIZ) INTERLACED AND DRYWALL CASE (WITHOUT COVER)

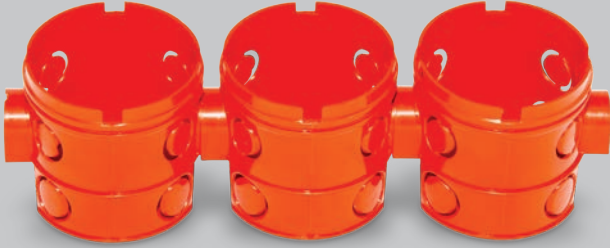

Ürün Kodu Product Code	Ürün Adı Product Name	Renk Color	Koli Adedi Quantity in Carton	Fiyat Price
BR-1413	Geçmeli Kasa Büyük	Turuncu	100	3,10 TL
BR-1708	Geçmeli Kasa Küçük	Turuncu	200	2,95 TL
BR-1712	Alçıpan Kasa	Turuncu	200	7,25 TL
BR-1413-E	Geçmeli Kasa Büyük	Siyah	100	2,90 TL
BR-1708-E	Geçmeli Kasa Küçük	Siyah	200	2,35 TL
BR-1712-E	Alçıpan Kasa	Siyah	200	6,40 TL

 Halogen Free





2'Lİ GRUP PRİZ TOPRAKLI
2 MODULE EARTHED GROUP SOCKET

Ürün Kodu Product Code	Ürün Adı Product Name	Koli Adedi Quantity in Carton	Fiyat Price
BR-1552-0	Klemensli (Kablosuz)	50	51,45 TL
BR-1552-2	2 Metre Kordonlu	12	122,35 TL
BR-1552-3	3 Metre Kordonlu	12	147,70 TL
BR-1552-5	5 Metre Kordonlu	12	200,15 TL



3'LÜ GRUP PRİZ TOPRAKLI
3 MODULE EARTHED GROUP SOCKET

Ürün Kodu Product Code	Ürün Adı Product Name	Koli Adedi Quantity in Carton	Fiyat Price
BR-1553-0	Klemensli (Kablosuz)	48	65,70 TL
BR-1553-2	2 Metre Kordonlu	12	136,75 TL
BR-1553-3	3 Metre Kordonlu	18	161,95 TL
BR-1553-5	5 Metre Kordonlu	12	214,65 TL



4'LÜ GRUP PRİZ TOPRAKLI
4 MODULE EARTHED GROUP SOCKET

Ürün Kodu Product Code	Ürün Adı Product Name	Koli Adedi Quantity in Carton	Fiyat Price
BR-1554-0	Klemensli (Kablosuz)	40	82,50 TL
BR-1554-2	2 Metre Kordonlu	12	154,20 TL
BR-1554-3	3 Metre Kordonlu	12	179,50 TL
BR-1554-5	5 Metre Kordonlu	12	229,60 TL



6'Lİ GRUP PRİZ TOPRAKLI
6 MODULE EARTHED GROUP SOCKET

Ürün Kodu Product Code	Ürün Adı Product Name	Koli Adedi Quantity in Carton	Fiyat Price
BR-1556-0	Klemensli (Kablosuz)	24	116,90 TL
BR-1556-2	2 Metre Kordonlu	12	188,10 TL
BR-1556-3	3 Metre Kordonlu	12	213,40 TL
BR-1556-5	5 Metre Kordonlu	12	263,90 TL





2'Lİ GRUP PRİZ TOPRAKLI SİYAH
2 MODULE EARTHED GROUP SOCKET BLACK

Ürün Kodu Product Code	Ürün Adı Product Name	Koli Adedi Quantity in Carton	Fiyat Price
BR-1572-0	Klemensli (Kablosuz)	50	51,45 TL
BR-1572-2	2 Metre Kordonlu	12	122,35 TL
BR-1572-3	3 Metre Kordonlu	12	147,70 TL
BR-1572-5	5 Metre Kordonlu	12	200,15 TL



3'LÜ GRUP PRİZ TOPRAKLI SİYAH
3 MODULE EARTHED GROUP SOCKET BLACK

Ürün Kodu Product Code	Ürün Adı Product Name	Koli Adedi Quantity in Carton	Fiyat Price
BR-1573-0	Klemensli (Kablosuz)	48	65,70 TL
BR-1573-2	2 Metre Kordonlu	12	136,75 TL
BR-1573-3	3 Metre Kordonlu	18	161,95 TL
BR-1573-5	5 Metre Kordonlu	12	214,65 TL



4'LÜ GRUP PRİZ TOPRAKLI SİYAH
4 MODULE EARTHED GROUP SOCKET BLACK

Ürün Kodu Product Code	Ürün Adı Product Name	Koli Adedi Quantity in Carton	Fiyat Price
BR-1574-0	Klemensli (Kablosuz)	40	82,50 TL
BR-1574-2	2 Metre Kordonlu	12	154,20 TL
BR-1574-3	3 Metre Kordonlu	12	179,50 TL
BR-1574-5	5 Metre Kordonlu	12	229,60 TL



6'Lİ GRUP PRİZ TOPRAKLI SİYAH
6 MODULE EARTHED GROUP SOCKET BLACK

Ürün Kodu Product Code	Ürün Adı Product Name	Koli Adedi Quantity in Carton	Fiyat Price
BR-1576-0	Klemensli (Kablosuz)	24	116,90 TL
BR-1576-2	2 Metre Kordonlu	12	188,10 TL
BR-1576-3	3 Metre Kordonlu	12	213,40 TL
BR-1576-5	5 Metre Kordonlu	12	263,90 TL





2'Lİ GRUP PRİZ TOPRAKLI ANAHTARLI
2 MODULE EARTHED GROUP SOCKET WITH SWITCH

Ürün Kodu Product Code	Ürün Adı Product Name	Koli Adedi Quantity in Carton	Fiyat Price
BR-1562-0	Klemensli (Kablosuz)	48	82,95 TL
BR-1562-2	2 Metre Kordonlu	12	151,90 TL
BR-1562-3	3 Metre Kordonlu	12	179,40 TL
BR-1562-5	5 Metre Kordonlu	12	229,90 TL



3'LÜ GRUP PRİZ TOPRAKLI ANAHTARLI
3 MODULE EARTHED GROUP SOCKET WITH SWITCH

Ürün Kodu Product Code	Ürün Adı Product Name	Koli Adedi Quantity in Carton	Fiyat Price
BR-1563-0	Klemensli (Kablosuz)	40	97,95 TL
BR-1563-2	2 Metre Kordonlu	12	168,25 TL
BR-1563-3	3 Metre Kordonlu	12	193,90 TL
BR-1563-5	5 Metre Kordonlu	12	244,50 TL



4'LÜ GRUP PRİZ TOPRAKLI ANAHTARLI
4 MODULE EARTHED GROUP SOCKET WITH SWITCH

Ürün Kodu Product Code	Ürün Adı Product Name	Koli Adedi Quantity in Carton	Fiyat Price
BR-1564-0	Klemensli (Kablosuz)	25	117,35 TL
BR-1564-2	2 Metre Kordonlu	12	185,70 TL
BR-1564-3	3 Metre Kordonlu	12	211,30 TL
BR-1564-5	5 Metre Kordonlu	12	261,90 TL



6'Lİ GRUP PRİZ TOPRAKLI ANAHTARLI
6 MODULE EARTHED GROUP SOCKET WITH SWITCH

Ürün Kodu Product Code	Ürün Adı Product Name	Koli Adedi Quantity in Carton	Fiyat Price
BR-1566-0	Klemensli (Kablosuz)	40	147,50 TL
BR-1566-2	2 Metre Kordonlu	20	215,60 TL
BR-1566-3	3 Metre Kordonlu	20	241,00 TL
BR-1566-5	5 Metre Kordonlu	16	293,10 TL





2'Lİ GRUP PRİZ TOPRAKLI ANAHTARLI SİYAH
2 MODULE EARTHED GROUP SOCKET WITH SWITCH BLACK

3'LÜ GRUP PRİZ TOPRAKLI ANAHTARLI SİYAH
3 MODULE EARTHED GROUP SOCKET WITH SWITCH BLACK

Ürün Kodu Product Code	Ürün Adı Product Name	Koli Adedi Quantity in Carton	Fiyat Price
BR-1592-0	Klemensli (Kablosuz)	48	82,95 TL
BR-1592-2	2 Metre Kordonlu	12	151,90 TL
BR-1592-3	3 Metre Kordonlu	12	179,40 TL
BR-1592-5	5 Metre Kordonlu	12	229,90 TL

Ürün Kodu Product Code	Ürün Adı Product Name	Koli Adedi Quantity in Carton	Fiyat Price
BR-1593-0	Klemensli (Kablosuz)	40	97,95 TL
BR-1593-2	2 Metre Kordonlu	12	168,25 TL
BR-1593-3	3 Metre Kordonlu	12	193,90 TL
BR-1593-5	5 Metre Kordonlu	12	244,50 TL



4'LÜ GRUP PRİZ TOPRAKLI ANAHTARLI SİYAH
4 MODULE EARTHED GROUP SOCKET WITH SWITCH BLACK

6'LI GRUP PRİZ TOPRAKLI ANAHTARLI SİYAH
6 MODULE EARTHED GROUP SOCKET WITH SWITCH BLACK

Ürün Kodu Product Code	Ürün Adı Product Name	Koli Adedi Quantity in Carton	Fiyat Price
BR-1594-0	Klemensli (Kablosuz)	25	117,35 TL
BR-1594-2	2 Metre Kordonlu	12	185,70 TL
BR-1594-3	3 Metre Kordonlu	12	211,30 TL
BR-1594-5	5 Metre Kordonlu	12	261,90 TL

Ürün Kodu Product Code	Ürün Adı Product Name	Koli Adedi Quantity in Carton	Fiyat Price
BR-1596-0	Klemensli (Kablosuz)	40	147,50 TL
BR-1596-2	2 Metre Kordonlu	20	215,60 TL
BR-1596-3	3 Metre Kordonlu	20	241,00 TL
BR-1596-5	5 Metre Kordonlu	16	293,10 TL





2'Lİ GRUP PRİZ TOPRAKSIZ 2 MODULE GROUP SOCKET WITHOUT EARTH

Ürün Kodu Product Code	Ürün Adı Product Name	Koli Adedi Quantity in Carton	Fiyat Price
BR-1542-0	Klemensli (Kablosuz)	50	36,00 TL
BR-1542-2	2 Metre Kordonlu	12	79,45 TL
BR-1542-3	3 Metre Kordonlu	12	93,70 TL
BR-1542-5	5 Metre Kordonlu	12	124,60 TL



3'LÜ GRUP PRİZ TOPRAKSIZ 3 MODULE GROUP SOCKET WITHOUT EARTH

Ürün Kodu Product Code	Ürün Adı Product Name	Koli Adedi Quantity in Carton	Fiyat Price
BR-1543-0	Klemensli (Kablosuz)	50	44,90 TL
BR-1543-2	2 Metre Kordonlu	12	87,95 TL
BR-1543-3	3 Metre Kordonlu	12	102,20 TL
BR-1543-5	5 Metre Kordonlu	12	132,40 TL



4'LÜ GRUP PRİZ TOPRAKLI UPS 4 MODULE EARTHED GROUP SOCKET FOR UPS

Ürün Kodu Product Code	Ürün Adı Product Name	Koli Adedi Quantity in Carton	Fiyat Price
BR-1584-0	Klemensli (Kablosuz)	40	99,65 TL
BR-1584-2	2 Metre Kordonlu	12	171,20 TL
BR-1584-3	3 Metre Kordonlu	12	196,35 TL
BR-1584-5	5 Metre Kordonlu	12	246,65 TL



6'Lİ GRUP PRİZ TOPRAKLI UPS 6 MODULE EARTHED GROUP SOCKET FOR UPS

Ürün Kodu Product Code	Ürün Adı Product Name	Koli Adedi Quantity in Carton	Fiyat Price
BR-1586-0	Klemensli (Kablosuz)	24	137,00 TL
BR-1586-2	2 Metre Kordonlu	12	206,30 TL
BR-1586-3	3 Metre Kordonlu	12	231,50 TL
BR-1586-5	5 Metre Kordonlu	12	282,00 TL





3'LÜ BUKET PRİZ 3 GROUNDED TRIPLE PLUG SOCKET BUKET

Ürün Kodu Product Code	Ürün Adı Product Name	Koli Adedi Quantity in Carton	Fiyat Price
BR-1514	Buket 3'lü Topraklı Fiş Priz	36	79,65 TL

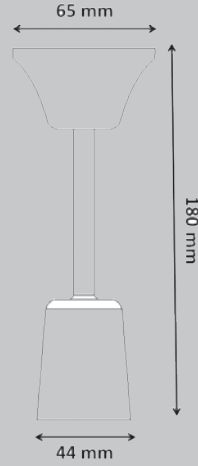

ASKI TAKIMI HANGER SET

Ürün Kodu Product Code	Ürün Adı Product Name	Koli Adedi Quantity in Carton	Fiyat Price
BR-001411	Askı Takımı Suspendent Lamp Holder Set	100	15,60 TL

E27 PORSELEN DUY E27 PORCELAIN

Ürün Kodu Product Code	Ürün Adı Product Name	Koli Adedi Quantity in Carton	Fiyat Price
132-1535	E27 Porselen Duy	400	5,10 TL

GU10 DUY GU10

Ürün Kodu Product Code	Ürün Adı Product Name	Koli Adedi Quantity in Carton	Fiyat Price
BR-GU-0001	Gu10 Duy	100	6,15 TL

AKSESUARLAR ACCESSORIES

Ürün Kodu Product Code	Ürün Adı Product Name	Kutu Adedi Quantity in box	Koli Adedi Quantity in Carton	Fiyat Price
BR-1510	Monofaze Erkek Fiş Single Phase Male Plug	50	900	20,75 TL
BR-1511	Topraklı Erkek Fiş Earthed Male Plug	50	600	26,15 TL
BR-1515	Topraklı Dişi Fiş Earthed Female Plug	40	480	28,75 TL
BR-1516	L Tipi Topraklı Erkek Fiş L Type Earthed Male Plug	50	600	22,40 TL



Teknik Özellikler Technical Specifications

Gövde : ABS
Body : ABS

Gövde Renkleri : Beyaz
Body Color : White

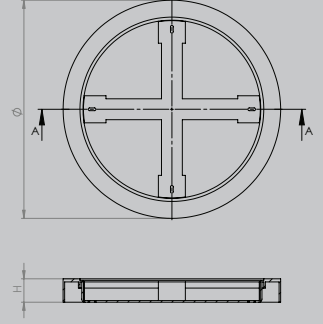
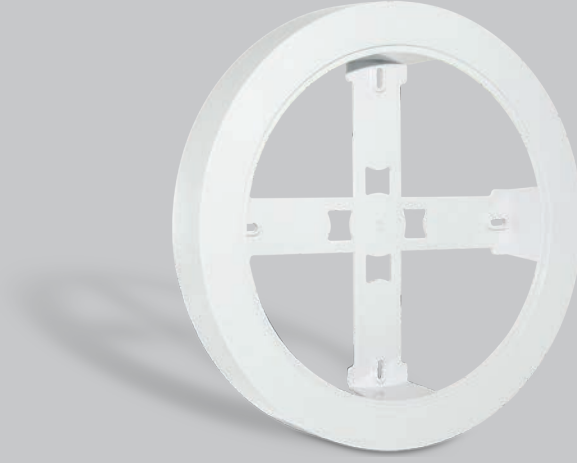

YUVARLAK SLİM LED SIVA ÜSTÜ ÇERÇEVE ROUND SIM LED SURFACE MOUNTED FRAME

Ürün Kodu Product Code	Güç (W) Power	Ürün Adı Product Name	Boyutlar (ØxH) mm Dimensions	Koli Adedi Quantity in Carton	Fiyat Price
BR-1519	18W	Plastik Siva Üstü Yuvarlak Çerçeve	275 × 38	36	62,30 TL
BR-1522	24W	Plastik Siva Üstü Yuvarlak Çerçeve	355 × 38	34	82,75 TL

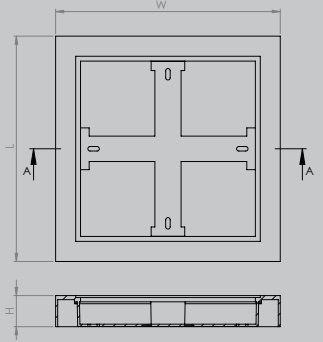
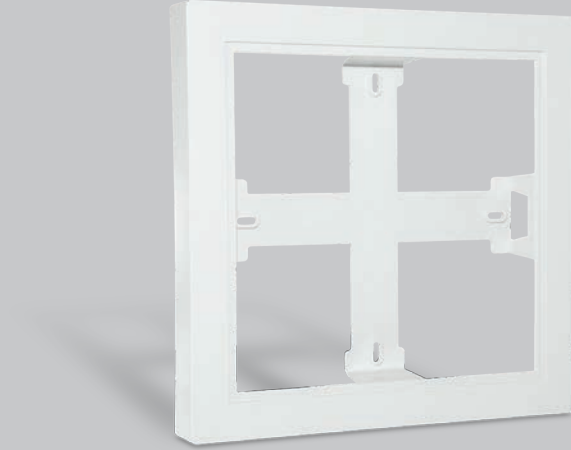

KARE SLİM LED SIVA ÜSTÜ ÇERÇEVE SQUARE SLIM LED SURFACE MOUNTED FRAME

Ürün Kodu Product Code	Güç (W) Power	Ürün Adı Product Name	Boyutlar (WxLxH) mm Dimensions	Koli Adedi Quantity in Carton	Fiyat Price
BR-1521	18W	Plastik Siva Üstü Kare Çerçeve	275 × 275 × 38	36	71,80 TL
BR-1520	24W	Plastik Siva Üstü Kare Çerçeve	355 × 355 × 38	34	98,55 TL



Teknik Özellikler
Technical Specifications

Gövde : DKP Sac
Body : DKP Metal Sheet

Gövde Renkleri : Beyaz
Body Color : White

30X30 KARE SLIM LED CLIP-IN ÇERÇEVE
30X30 SQUARE SLIM LED CLIP-IN FRAME

Ürün Kodu Product Code	Ürün Adı Product Name	Koli Adedi Quantity in Carton	Fiyat Price
134-0922	Diş Çerçeve 30×30 Led Slim Kare Clip-In Kasa	24	



60X60 KARE SLIM PANEL CLIP-IN ÇERÇEVE
60X60 SQUARE SLIM PANEL CLIP-IN FRAME

Ürün Kodu Product Code	Ürün Adı Product Name	Koli Adedi Quantity in Carton	Fiyat Price
134-1005	Diş Çerçeve 60×60 Led Slim Kare Clip-In Kasa	6	



KARE SLIM PANEL SIVA ÜSTÜ ÇERÇEVE
SQUARE SLIM PANEL SURFACE MOUNTED FRAME

Ürün Kodu Product Code	Ürün Adı Product Name	Koli Adedi Quantity in Carton	Fiyat Price
134-0995	LED 30X30 SIVA ÜSTÜ DEMONTE KASA	24	
134-0983	LED 30X60 SIVA ÜSTÜ DEMONTE KASA	12	
134-0963	LED 60X60 SIVA ÜSTÜ DEMONTE KASA	6	
134-0984	LED 30X120 SIVA ÜSTÜ DEMONTE KASA	6	



Teknik veri / Datasheet

SIKMALI KABLO PABUCU/KONEKTÖRÜ CABLE CONNECTOR STANDARD SERIES

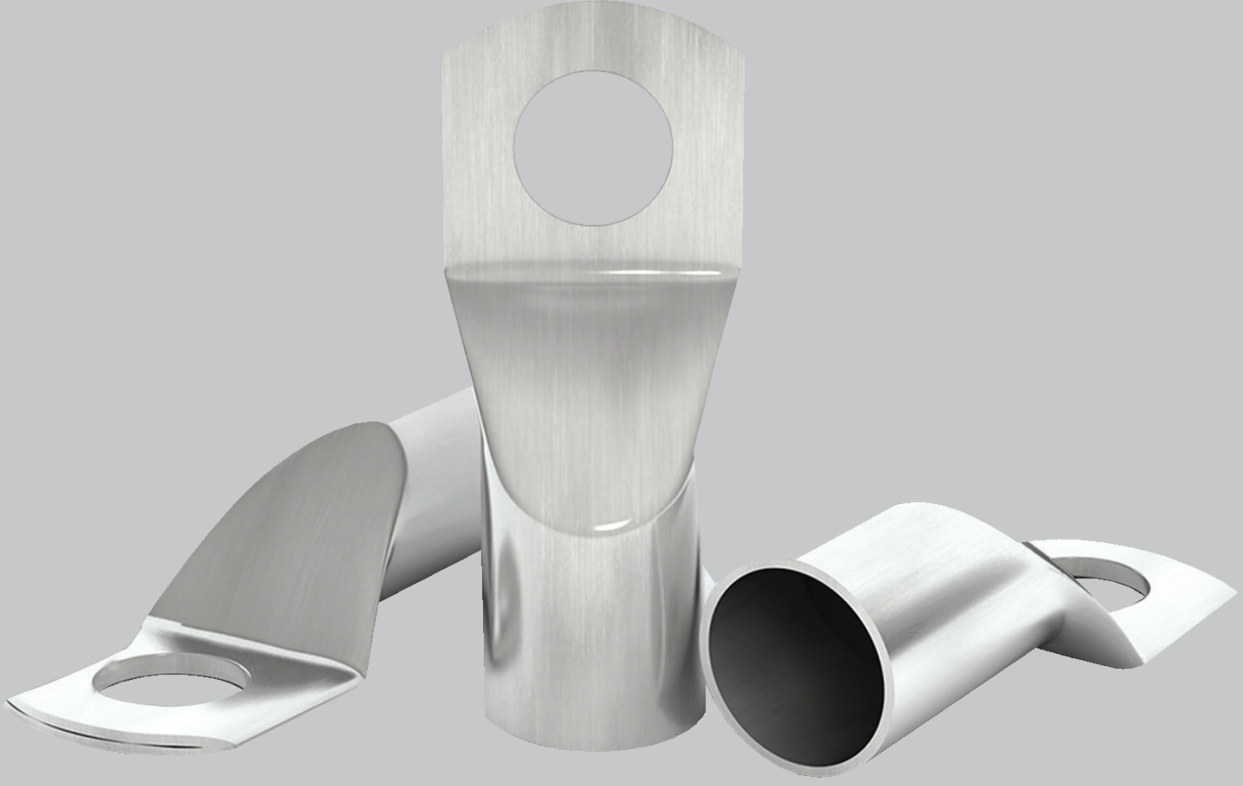

Teknik veri / Datasheet

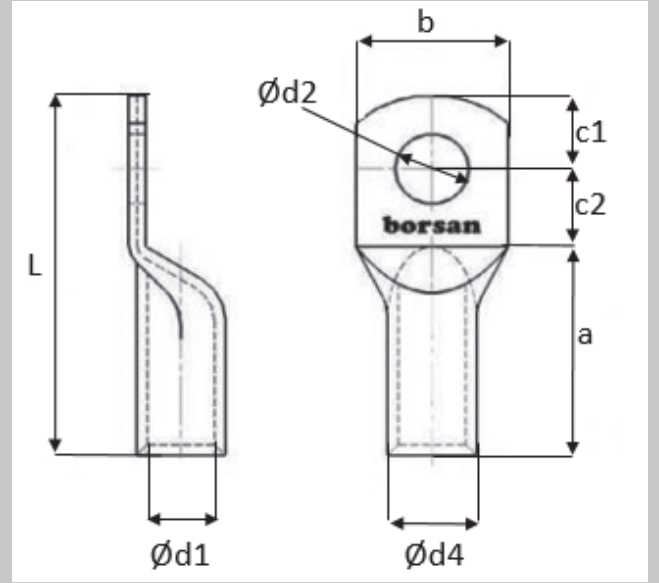

SIKMALI KABLO PABUCU/KONEKTÖRÜ

Kablo papucu/konektörü, kablo uçlarına takılarak kabloyu diğer elektriksel elemanların terminal uçlarına bağlamaya yarayan işlevsel bir aksesuardır. Konektörler iki ayrı ekipmanı birbirine bağladığı gibi bakım, onarım ve demontaj işlemlerinde operatörlere kolaylık sağlar.

CABLE CONNECTOR STANDARD SERIES

The cable connector is a functional accessory that attaches to the cable ends and connects the cable to the terminal end of other electrical elements. Connectors connect two separate equipment and provide convenience to operators in maintenance, repair and disassembly processes.



SIKMALI KABLO PABUCU

CABLE LUGS STANDARD SERIES

Ürün Kodu Product Code	Kesit Section	d1	Metrik(d2) Metric(d2)	d4	Et Kalınlık Thickness	a	b	c1	c2	L	Kutu Adet Box Pcs.	Fiyat Price
BR-1780 M5	6	4,50	5,00	5,80	0,65	13,40	8,40	5,00	6,50	24,9	1500	Fiyat Sorunuz
BR-1780-M5K	6	4,50	5,00	5,80	0,65	13,40	8,40	5,00	6,50	24,9	750	Fiyat Sorunuz
BR-1781 M5	10	4,90	5,00	6,20	0,65	13,90	10,30	6,60	7,30	27,8	1100	Fiyat Sorunuz
BR-1781-M5K	10	4,90	5,00	6,20	0,65	13,90	10,30	6,60	7,30	27,8	550	Fiyat Sorunuz
BR-1782 M6	16	6,60	6,00	7,90	0,65	17,15	11,70	6,40	7,60	31,15	650	Fiyat Sorunuz
BR-1782-M6K	16	6,60	6,00	7,90	0,65	17,15	11,70	6,40	7,60	31,15	325	Fiyat Sorunuz
BR-1782-M8	16	6,60	8,00	7,90	0,65	17,15	11,70	6,40	7,60	31,15	650	Fiyat Sorunuz
BR-1782-M8K	16	6,60	8,00	7,90	0,65	17,15	11,70	6,40	7,60	31,15	325	Fiyat Sorunuz
BR-1783 M8	25	7,50	8,00	9,00	0,75	22,50	13,25	8,20	7,90	38,6	420	Fiyat Sorunuz
BR-1783-M8K	25	7,50	8,00	9,00	0,75	22,50	13,25	8,20	7,90	38,6	210	Fiyat Sorunuz
BR-1784 M8	35	8,70	8,00	10,80	1,05	24,85	15,50	9,20	10,35	44,4	250	Fiyat Sorunuz
BR-1784-M8K	35	8,70	8,00	10,80	1,05	24,85	15,50	9,20	10,35	44,4	125	Fiyat Sorunuz
BR-1794 M10	35	8,70	10,00	10,80	1,05	24,85	15,50	9,20	10,35	44,4	250	Fiyat Sorunuz
BR-1794 M10K	35	8,70	10,00	10,80	1,05	24,85	15,50	9,20	10,35	44,4	125	Fiyat Sorunuz
BR-1785 M10	50	10,30	10,00	12,60	1,15	28,90	18,20	11,50	11,15	51,55	170	Fiyat Sorunuz
BR-1785-M10K	50	10,30	10,00	12,60	1,15	28,90	18,20	11,50	11,15	51,55	85	Fiyat Sorunuz
BR-1785 M12	50	10,30	12,00	12,60	1,15	28,90	18,20	11,50	11,15	51,55	170	Fiyat Sorunuz
BR-1785 M12K	50	10,30	12,00	12,60	1,15	28,90	18,20	11,50	11,15	51,55	85	Fiyat Sorunuz
BR-1786 M10	70	11,70	10,00	14,50	1,40	33,90	21,00	10,10	11,10	55,1	110	Fiyat Sorunuz
BR-1786 M12	70	11,70	12,00	14,50	1,40	33,90	21,00	10,10	11,10	55,1	110	Fiyat Sorunuz
BR-1787 M8	95	13,80	8,00	16,50	1,35	36,70	24,20	10,55	12,05	59,3	90	Fiyat Sorunuz
BR-1787 M10	95	13,80	10,00	16,50	1,35	36,70	24,20	10,55	12,05	59,3	90	Fiyat Sorunuz
BR-1787 M12	95	13,80	12,00	16,50	1,35	36,70	24,20	10,55	12,05	59,3	90	Fiyat Sorunuz
BR-1787 M14	95	13,80	14,00	16,50	1,35	36,70	24,20	10,55	12,05	59,3	90	Fiyat Sorunuz
BR-1788 M10	120	15,90	10,00	19,10	1,60	42,55	28,20	13,90	13,60	70,05	65	Fiyat Sorunuz
BR-1788 M12	120	15,90	12,00	19,10	1,60	42,55	28,20	13,90	13,60	70,05	65	Fiyat Sorunuz
BR-1788 M14	120	15,90	14,00	19,10	1,60	42,55	28,20	13,90	13,60	70,05	65	Fiyat Sorunuz
BR-1789 M10	150	17,30	10,00	20,60	1,65	42,20	29,95	16,70	16,80	75,7	55	Fiyat Sorunuz
BR-1789 M12	150	17,30	12,00	20,60	1,65	42,20	29,95	16,70	16,80	75,7	55	Fiyat Sorunuz
BR-1789 M16	150	17,30	16,00	20,60	1,65	42,20	29,95	16,70	16,80	75,7	55	Fiyat Sorunuz
BR-1790 M12	185	19,05	12,00	22,60	1,78	46,60	33,25	17,35	18,95	82,9	35	Fiyat Sorunuz
BR-1790 M16	185	19,05	16,00	22,60	1,78	46,60	33,25	17,35	18,95	82,9	35	Fiyat Sorunuz
BR-1791 M16	240	21,55	16,00	25,20	1,83	54,30	37,25	17,35	17,95	89,6	25	Fiyat Sorunuz
BR-1792 M16	300	24,30	16,00	29,00	2,35	53,50	43,00	22,00	24,50	100	20	Fiyat Sorunuz
BR-1792 M20	300	24,30	20,00	29,00	2,35	53,50	43,00	22,00	24,50	100	20	Fiyat Sorunuz
BR-1793 M20	400	27,35	20,00	32,80	2,73	57,50	48,50	24,80	22,20	104,5	14	Fiyat Sorunuz

TEKNİK BİLGİLER

Aydınlatmada Kullanılan Lambalar

Günümüzde aydınlatmada kullanılan lambalar aşağıdaki gibidir. Önceki yıllarda yapılmış olan aydınlatma sistemleri civa buharlı lambalar yoğun olarak kullanılmaktadır. Günümüzde ise Tedaş'ın şartnamelerinde Civa buharlı lamba kullanımı yasaklanmıştır. Aşağıdaki tablodan da görüldüğü üzere teknoloji sürekli olarak gelişmekte daha yüksek ışık etkinliğine sahip ve daha uzun ömürlü ürünler seçilmektedir.

Lamba Türü	Işık Etkinliği (Lm/W)	Ömür (Saat)
Akkor lamba (Enkandesen)	8 - 16	1000
Halojen lamba (Tungsten)	12 - 26	2.000 - 4.000
Floresan lamba	45 - 100	6.000 - 15.000
Yb Civa Buharlı lamba	36 - 60	6.000 - 8.000
Metal Halide lamba	71 - 98	5.600 - 6.500
Endüksiyon	68 - 72	5.800 - 6.200
YB Sodyum Buharlı lamba	66 - 142	10.000 - 15.000
AB Sodyum Buharlı lamba	100 - 198	11.500 - 20.000
LED	80 - 165	50.000 - 100.000

Işık Akısı (LM)

Bir ışık kaynağından ışılan akının göze etkiyen kısmına ışık akısı denir. Birimi lümen dir ve ışınımın parlaklık duygusu uyandırma yeteneğini temsil eder. Toplam ışık akısı ise bir kaynaktan çıkan ve uzayın muhtelif kısımlarına yayılan ışık akılarının toplamı olarak tanımlanır. Işık enerjisinin ölçüsüdür. Diğer bir deyişle, bir ışık kaynağından toplam çıkış lümenle ifade edilir. Lümen ne kadar yüksek ışık ise o kadar parlak gözükür. (1 lümen = 0.00146 W)

Aydınlık Düzeyi (Lux)

Birim yüzeye düşen toplam ışık akısı o yüzeyin aydınlık düzeyi olarak tanımlanır ve E ile gösterilir. Birimi lux'tür. Bir Lux'ün ışınma gücü bir mum ışığına eş değerdir.

Renk Sıcaklığı (Color Temperature K)

Beyaz ışınım yapan bir ışık kaynağının sahip olduğu ışığın rengini ifade eder. Genelde eski tip enkandesen ampuller 2500K ışık rengine sahiptir. Bunun dışında 2700K sarı ışık, 3000K gün ışığı (veya sıcak beyaz), 4000K nötr beyaz, 5000-6500K soğuk beyaz ışık rengi olarak tabir edilir.

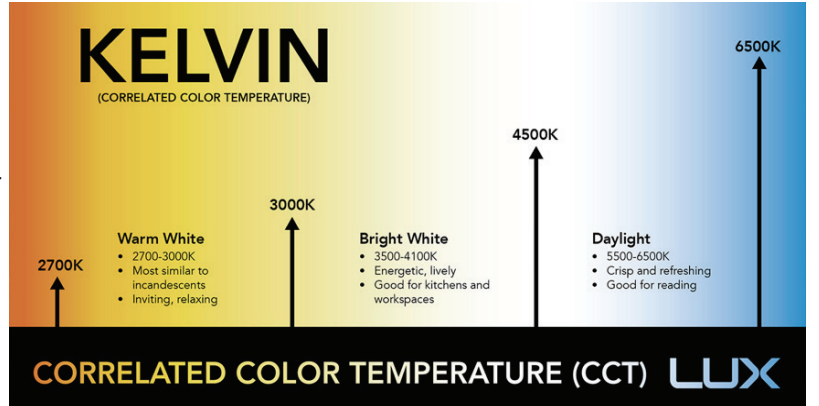

Renksel Geri Verim (CRI)

Renksel Geri Verim nesnenin belli bir ışık kaynağı altında renk kalitesini ifade eder. Yüksek CRI değerine sahip bir ışık kaynağı, renklerin daha doğal görünmesini ifade eder. Değer, 0 (çok zayıf renk sunumu) ile 100 (mükemmel renk sunumu) arasında değişmektedir. Genel olarak 80 CRI olan ışık kaynakları uygun olarak kabul edilir.



Işık Şiddeti (Cd)

Noktasal bir ışık kaynağının herhangi bir doğrultusundaki ışık şiddeti bu doğrultuyu içine alan uzay açısından çıkan ışık akısının uzay açığı bölümü olarak tanımlanır. Birimi Candela'dır ve 'cd' ile gösterilir. 1 Lümenlik ışık akısının 1 steradyanlık uzay açısından çıkması durumunda ışık şiddeti 1 cd olur.

Işık

Dalga teorisine göre ışık elektromanyetik ışınlama (radyasyon) enerjisinin gözle görülebilen bir şeklidir. Belli bir yayılma hızına frekansa ve dalga boyuna sahiptir. İnsanoğlu bu elektromanyetik dalgaların sadece dalga boyu 380 nm ile 780 nm arasında değişen ve renk olarak tanımlanan kısmını görebilir.

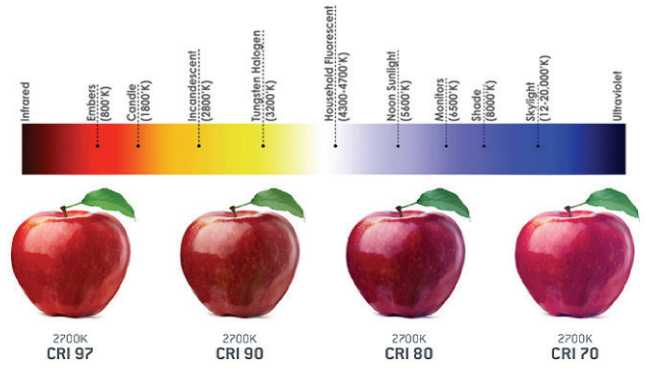

Renk

Farklı dalga boylarındaki ışınların insan beyninde yaptığı çağrışımlardır. Bir ışık demetinin rengini tayfsal özellikleri belirler.

ELECTROMAGNETİK SPECTRUM

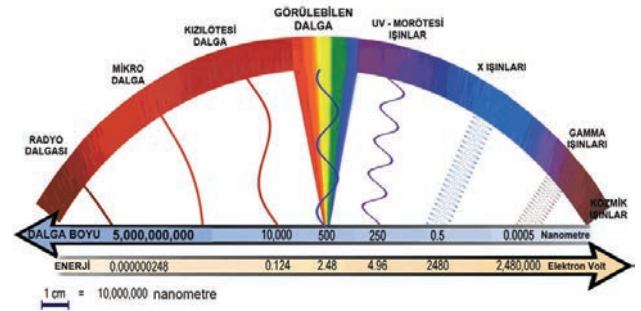

Konik Diagram

Aydınlatma ürününden çıkan ışık akısının baz alınan belli yükseklikler için ne kadarlık ışık şiddeti (lx) oluşturacağı belirtilmektedir. Aşağıdaki tabloda 90 Derece Açığı ile kullanılan armatürlerin farklı yüksekliklerde zemine vurma dağılımı gösterilmektedir. Hesaplama sonucu oluşturulan diagramda ortam koşulları hesaplamalara dahil edilmemiştir.

0.5	1.49	E(0°) E(C0)	56.2°	2018 174
1.0	2.99	E(0°) E(C0)	56.2°	504 43
1.5	4.48	E(0°) E(C0)	56.2°	224 19
2.0	5.98	E(0°) E(C0)	56.2°	126 11
2.5	7.47	E(0°) E(C0)	56.2°	81 7
3.0	8.96	E(0°) E(C0)	56.2°	56 5

Distance [m] Cone Diameter [m] Illuminance [lx]
C0 - C180 (Half value angle: 112.4°)

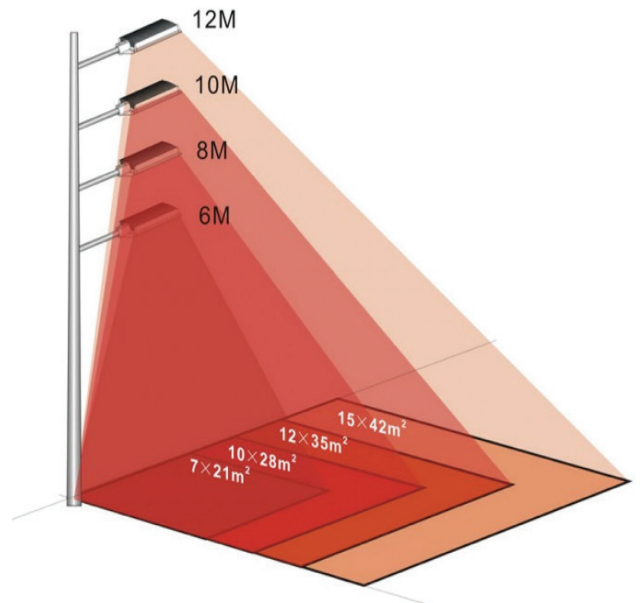

TECHNICAL DATA

Types of Light Lamps

The lighting lamps in use today are shown below table. Mercury vapor lamps were used intensively in lighting systems. As you may see from following table, technology is always improving therefore long life energy-saving and higher lighting efficiency products are being preferred.

Types of Lamps	Light efficiency (lm/W)	Lifetime (hour)
Incandescent Lamps	8 - 16	1000
Halojen Lamps (Tungsten)	12 - 26	2.000 - 4.000
Floresan Lamps	45 - 100	6.000 - 15.000
High-pressure	36 - 60	6.000 - 8.000
Mercury-vapor Lamps	71 - 98	5.600 - 6.500
Induction	68 - 72	5.800 - 6.200
High Pressure Sodium Lamps	66 - 142	10.000 - 15.000
Low Pressure Sodium Lamps	100 - 198	11.500 - 20.000
LED	80 - 165	50.000 - 100.000

Luminous Flux (LM)

The amount of light (energy) as seen by the human eye that is given off by the light bulb described as luminous flux. It is designated by the symbol F and is expressed in lumens and total luminous flux is described as sum amount of the luminous flux that emitted by a light source and spread into space sundry parts. It is unit of light energy. In other words, total outcome from a light source stated by Lumen. More lumens means it's a brighter light. (1lm=0,00146 W)

Luminous Level (Lux)

Illuminance level is the quantity of total luminous flux falling on unit area of a surface and It is designated by the symbol E. Its unit is lux. One lux equals to a candle light.

Colour Temperature (K)

Defines the color of light of a light source which emits white radiation. Old type incandescent lamps have usually 2500 K light colour. Besides that 2700 K is expressed yellow light, 3000 K is daylight(or warm white), 4000 K is pure white, 5000-6000 K is cool white.

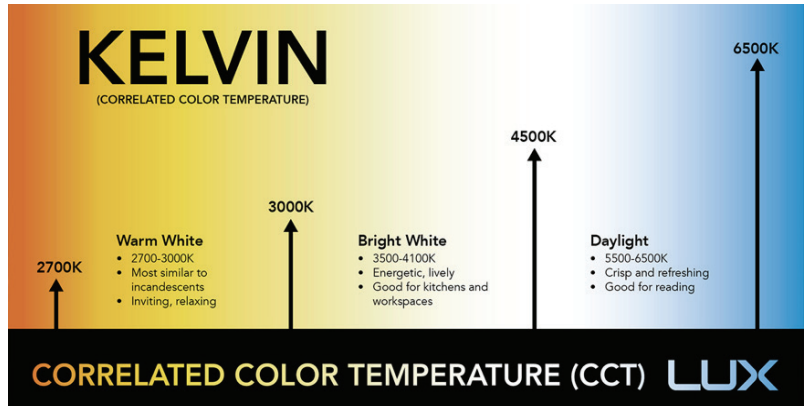

Color Rendering Index (CRI)

Colour rendering index measures the objects appear under a given light source. A light with a high CRI rating will allow an object's colours to be appeared more natural. Value of the CRI is ranging from 0 (very poor color rendition) to 100 (nearly perfect color rendition). Light sources with CPI over 80 are considered excellent for colour recognition.



Luminous Intensity (Cd)

Concentration of light emitted in a specific direction per unit time. Unit is the Candela and shown 'cd'. 1 cd luminous intensity is equal to 1 lm luminous flux emitted in 1 steradian space angle.

Light

According to wave theory, light is the way electromagnetic radiation energy that are seen to human eye. It has a specific radiation speed, frequency and wavelength. Only electromagnetic wavelengths between 380 nm and 780 nm and defined as colours are visible to human eye.

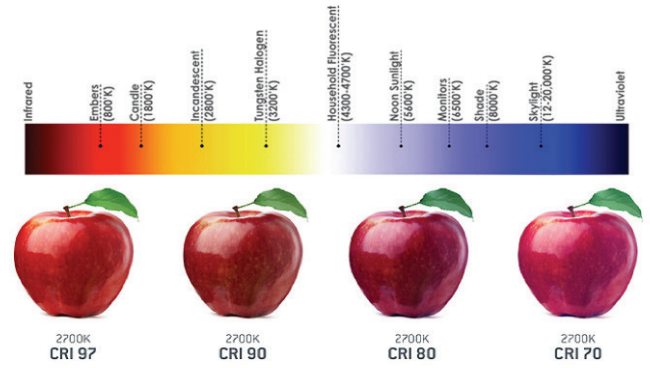

Colour

Associations of different wavelength light beam in the human brain defined as colour. The colour of a light beam is determined by spectrum.

ELECTROMAGNETİK SPECTRUM

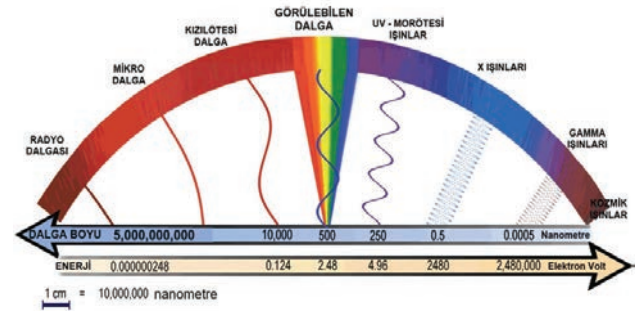

Conic Diagram

It specifies how much luminous intensity (lx) is to be produced based on certain heights by light output of lighting products. The following table shows the distribution of light hitting at different heights of Luminaires with 90 Degree Angle. Environmental conditions are not included in calculations of diagram.

0.5	1.49	E(0°) E(C0)	2018 174
1.0	2.99	E(0°) E(C0)	504 43
1.5	4.48	E(0°) E(C0)	224 19
2.0	5.98	E(0°) E(C0)	126 11
2.5	7.47	E(0°) E(C0)	81 7
3.0	8.96	E(0°) E(C0)	56 5

Distance [m] Cone Diameter [m] Illuminance [lx]
 C0 - C180 (Half value angle: 112.4°)

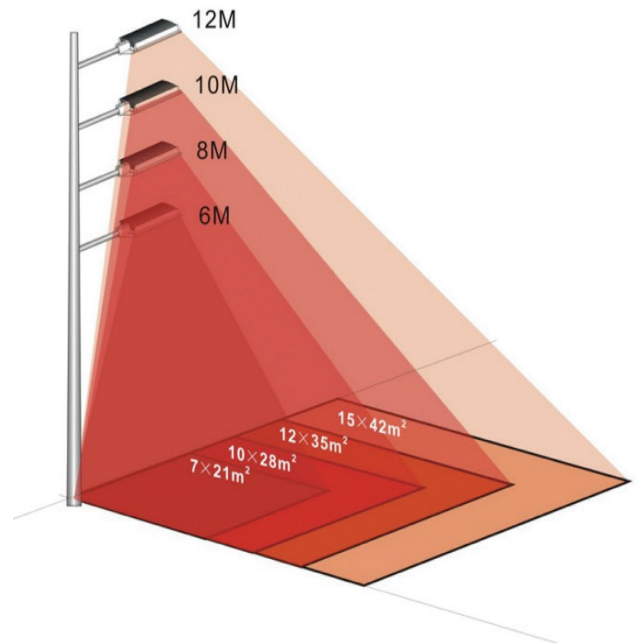







TEKNİK BİLGİLER

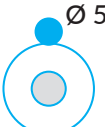
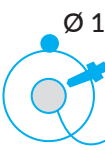
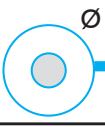

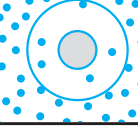
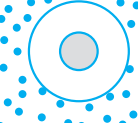



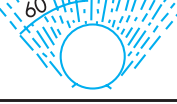

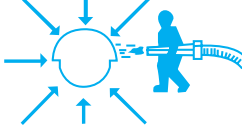
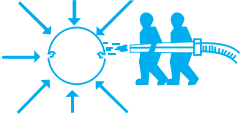
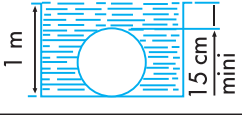
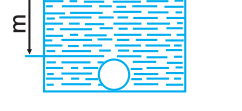















IP Koruma Sınıfı / Ingress Protection Rating (IP)

IP Kodu armatürlerin katı ve sıvı cisimlere karşı koruma göstergesidir. IP Koruma sınıfları iki rakamla gösterilir. Birinci rakam katı cisimlere karşı ikinci rakam ise sıvılara karşı korumayı gösterir. Koruması yüksek aydınlatma armatürlerinin iç kesimleri daha temiz olacağından armatürlerin reflektörleri daha iyi bir verim sağlayacaktır.

IP Code is a protection indicator of Luminaires against solid and liquid substances. IP Protection classes are indicated by two digits. The first number is against solid objects and the second number shows protection against liquids. High protected luminaires reflectors will provide better efficiency because of their cleaner inner parts.

Birinci Rakam / First Number Katı cisimlere karşı koruma / Degree of Protection (Solids)		
IP	Testler	
0	 Ø 50 mm	Korumasız Non Protection
1	 Ø 50 mm	50 mm ² 'den büyük boyutlardaki katı cisimlerden koruma Protection against large foreign bodies (diameter<50mm ²)
2	 Ø 12,5 mm	12.5 mm ² den büyük boyuttaki katı cisimlerden koruma Protection against medium foreign bodies (diameter<12.5mm ²)
3	 Ø 2,5 mm	2.5 mm ² den büyük boyuttaki katı cisimlerden koruma Protection against small foreign bodies (diameter<2.5mm ²)
4	 Ø 1 mm	1 mm ² den büyük boyuttaki katı cisimlerden koruma Protection against small foreign bodies (diameter<1mm ²)
5		Tozlardan koruma Dust Protected
6		Tozlara karşı tamamı ile koruma Dust-tight

İkinci Rakam / Second Number Sıvı cisimlere karşı koruma / Degree of Protection (Water)		
IP	Testler	
0		Korumasız Non Protection
1		Düşey olarak akan su damlalarından koruma Protection against vertical water drops
2		Düşey'le 15° lik açı yapan su damlalarından koruma Protection against inclined water drops (15° from vertical)
3		Düşey'le 60° lik açı yapan su damlalarından koruma Protection against splash water drops (60° from vertical)
4		Her yönden gelen su damlalarından koruma Protection against splash water from all directions
5		Her yönden hortum marpuçundan püsküren su fişkırtmalarından koruma Protection against water jets from any angle
6		Her yönden. deniz dalgalarına benzer şekilde çarpan suların etkisine karşı tam koruma Protection against temporary flooding
7		Suya gömülme durumunun etkilerinden koruma Protection against water submersion to 1m for 30 min
8		Belirlenmemiş koşullar altında uzun sürelerde suya gömülme durumunun etkilerinden koruma Protection against high pressure water and submersion for an indefinite time

Sembol <i>Symbol</i>	Açıklama <i>Explanation</i>	Sembol <i>Symbol</i>	Açıklama <i>Explanation</i>
	Türk Standartlarına Uygunluk Belgesi <i>Turkish Standard Compliance Certificate</i>		Yanıcı Yüzeyle Monte Edilebilir <i>Can be Mounted to flammable surfaces</i>
	Kalite Sistem Belgesi <i>Quality System Certification</i>		I.Sınıf Gövde Koruma Topraklanmış <i>1.Class of protection. The body is grounded.</i>
	ISO 14001 Kalite Sistem Belgesi <i>ISO 14001 Quality System Certification</i>		Geri Dönüşüme Uygundur <i>Suitable for recyCeiling</i>
	OHSAS 18001 Kalite Sistem Belgesi <i>OHSAS 18001 Quality System Certification</i>		Yetkili Personel Tarafından Müdahale Edilmeli <i>Must be intervened by authorized personnel</i>
	ROHS Uygunluk Sertifikası <i>RoHS Compliance Certificate</i>		IP20 Koruma Sınıfı <i>Protection Class IP 20</i>
	CE Deklarasyon Belgesi <i>CE Declaration Document</i>		IP65 Koruma Sınıfı <i>Protection Class IP 65</i>
	EAC Gümrük Birliği Belgesi <i>EAC Custom Union Certificate</i>		Eğitim Kurumları <i>Educational Institutions</i>
	Ukrayna Standartlarına Uygunluk Belgesi <i>Ukrainian Standards Compliance Certificate</i>		Yaşam Alanı <i>Living Space</i>
	Rusya Standartlarına Uygunluk Belgesi <i>Russian Standards Compliance Certificate</i>		Endüstriyel Tesisler <i>Industrial Plants</i>
	Avrupa Standartlarına Uygunluk Belgesi <i>European Standards Compliance Certificate</i>		Alışveriş Merkezleri <i>Shopping Malls</i>
	Enerji Tasarrufu <i>Energy Saving</i>		Sağlık Kuruluşları <i>Health Institutions</i>
	Alev İletmeyen Ham madde <i>Halogen Free</i>		Dış Mekan <i>Outdoor</i>
	Şebeke Gerilimi (220V) ile Çalışır <i>Works with mains voltage (220V)</i>		

MİNİMUM AYDINLIK DÜZEYLER

	LUX		LUX
KONUTLAR		X rayonu servisi (ayarlanabilir aydınlatma)	80
Oturma Odaları	500	Dişle ilgili servis büro için (genel aydınlatma)	250
Mutfaklar	250	Hasta koltuğu	5000
Yatak Odaları	250	WC	50
Giriş holü merdivenler çatı karı ambar garajlar	250	Doğum Servisi	
BÜROLAR		Annelerin yatakları	5000
Resim büroları kadastro harita	2500	Çalışma salonu (genel aydınlatma)	250
Projeler teknik resim mimari	750	Çocukların odası	100
Dekoratif resim ve krokiler	500	Bekleme salonları	100
Muhasebe ile ilgili aygıtlar	500	Hastaneler için özel odalar (genel aydınlatma)	50
Hesaplamalar	400	Yatak aydınlatması	200
Daktilo odası	500	HOTEL VE RESTORANLAR	
Belgelerin bulunduğu salon	100	Banyolar	100
Yönetim büroları	250	Aynalar (ek aydınlatma)	200
Bekleme salonları	150	Hol ve merdivenler	50
Konferans salonları	200	Mutfaklar	250
Kantinler	150	Odalar	150
OKULLAR		Yatak ucu aydınlatması	150
Yuvalar anaokulları	100	Büro masası	200
Sınıflar	200	Tuvalet masası	250
Jimnastik salonları	100	Önemli Mekanlar	
İlkokullar sınıflar	250	Konferans salonları	75
Deney sınıfları	300	Platform	200
Toplantı salonu	150	Sergileme ve tanıtımlar	150
Jimnastik salonu	150	Salonlar	50
Meslek Okulları	400	Restoranlar	75
İlk ve ortaokul düzeyindeki teknik okullar		Barlar	75
Sınıflar	250	ÇAMAŞIRHANE	
Resim sınıfları	400	Yıkama yeri	150
Atölyeler	250	Onarım sayım işaret	200
HASTANELER		Özel parça onarımı	400
Doktor Odaları	100	CAM FABRİKASI	
Çalışma masaları	400	Karıştırma	150
Genel aydınlatma	150	Fırınlama.soğutma	150
Dispanser masaları	400	Mak. İşleme salonu	150
Yedek odalar	150	Ölçüye göre kesme	200
Toplantı odası	100	Parlatma	200
Laboratuvarlar		Pahlandırma	400
Araştırma salonları	250	Gravür işleme	500
Çalışma masaları	400	Kontrol	750
Tanı ve terapi odaları(genel aydınlatma)	250	ÇELİK FABRİKASI	
Tanı masası	500	Haddehane	150
Operasyon odası (genel aydınlatma)	500	Boru çubuk tel im.	200
Operasyon masası	20000	Galvanizasyon	200
Sterilizasyon odası	400	Makine dairesi	150

MINIMUM BRIGHTNESS LEVELS

	LUX		LUX
Kalite kontrol	400	Denetleme ve lekelerin çıkarılması	1500
YÜKSEK FIRIN		Ütüleme	
Kömür ve cevher deposu	50	Makine ile ya da elle	500
Yükleme	100	Katlama ve üzerinde değişiklikler yapma	750
Kontrol kapak ları	150	TEKSTİL SANAYİ	
Fırın kapakları bakımı	100	Pamuk	
Demir kütük deposu	50	Pamukların açılıp karıştırılması ayrılması	100
Çelik fabrikası	150	Tarama makaradan geçirme iplik durumuna getirme	200
KERESTE FABRİKASI		Haddeden geçirme	400
Makine ile ilk kesme	150	Denetleme	
Y. Hassas işleme	200	Sabit parçalar	400
Hassas işleme	400	Hareketli (hızlı) parçalar	1500
KAYNAK		İpek ve sentetik telli kumaşlar	100
Genel aydınlatma	250	Koyu renkli ipliklerle çalışma	750
Hassas ark kaynağı	2500	Dokuma	400
DÖKÜMHANE		Yün	
Maça imali (Hassas)	350	Yünlerin açılıp karıştırılması ayrılması	100
Maça imali (Kaba)	200	Denetleme	400
Döküm salonu	200	Tarama, çekip uzatma, çirileme mekik geçirme	200
Temizleme parit	200	Haddeden geçirme	
Kontrol		Beyaz	200
AYAKKABI FABRİKASI		Renkli	400
Kesim ve seçme	1000	Dokuma	
Model hazırlanması	1000	Beyaz	400
İnce kesim	1000	Renkli	750
Kauçuk hazırlama	125	SERAMİK SANAYİ	
Vernikleme	200	Öğütme, filtreleme ve kurutma kompanzasyonu	100
Volkanize kesme	200	Formlama, bitirme ve temizleme	150
Taban hazırlama	400	Reklendirme ve parlatma	400
MAKİNE ATÖLYELERİ		Reklendirme ve parlatma (İnce detaylar)	750
Kaba işleme	250	MAĞAZALAR	
İnce işleme ve parlatma	400	Vitrinler	1000
Çok ince işleme	2500	Büyük kentlerdeki satın alma merkezleri (Genel aydınlatma)	1000
GİYİM SANAYİ		Spotla ek aydınlatma	5000
Kumaşların denetimi		Diğer yerlerde (Genel aydınlatma)	500
Açık renkli kumaşlar	1500	Spotla ek aydınlatma	2500
Koyu renkli kumaşlar	2500	Mağaza iç mekanı	
Kesim ve Ütüleme	750	Büyük mağazalar	1000
Açık renkli kumaşlar	500	Büyük kentlerin ticaret merkezleri	1000
Koyu renkli kumaşlar	1000	Diğer yerler	500
Dikme ve Çeşitlendirme	750	Genel mağazalar (Az uğranan bölümler)	250
Açık renkli kumaşlar	750	Fabrika mağazaları (Çok uğranılan bölümler)	300
Koyu renkli kumaşlar	1500	Büyük parçaların yeri	100
BOYAMA		Küçük parçaların yeri	200
Belirginleştirme ayırma yıkama temizleme	200	Çok küçük parçaların yeri	300

MİNİMUM AYDINLIK DÜZEYLER

	LUX		LUX
Müzeler	150	Park yerleri	50
Tablolar (bölgesel aydınlatma)	750	Sergileme salonları	400
Heykel ve diğer nesnelere	400	OTOMOBİL FABRİKALARI	
TİYATROLAR		Şasilerin toplanması.birleştirilmesi	200
Giriş ve fuaye	200	Şasilerin dizilimi	400
Salon	50	Döşemenin yapımı.çeşitli parçaların toplanıp birleştirilmesi	300
Orkestra yeri	100	Genel birleştirme	400
İbadethane	80	Bitirme ve denetleme	750
SİNEMALAR		Boya Fabrikaları	150
Giriş ve kasa	200	MATBAA	
Fuaye	50	Matris imali	400
Salon	100	Harflerin hazırlanması	200
SPOR SALONLARI		Renk ayırımı	
Stad	200	Baskı yeri	250
Futbol alanı	100	Mizampaj masası	500
Antreman alanı	25	KAĞIT FABRİKASI	
Tenis kortu	250	Karıştırma odası	150
Paten sahası	15	Kağıt makinaları	200
Paten sahası/yarışmalar için)	40	Kesme dek.	200
EKMEK FIRINLARI		Kontrol laboratuvarı	400
Karşım salonları	200	KİMYA SANAYİ	
Hamur reyonları	125	Elle çalıştırılan fırınlar sabit kurutucular ve kristalizasyon kapları	150
Fermantasyon salonu	125	Ototomatik fırınlar buharlı kazanlar damıtma kolonları	150
Hazırlama salonu	200	Koyulaştırma kazanları nitrasyon elektroliz	150
Fırınların bulunduğu salon	150	UÇAK ENDÜSTRİ	
Süsleme ve soğutma	250	Kaynak cıvata ve taşlama	250
Ambalaj salonu	150	Boya kabini	400
DEĞİRMENLER		Parçaların işlenmesi	400
Karıştırma tem.	200	İnce kaynak	250
Ambalaj salonu	100	Montaj	400
Mamul kontrolü	400	İşin tamamlanması	400
Silo temizliği	100	Kanat ve parça montajı	400
TREN İSTASYONLARI		UÇAK HANGARI	
Bekleme salonları	100	Bakım yeri	250
Bilet alma ve büroların bulunduğu yerler	400	Motor bakımı	400
Serinleme ve dinlenme salonları	150	SABUN ENDÜSTRİSİ	
Bavul emanet yeri	200	Toz sabun imali	150
Peronlar	100	Markalama paket	150
WC	100	Kalıplama ambalaj	250
GARAJLAR		TÜTÜN FABRİKASI	
Atölye	250	Kurutma	150
Tezgahtar	500	Ön hazırlama	150
Yağlama bölümleri	150	Kontrol ve seçme	200
Yağlama yerleri	250	Sigara makinaları	400



MINIMUM BRIGHTNESS LEVELS

	LUX		LUX
KONSERVE ENDÜSTRİSİ		Trafiği önemli olmayan ticari cadde	7.5
Yiyecek ayıklama	200	Trafiği olan konutlu cadde	7.5
Yıkama temizleme	200	Trafiği olmayan konutlu cadde	5
Renklerin ayrılması	300	Önemli bir çıkmaz sokak	15
Gerekli parçaları ayırma	300	Dağıtım garları	10
Kutulara koyma mek.	300	Bağımlı İşletmeler	
Kutulara koyma elle	200	Taşıma bölgeleri	20
Boş kutuların kontrolü	100	Stoklama(doldurma ve boşaltım)	20
Kutu kaynağı	300	Gözetleme aydınlatması	5
Paketleme-ambalaj	150	Girişler	50
SÜT ENDÜSTRİSİ		Yükleme platformları	50
Sterilizasyon odası	150	Trafiği olan ticari cadde	10
Pastorizasyon odası	150		
Kalıpların yıkanması	150		
Soğuk odalar	150		
Krema ayrılması	150		
Şişelerin seçimi	200		
Şişe yıkama makinası	400		
Doldurma salonu	125		
Laboratuvar	400		
ŞEKER ENDÜSTRİSİ			
Kesme karıştırma	200		
Temizleme.arıtma	400		
Renk kontrolü	750		
Depolama	50		
ELEKTRİK SANTRALİ			
Yanma hav. haz. Tesis	50		
Akümülatör dairesi	100		
Kazan bakım atölyesi	100		
Kazanların ön kısmı	50		
Kazana yakıt yük.	100		
DIŞ AYDINLATMA			
Genel halka açık aydınlatma			
Yerleşim bölgesinin dışı.ana trafik arteri	20		
Belediyeler arası anayol	15		
Belediyeler arası yol	10		
Yerleşim Bölgesinin İçi	30		
Kent içindeki hızlı dolaşım yolları	20		
Yakın yollar	20		
Tüneller(gün boyunca aydınlatma)	100		
Giriş aydınlatması	1000		
Gece aydınlatması	30		
Sanayi bölgesindeki liman ya da sokaklar	10		
Kıyı tevsiyeye havuzu ya da köprü	10		

MARKA VE YÖNETİM SİSTEMLERİ TESCİL BELGELERİ BRAND AND MANAGEMENT SYSTEMS REGISTRATION DOCUMENTS



MARKA VE YÖNETİM SİSTEMLERİ TESCİL BELGELERİ BRAND AND MANAGEMENT SYSTEMS REGISTRATION DOCUMENTS



KALİTE YÖNETİM SİSTEMİ BELGESİ

QUALITY MANAGEMENT SYSTEM CERTIFICATE



TÜRK STANDARLARI ENSTİTÜSÜ
bu belge ile

BORSAN KABLO ELEKTRİK AYDINLATMA İNŞ. SAN. VE TİC. A.Ş.
MERKEZ SANANÖĞÜLÜ ÖZEL MAH. ORGANİZE SANAYİ BULVARI NO:401 TEKEKÖY - SAMSUN
TEKSTİLSANIM FABRİKA 1 BİRİMİ KERMİNYE ÖZEL MAH. VALI M. ERDOĞAN ÇEBET BULVARI NO:34 TEKEKÖY - SAMSUN / TÜRKİYE.

kuruluşunun TS EN ISO 9001:2015 şartlarına uygun bir KALİTE YÖNETİM SİSTEMİNE sahip olduğunu onaylar.

Belge kapsamı Ek'ye verilmiştir.



TÜRK STANDARLARI ENSTİTÜSÜ
TURKISH STANDARDS INSTITUTION

TSR Kurulunca Başta Koordinatör
TSE Kurulunca Regional Coordinator

Erol KAYGI
Erol KAYGI

Türk Standartları Enstitüsü Türk Akademi Kurumu TSEKAK tarafından akredite edilmiştir.
Turkish Standards Institution, has been accredited by the Turkish Accreditation Agency TSEKAK.

TURKISH STANDARDS INSTITUTION
hereby certifies that the organization

BORSAN KABLO ELEKTRİK AYDINLATMA İNŞ. SAN. VE TİC. A.Ş.
MERKEZ SANANÖĞÜLÜ ÖZEL MAH. ORGANİZE SANAYİ BULVARI NO:401 TEKEKÖY - SAMSUN
TEKSTİLSANIM FABRİKA 1 BİRİMİ KERMİNYE ÖZEL MAH. VALI M. ERDOĞAN ÇEBET BULVARI NO:34 TEKEKÖY - SAMSUN / TURKEY.

has a QUALITY MANAGEMENT SYSTEM which fulfills the requirements of the TS EN ISO 9001:2015

Scope of the certificate is given in annex.



An belge talep edenler için
başka bir belge talep edenler için

Belge No / Certificate No	KT-0079-00-00-010
Belge Tarihi / Date of Certificate	06.06.2016
Geçerlilik Tarihi / Valid Until	06.06.2019
Denetim Tarihi / Date of Revision	06.06.2016
En Belge Tarihi / Initial Certification Date	06.06.2014

This certificate is issued on the condition that the certificate recipient is compliant with the certificate requirements in its field.

651105202202255-000



ÇEVRE YÖNETİM SİSTEMİ BELGESİ

ENVIRONMENTAL MANAGEMENT SYSTEM CERTIFICATE



TÜRK STANDARLARI ENSTİTÜSÜ
bu belge ile

BORSAN KABLO ELEKTRİK AYDINLATMA İNŞ. SAN. VE TİC. A.Ş.
MERKEZ SANANÖĞÜLÜ ÖZEL MAH. ORGANİZE SANAYİ BULVARI NO:401 TEKEKÖY - SAMSUN
TEKSTİLSANIM FABRİKA 1 BİRİMİ KERMİNYE ÖZEL MAH. VALI M. ERDOĞAN ÇEBET BULVARI NO:34 TEKEKÖY - SAMSUN / TÜRKİYE.

kuruluşunun TS EN ISO 14001:2015 şartlarına uygun bir ÇEVRE YÖNETİM SİSTEMİNE sahip olduğunu onaylar.

Belge kapsamı Ek'ye verilmiştir.



TÜRK STANDARLARI ENSTİTÜSÜ
TURKISH STANDARDS INSTITUTION

Sistem Belgelendirme Grup Başkanı
Head of System Certification Group

Mehmet Duran
Mehmet Duran

Türk Standartları Enstitüsü Türk Akademi Kurumu TSEKAK tarafından akredite edilmiştir.
Turkish Standards Institution, has been accredited by the Turkish Accreditation Agency TSEKAK.

TURKISH STANDARDS INSTITUTION
hereby certifies that the organization

BORSAN KABLO ELEKTRİK AYDINLATMA İNŞ. SAN. VE TİC. A.Ş.
MERKEZ SANANÖĞÜLÜ ÖZEL MAH. ORGANİZE SANAYİ BULVARI NO:401 TEKEKÖY - SAMSUN
TEKSTİLSANIM FABRİKA 1 BİRİMİ KERMİNYE ÖZEL MAH. VALI M. ERDOĞAN ÇEBET BULVARI NO:34 TEKEKÖY - SAMSUN / TURKEY.

has an ENVIRONMENTAL MANAGEMENT SYSTEM which fulfills the requirements of the TS EN ISO 14001:2015

Scope of the certificate is given in annex.



An belge talep edenler için
başka bir belge talep edenler için

Belge No / Certificate No	CY-0194-A-010
Belge Tarihi / Date of Certificate	16.06.2016
Geçerlilik Tarihi / Valid Until	16.06.2019
Denetim Tarihi / Date of Revision	16.06.2016
En Belge Tarihi / Initial Certification Date	16.06.2014

This certificate is issued on the condition that the certificate recipient is compliant with the certificate requirements in its field.

06280920201022001



İŞ SAĞLIĞI VE GÜVENLİĞİ YÖNETİM SİSTEMİ BELGESİ

OCCUPATIONAL HEALTH AND SAFETY MANAGEMENT SYSTEM CERTIFICATE



TÜRK STANDARLARI ENSTİTÜSÜ
bu belge ile

BORSAN KABLO ELEKTRİK AYDINLATMA İNŞ. SAN. VE TİC. A.Ş.
MERKEZ SANANÖĞÜLÜ ÖZEL MAH. ORGANİZE SANAYİ BULVARI NO:401 TEKEKÖY - SAMSUN
TEKSTİLSANIM FABRİKA 1 BİRİMİ KERMİNYE ÖZEL MAH. VALI M. ERDOĞAN ÇEBET BULVARI NO:34 TEKEKÖY - SAMSUN / TÜRKİYE.

kuruluşunun TS ISO 45001:2018 şartlarına uygun bir İŞ SAĞLIĞI VE GÜVENLİĞİ YÖNETİM SİSTEMİNE sahip olduğunu onaylar.

Belge kapsamı Ek'ye verilmiştir.



TÜRK STANDARLARI ENSTİTÜSÜ
TURKISH STANDARDS INSTITUTION

Sistem Belgelendirme Grup Başkanı
Head of System Certification Group

Mehmet Duran
Mehmet Duran

Türk Standartları Enstitüsü Türk Akademi Kurumu TSEKAK tarafından akredite edilmiştir.
Turkish Standards Institution, has been accredited by the Turkish Accreditation Agency TSEKAK.

TURKISH STANDARDS INSTITUTION
hereby certifies that the organization

BORSAN KABLO ELEKTRİK AYDINLATMA İNŞ. SAN. VE TİC. A.Ş.
MERKEZ SANANÖĞÜLÜ ÖZEL MAH. ORGANİZE SANAYİ BULVARI NO:401 TEKEKÖY - SAMSUN
TEKSTİLSANIM FABRİKA 1 BİRİMİ KERMİNYE ÖZEL MAH. VALI M. ERDOĞAN ÇEBET BULVARI NO:34 TEKEKÖY - SAMSUN / TURKEY.

has an OCCUPATIONAL HEALTH AND SAFETY MANAGEMENT SYSTEM which fulfills the requirements of the TS ISO 45001:2018

Scope of the certificate is given in annex.



An belge talep edenler için
başka bir belge talep edenler için

Belge No / Certificate No	OY-0783-A-010
Belge Tarihi / Date of Certificate	07.09.2016
Geçerlilik Tarihi / Valid Until	07.09.2019
Denetim Tarihi / Date of Revision	07.09.2016
En Belge Tarihi / Initial Certification Date	06.09.2014

This certificate is issued on the condition that the certificate recipient is compliant with the certificate requirements in its field.

062809202019170001

NOTLAR NOTES





Yaşam Alanlarınızı istediğiniz gibi Aydınlatın.

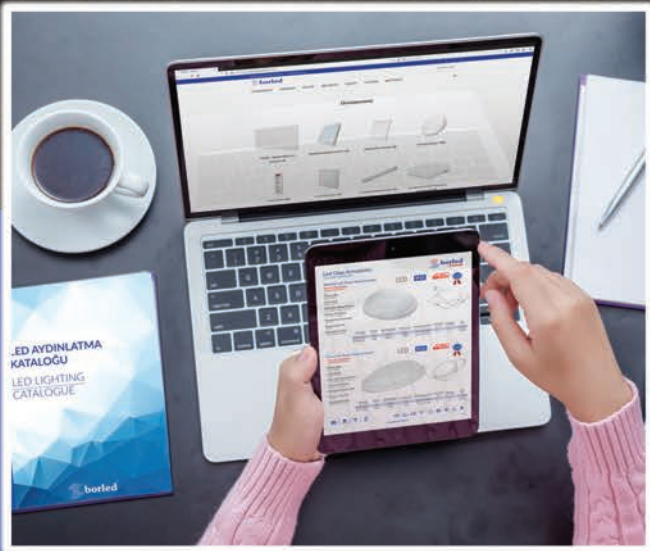

Led Aydınlatma Kataloğumuzu inceleyin.
İhtiyacınız Olan Aydınlatma Ürünleri İçin
Borled'den Bir Tıkla Teklif Alın.

www.borled.com.tr



İSTANBUL OFİS

Perpa İş Merkezi A Blok Kat: 11 No: 1337-1347
Pk: 34384 Şişli / İstanbul / Türkiye
T: +90 (212) 210 52 62-63 / F: +90 (212) 210 52 68
info@borsan.com.tr / export@borsan.com.tr

FABRİKA

Kerimbey Mah. OSB Vali M. Erdoğan Cebeci Bul. No:54
Pk: 55330 Tekkeköy / Samsun / Türkiye
T: +90 (362) 266 99 14 / F: +90 (362) 266 99 89
info@borled.com.tr