



YAKINDA



Mutlusan
electric

Akıllı Ev Sistemleri



Evinizi Yönetin

içindekiler

şalt grubu

Araç Şarjları, Akü Takviye ve Taşınabilir Şişirme Pompası	2
Şalt Ürünleri	4

anahtar priz grubu

Modüler Sistem	32
Rita Premium Serisi	39
Rita Serisi	41
Elitra Plus Serisi	48
Candela Serisi	53
Bella Serisi	59
Nora Serisi	61
Bron Serisi	63
Grup priz ve aksesuarlar	65

kablo kanalları, plastik, tesisat ve aydınlatma grubu

Canalex serisi kapalı tip kablo kanalları	74
Eko serisi kapalı tip kablo kanalları	74
Yapışkan bantlı kapalı tip kablo kanalları	74
Meks serisi kapalı tip kablo kanalları	75
Meks serisi klima kanalı ve aksesuarları	76
Tavan köşe ve süpürgelik kablo kanalları	76
Tezgah süpürgeliği	76
Balık sırtı zemin kanalları	76
H.Free Flaret kanal ve aksesuarları	77
Kanal aksesuarları	78
Meks plus serisi için priz setleri	81
Kanal için ups ve enerji prizleri 45x45	82
Sidem serisi renkli kablo kanalları	83
Sidem serisi süpürgelikler ve aksesuarları	83
Comfort W otomat kutuları	88
Comfort zayıf akım kutuları	89
Meksbox W otomat kutuları	90
H. Free spiraller	91
Plastik spiraller	92
Hdpe koruge borular	92
Rögar kutuları	92
Eko serisi çelik ve izole kaplı spiraller	93
Meks serisi çelik ve izole kaplı spiraller	94
PVC boy borular	95
PVC Boru aksesuarları	95
H.Free borular	96
Eko Serisi borular	97
Kalın boy boru ve dirsek-muflar	99
Polietilen yeraltı boruları	99
Fiber kılavuz, çelik susta ve plastik sustalar	100
Kasa, buat ve kapakları	100
Galvaniz sac kroşeler, çivili kroşeler, dübelller	102
Elektrik izolasyon bandı	102

Kapı zilleri ve trafoları	103
Yangın algılama ve ikaz sistemleri	104
ME-FAN aspiratörler	105
Mutlusan aspiratörler	106
Aydınlatmalı tavan vantilatörü	107
Exit - acil aydınlatma armatürleri	108
Led armatür ve armatür çeşitleri	109
Aplikler	111
Solar bahçe aplikleri	113
Bahçe armatürleri	114

pano ve endüstriyel ürün grubu

Promex delikli kanallar	118
Delikli kablo kanalları	120
Meksplus Abs Panolar	121
Promex Abs panoları ve otomat panoları	122
Abs pano aksesuarları	124
Sayaç Panoları	125
Pano prizleri	126
Higrostat ve termostatlar	127
Promex ve Eko fan tepe fanları	128
Filtreli fanlar ve pano ısıtıcıları	130
Promex Ray Klemens ve Aksesuarları	132
Alev yaymayan sıra klemensler	142
Geçmeli ve tırmıklı tip buat klemensler	143
Dağıtım üniteleri	144
UV Kablo bağları, Mutlusan kablo bağları	145
Yapışkan kroşeler, Kablo toplama & pano spiralleri	146
R-Meks plastik kablo rakorları	147
Promex plastik kablo rakoru	148
Polyamid spiral rakorları	149
Yüksükler	151
Baralar, raylar ve topraklama çubuğu	158
Skp çeşitleri	159
Cee norm fiş ve prizler	160
Sanayi tipi kauçuk fiş ve prizleri	163
Termoplastik buatlar ve kombinasyon kutuları	165
Kombinasyon panoları	167
Kumanda ve vinç kutuları	168
Butonlar ve potansiyometre	170
Ampermetre ve voltmetre	172

Mutlusan
CHARGEBOX



MUTLUSAN CHARGEBOX EV CHARGER
22 kW - 7 kW

Senin Enerjin
Senin Mutluluğun...



Kullanım Kılavuzu
İçin Lütfen Okutunuz



TAŞINABİLİR MUTLUSAN CHARGEBOX
EV CHARGER
3.5 kW

10.000
mAh

**ÇOK FONKSİYONLU
AKÜ TAKVİYE CİHAZI**



- Akıllı Akü Takviyesi
- Dijital Şişirme Pompası
- Acil Aydınlatma Işıkları
- Kamp Cihazları Şarjı
- Mobil Cihaz Şarjı

3.500
mAh

**TAŞINABİLİR
AKILLI ŞİŞİRME POMPASI**



- Dijital Şişirme Pompası
- Acil Aydınlatma Işıkları
- Kamp Cihazları Şarjı
- Mobil Cihaz Şarjı

Ürün Kodu	Ürün Adı	Adet	Fiyat (₺)
999 999 530001	ÇOK FONKSİYONLU AKÜ TAKVİYE CİHAZI	1	8.356,75

Ürün Kodu	Ürün Adı	Adet	Fiyat (₺)
999 999 530002	TAŞINABİLİR AKILLI ŞİŞİRME POMPASI	1	3.633,37

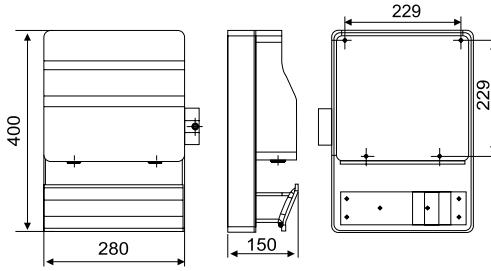

ARAÇ ŞARJ CİHAZLARI

Ürün Kodu	Ürün Adı	Kutu Adedi	Fiyat (\$)
22 kW ARAÇ ŞARJ CİHAZLARI - TRİFAZE			
001 191 022001 00 00	MUTLUSAN CHARGEBOX 22 kW EV CHARGER - SOKETLİ	1	1.800 \$
001 191 022002 00 00	MUTLUSAN CHARGEBOX 22 kW EV CHARGER - KABLOLU	1	2.050 \$
001 191 022011 00 00	MUTLUSAN CHARGEBOX 22 kW RFID EKLENTİLİ EV CHARGER - SOKETLİ	1	2.000 \$
001 191 022012 00 00	MUTLUSAN CHARGEBOX 22 kW RFID EKLENTİLİ EV CHARGE - KABLOLU	1	2.250 \$
001 191 000054 00 00	MUTLUSAN CHARGEBOX STAND	1	525 \$

Ürün Kodu	Ürün Adı	Kutu Adedi	Fiyat (\$)
7 kW ARAÇ ŞARJ CİHAZLARI - MONOFAZE			
001 191 070001 00 00	MUTLUSAN CHARGEBOX 7 kW EV CHARGER - SOKETLİ	1	1.550 \$
001 191 070002 00 00	MUTLUSAN CHARGEBOX 7 kW EV CHARGER - KABLOLU	1	1.750 \$
001 191 070011 00 00	MUTLUSAN CHARGEBOX 7 kW RFID EKLENTİLİ EV CHARGER - SOKETLİ	1	1.750 \$
001 191 070012 00 00	MUTLUSAN CHARGEBOX 7 kW RFID EKLENTİLİ EV CHARGER - KABLOLU	1	1.950 \$

Ürün Kodu	Ürün Adı	Kutu Adedi	Fiyat (\$)
3,5 kW ARAÇ ŞARJ CİHAZI - TAŞINABİLİR			
001 191 030000 00 00	MUTLUSAN CHARGEBOX 3.5 kW - TAŞINABİLİR	1	850 \$

Ürün Kodu	Ürün Adı	Kutu Adedi	Fiyat (\$)
-----------	----------	------------	------------

ŞARJ CİHAZI KABLOLU FİŞLER (5 MT)

999 983 000010	MUTLUSAN CHARGEBOX 7 kW ÇİFT TARAFLI KABLOLU FİŞ	1	790 \$
999 983 000012	MUTLUSAN CHARGEBOX 22 kW ÇİFT TARAFLI KABLOLU FİŞ	1	940 \$
999 983 000064	MUTLUSAN CHARGEBOX 7 kW ÇİFT TARAFLI KABLOLU FİŞ - SİRALLİ	1	640 \$
999 983 000066	MUTLUSAN CHARGEBOX 22 kW ÇİFT TARAFLI KABLOLU FİŞ - SİRALLİ	1	790 \$

Ürün Kodu	Ürün Adı	Kutu Adedi	Fiyat (\$)
-----------	----------	------------	------------

RFID KART

999 983 000050	MUTLUSAN CHARGEBOX RFID KART	1	20,65 \$
----------------	------------------------------	---	----------



ŞALT GRUBU



B - C - D TİPİ OTOMATİK SİGORTALAR

- Hata korumalı terminal bloklarına sahip terminal ve kontak konumu gösteren pencere ile daha yüksek güvenlik.
- Manyetik üflemlerle ark seperatörü açma - kapatma anında oluşan arkı güvenli bir şekilde söndürer.
- Kalıp ve fonksiyon parçalarının tümü, yüksek alev geciktirici ve yüksek sıcaklık dayanımı, aynı zamanda darbeye dayanıklı PA66 polyamid malzemeden yapılmıştır.



960°C'ye kadar alev iletmez. Kaliteli polyamid 66 malzeme

Renkli kontak konumu göstergesi, cihazın durumunun ve yalıtım fonksiyonunun görsel olarak gösterilmesini sağlar.

B/C/D tipi seçenekleriyle

6-10 kA kesme kapasitesi

Kurma kolunun pozisyonu ON-I konumunda akıma açık, O-OFF konumunda akıma kapalıdır.

Farklı amper değerlerinde üretilmiş olan bu otomatik sigortalar ya da diğer adıyla minyatür devre kesiciler, elektrik tesisatını ve sistemi aşırı akım ve kısa devrelere karşı korumak amacıyla tasarlanmış koruma ve anahtarlama devre elemanlarıdır. Devreden geçen akım, sigortaların nominal akımlarının belirli bir seviye üstüne çıkması durumunda ya da devrede bir kısa devre meydana gelmesi durumunda otomatik sigortalar elektrik akımını keserek kendinden sonraki sistemi korumaya almaktadır.



1 Kutup



2 Kutup



3 Kutup



4 Kutup

OTOMATİK SİGORTA REFERANS KODU SEÇİMİ

MTS	Kiloamper (kA)	Kutup Sayısı	Amper (A)	Tip (Eğri)
Otomatik Sigorta Seri Kodu	06/10	1/2/3/4	XXX 1A...63A	B/C/D

ÖRNEK REFERANS SEÇİMİ :
MTS06-2050C (6kA, 2 Kutup, 50A, C Tipi)

XXX: 001 (1A Otomatik Sigorta)
XXX: 010 (10A Otomatik Sigorta)
XXX: 100 (100A Otomatik Sigorta)



B - C - D TİPİ OTOMATİK SİGORTALAR - 6kA (MCB)

MTS-6 SERİSİ



Kutup Sayısı	In (A) Anma Akımı	B Tipi Ürün Kodu	C Tipi Ürün Kodu	D Tipi Ürün Kodu	Kutu Adedi	Koli Adedi	Fiyat (\$)
1P	1A	MTS06-1001B	MTS06-1001C	MTS06-1001D	12	240	6,15 \$
	2A	MTS06-1002B	MTS06-1002C	MTS06-1002D	12	240	6,15 \$
	3A	MTS06-1003B	MTS06-1003C	MTS06-1003D	12	240	6,15 \$
	4A	MTS06-1004B	MTS06-1004C	MTS06-1004D	12	240	6,15 \$
	5A	MTS06-1005B	MTS06-1005C	MTS06-1005D	12	240	6,15 \$
	6A	MTS06-1006B	MTS06-1006C	MTS06-1006D	12	240	5,08 \$
	10A	MTS06-1010B	MTS06-1010C	MTS06-1010D	12	240	4,58 \$
	16A	MTS06-1016B	MTS06-1016C	MTS06-1016D	12	240	4,58 \$
	20A	MTS06-1020B	MTS06-1020C	MTS06-1020D	12	240	4,58 \$
	25A	MTS06-1025B	MTS06-1025C	MTS06-1025D	12	240	4,58 \$
	32A	MTS06-1032B	MTS06-1032C	MTS06-1032D	12	240	5,14 \$
	40A	MTS06-1040B	MTS06-1040C	MTS06-1040D	12	240	5,77 \$
	50A	MTS06-1050B	MTS06-1050C	MTS06-1050D	12	240	6,37 \$
63A	MTS06-1063B	MTS06-1063C	MTS06-1063D	12	240	6,58 \$	



2P	1A	MTS06-2001B	MTS06-2001C	MTS06-2001D	6	120	11,54 \$
	2A	MTS06-2002B	MTS06-2002C	MTS06-2002D	6	120	11,54 \$
	3A	MTS06-2003B	MTS06-2003C	MTS06-2003D	6	120	11,54 \$
	4A	MTS06-2004B	MTS06-2004C	MTS06-2004D	6	120	11,54 \$
	5A	MTS06-2005B	MTS06-2005C	MTS06-2005D	6	120	11,54 \$
	6A	MTS06-2006B	MTS06-2006C	MTS06-2006D	6	120	9,62 \$
	10A	MTS06-2010B	MTS06-2010C	MTS06-2010D	6	120	9,62 \$
	16A	MTS06-2016B	MTS06-2016C	MTS06-2016D	6	120	9,62 \$
	20A	MTS06-2020B	MTS06-2020C	MTS06-2020D	6	120	9,62 \$
	25A	MTS06-2025B	MTS06-2025C	MTS06-2025D	6	120	9,62 \$
	32A	MTS06-2032B	MTS06-2032C	MTS06-2032D	6	120	13,45 \$
	40A	MTS06-2040B	MTS06-2040C	MTS06-2040D	6	120	13,45 \$
	50A	MTS06-2050B	MTS06-2050C	MTS06-2050D	6	120	14,87 \$
63A	MTS06-2063B	MTS06-2063C	MTS06-2063D	6	120	15,30 \$	



3P	1A	MTS06-3001B	MTS06-3001C	MTS06-3001D	4	80	18,99 \$
	2A	MTS06-3002B	MTS06-3002C	MTS06-3002D	4	80	18,99 \$
	3A	MTS06-3003B	MTS06-3003C	MTS06-3003D	4	80	18,99 \$
	4A	MTS06-3004B	MTS06-3004C	MTS06-3004D	4	80	18,99 \$
	5A	MTS06-3005B	MTS06-3005C	MTS06-3005D	4	80	19,00 \$
	6A	MTS06-3006B	MTS06-3006C	MTS06-3006D	4	80	15,73 \$
	10A	MTS06-3010B	MTS06-3010C	MTS06-3010D	4	80	15,74 \$
	16A	MTS06-3016B	MTS06-3016C	MTS06-3016D	4	80	15,74 \$
	20A	MTS06-3020B	MTS06-3020C	MTS06-3020D	4	80	15,74 \$
	25A	MTS06-3025B	MTS06-3025C	MTS06-3025D	4	80	15,96 \$
	32A	MTS06-3032B	MTS06-3032C	MTS06-3032D	4	80	18,46 \$
	40A	MTS06-3040B	MTS06-3040C	MTS06-3040D	4	80	18,46 \$
	50A	MTS06-3050B	MTS06-3050C	MTS06-3050D	4	80	18,85 \$
63A	MTS06-3063B	MTS06-3063C	MTS06-3063D	4	80	21,15 \$	



4P	1A	MTS06-4001B	MTS06-4001C	MTS06-4001D	3	60	27,01 \$
	2A	MTS06-4002B	MTS06-4002C	MTS06-4002D	3	60	27,01 \$
	3A	MTS06-4003B	MTS06-4003C	MTS06-4003D	3	60	27,01 \$
	4A	MTS06-4004B	MTS06-4004C	MTS06-4004D	3	60	27,01 \$
	5A	MTS06-4005B	MTS06-4005C	MTS06-4005D	3	60	28,46 \$
	6A	MTS06-4006B	MTS06-4006C	MTS06-4006D	3	60	25,17 \$
	10A	MTS06-4010B	MTS06-4010C	MTS06-4010D	3	60	22,46 \$
	16A	MTS06-4016B	MTS06-4016C	MTS06-4016D	3	60	22,46 \$
	20A	MTS06-4020B	MTS06-4020C	MTS06-4020D	3	60	22,46 \$
	25A	MTS06-4025B	MTS06-4025C	MTS06-4025D	3	60	22,46 \$
	32A	MTS06-4032B	MTS06-4032C	MTS06-4032D	3	60	25,93 \$
	40A	MTS06-4040B	MTS06-4040C	MTS06-4040D	3	60	27,01 \$
	50A	MTS06-4050B	MTS06-4050C	MTS06-4050D	3	60	29,07 \$
63A	MTS06-4063B	MTS06-4063C	MTS06-4063D	3	60	31,79 \$	

B - C TİPİ OTOMATİK SİGORTALAR - 10KA (MCB)



MTS-10 SERİSİ

Kutup Sayısı	In (A) Anma Akımı	B Tipi Ürün Kodu	C Tipi Ürün Kodu	Kutu Adedi	Koli Adedi	Fiyat (\$)
1P	1A	MTS10-1001B	MTS10-1001C	12	240	10,58 \$
	2A	MTS10-1002B	MTS10-1002C	12	240	10,58 \$
	3A	MTS10-1003B	MTS10-1003C	12	240	10,58 \$
	4A	MTS10-1004B	MTS10-1004C	12	240	10,58 \$
	5A	MTS10-1005B	MTS10-1005C	12	240	10,58 \$
	6A	MTS10-1006B	MTS10-1006C	12	240	8,99 \$
	10A	MTS10-1010B	MTS10-1010C	12	240	8,08 \$
	16A	MTS10-1016B	MTS10-1016C	12	240	8,08 \$
	20A	MTS10-1020B	MTS10-1020C	12	240	8,08 \$
	25A	MTS10-1025B	MTS10-1025C	12	240	8,08 \$
	32A	MTS10-1032B	MTS10-1032C	12	240	8,65 \$
	40A	MTS10-1040B	MTS10-1040C	12	240	9,98 \$
	50A	MTS10-1050B	MTS10-1050C	12	240	10,58 \$
	63A	MTS10-1063B	MTS10-1063C	12	240	12,12 \$
	80A	MTS10-1080B	MTS10-1080C	12	240	21,24 \$
100A	MTS10-1100B	MTS10-1100C	12	240	21,97 \$	
125A	MTS10-1125B	MTS10-1125C	12	240	25,19 \$	
2P	1A	MTS10-2001B	MTS10-2001C	6	120	25,00 \$
	2A	MTS10-2002B	MTS10-2002C	6	120	25,00 \$
	3A	MTS10-2003B	MTS10-2003C	6	120	25,00 \$
	4A	MTS10-2004B	MTS10-2004C	6	120	25,00 \$
	5A	MTS10-2005B	MTS10-2005C	6	120	25,00 \$
	6A	MTS10-2006B	MTS10-2006C	6	120	24,23 \$
	10A	MTS10-2010B	MTS10-2010C	6	120	22,78 \$
	16A	MTS10-2016B	MTS10-2016C	6	120	22,78 \$
	20A	MTS10-2020B	MTS10-2020C	6	120	22,78 \$
	25A	MTS10-2025B	MTS10-2025C	6	120	22,78 \$
	32A	MTS10-2032B	MTS10-2032C	6	120	26,35 \$
	40A	MTS10-2040B	MTS10-2040C	6	120	27,34 \$
	50A	MTS10-2050B	MTS10-2050C	6	120	28,08 \$
	63A	MTS10-2063B	MTS10-2063C	6	120	28,85 \$
	80A	MTS10-2080B	MTS10-2080C	6	120	39,15 \$
100A	MTS10-2100B	MTS10-2100C	6	120	42,25 \$	
125A	MTS10-2125B	MTS10-2125C	6	120	46,93 \$	
3P	1A	MTS10-3001B	MTS10-3001C	4	80	36,54 \$
	2A	MTS10-3002B	MTS10-3002C	4	80	36,54 \$
	3A	MTS10-3003B	MTS10-3003C	4	80	36,54 \$
	4A	MTS10-3004B	MTS10-3004C	4	80	36,54 \$
	5A	MTS10-3005B	MTS10-3005C	4	80	36,54 \$
	6A	MTS10-3006B	MTS10-3006C	4	80	29,72 \$
	10A	MTS10-3010B	MTS10-3010C	4	80	27,55 \$
	16A	MTS10-3016B	MTS10-3016C	4	80	27,55 \$
	20A	MTS10-3020B	MTS10-3020C	4	80	27,55 \$
	25A	MTS10-3025B	MTS10-3025C	4	80	28,85 \$
	32A	MTS10-3032B	MTS10-3032C	4	80	29,42 \$
	40A	MTS10-3040B	MTS10-3040C	4	80	31,54 \$
	50A	MTS10-3050B	MTS10-3050C	4	80	35,58 \$
	63A	MTS10-3063B	MTS10-3063C	4	80	40,38 \$
	80A	MTS10-3080B	MTS10-3080C	6	120	74,83 \$
100A	MTS10-3100B	MTS10-3100C	6	120	77,08 \$	
125A	MTS10-3125B	MTS10-3125C	6	120	83,97 \$	
4P	1A	MTS10-4001B	MTS10-4001C	3	60	51,10 \$
	2A	MTS10-4002B	MTS10-4002C	3	60	51,10 \$
	3A	MTS10-4003B	MTS10-4003C	3	60	51,10 \$
	4A	MTS10-4004B	MTS10-4004C	3	60	51,10 \$
	5A	MTS10-4005B	MTS10-4005C	3	60	51,12 \$
	6A	MTS10-4006B	MTS10-4006C	3	60	41,33 \$
	10A	MTS10-4010B	MTS10-4010C	3	60	38,22 \$
	16A	MTS10-4016B	MTS10-4016C	3	60	38,22 \$
	20A	MTS10-4020B	MTS10-4020C	3	60	38,22 \$
	25A	MTS10-4025B	MTS10-4025C	3	60	38,22 \$
	32A	MTS10-4032B	MTS10-4032C	3	60	38,33 \$
	40A	MTS10-4040B	MTS10-4040C	3	60	38,33 \$
	50A	MTS10-4050B	MTS10-4050C	3	60	50,00 \$
	63A	MTS10-4063B	MTS10-4063C	3	60	53,85 \$
	80A	MTS10-4080B	MTS10-4080C	4	80	102,04 \$
100A	MTS10-4100B	MTS10-4100C	4	80	105,52 \$	
125A	MTS10-4125B	MTS10-4125C	4	80	118,46 \$	





B - C TİPİ OTOMATİK SİGORTALAR - 10kA (MCB) - GENİŞ KASA

MTH SERİSİ

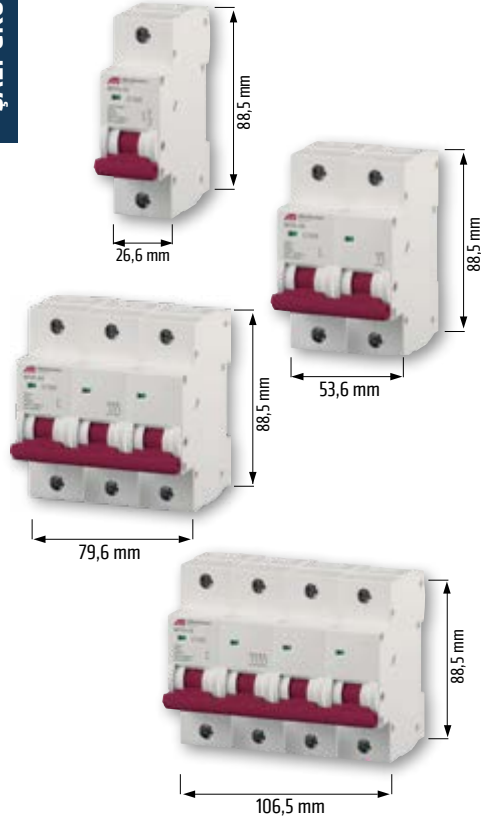

Kutup Sayısı	In (A) Anma Akımı	B Tipi Ürün Kodu	C Tipi Ürün Kodu	Kutu Adedi	Koli Adedi	Fiyat (\$)
1P	80A	MTH10-1080B	MTH10-1080C	12	120	23,85 \$
	100A	MTH10-1100B	MTH10-1100C	12	120	26,92 \$
	125A	MTH10-1125B	MTH10-1125C	12	120	28,85 \$
2P	80A	MTH10-2080B	MTH10-2080C	6	60	44,23 \$
	100A	MTH10-2100B	MTH10-2100C	6	60	46,15 \$
	125A	MTH10-2125B	MTH10-2125C	6	60	53,85 \$
3P	80A	MTH10-3080B	MTH10-3080C	4	40	76,15 \$
	100A	MTH10-3100B	MTH10-3100C	4	40	80,00 \$
	125A	MTH10-3125B	MTH10-3125C	4	40	88,46 \$
4P	80A	MTH10-4080B	MTH10-4080C	3	30	98,08 \$
	100A	MTH10-4100B	MTH10-4100C	3	30	103,85 \$
	125A	MTH10-4125B	MTH10-4125C	3	30	130,77 \$

OTOMATİK SİGORTA AKSESUARLARI



YARDIMCI KONTAK

EMNİYET KİLİT APARATI

Ürün Kodu	Ürün Adı	Kutu Adedi	Fiyat (\$)
MTSAUX-AC12	Yardımcı KONTAK 1NO+1NC (MTS06 ve MTS10 için)	1	11,92 \$
MTSAUX-230	Açtırma Bobini 230V AC (MTS06 ve MTS10 için)	1	17,69 \$
MTSAUX-063	Alarm KONTAK (MTS06 ve MTS10 için)	1	11,92 \$
MTSACC-SL1	Emniyet Kilit Aparatı (MTS serileri için)	1	30,77 \$
MTSACC-SL2	Emniyet Kilit Aparatı (MRC ve MTH (Geniş kasa) serileri için)	1	30,77 \$



FAZ+NÖTR SİGORTALAR - 4,5kA (DPN+MCB)

MTS04-LN SERİSİ



Kutup Sayısı	In (A) Anma Akımı	Ürün Kodu	Kutu Adedi	Koli Adedi	Fiyat (\$)
1P+N	6A	MTS04-106CN	12	240	7,62 \$
	10A	MTS04-110CN	12	240	7,62 \$
	16A	MTS04-116CN	12	240	7,62 \$
	20A	MTS04-120CN	12	240	7,62 \$
	25A	MTS04-125CN	12	240	7,62 \$
	32A	MTS04-132CN	12	240	8,38 \$
	40A	MTS04-140CN	12	240	8,38 \$

MTS	Kiloamper (kA)	Kutup Sayısı	Amper (A)	Tip (Eğri)	Nötr
Faz + Nötr Seri Kodu	04	1	XX 6A...40A	C	N

HANGİ KAÇAK AKIM KORUMA SEÇİLMELİ?

Uyumlu koruma, güvenli enerji anlamına gelir.

Her yükün ve cihazın, devreyi koruyan kaçak akım koruma tipiyle uyumlu olduğundan emin olunmalıdır.

AC TİPİ



Alternatif kaçak akım (AC)

Rezistif yükler, klasik aydınlatma sistemleri ve elektrikli ısıtıcılarla tam uyumlu; asansör bulunmayan klasik aydınlatmalı konutlar için ideal tercihtir.



A TİPİ



Alternatif kaçak akım (AC)
Darbeli DC kaçak akım

Led sürücüler, dimmerler, yürüyen merdivenler, asansörler için; asansörlü ve led aydınlatmalı konutlarda en iyi performansı sunar.



B TİPİ



Alternatif kaçak akım (AC)
Darbeli ve doğru kaçak akım

Elektrikli araç (EV) şarj istasyonlarında, güneş paneli inverterleri, UPS / kesintisiz güç kaynakları, MR cihazları için güvenilir bir çözümdür.



KAÇAK AKIM'DAN KORUNMA

DOĞRU
SEÇİM
GÜVENLİ HAYAT



10 mA - 30 mA Hayat Koruması

10 mA - 30 mA Kaçak akım eşiğine sahip bir artık akım cihazı (RCD), insan hayatını korumak ve elektrik çarpmalarını önlemek için kullanılır.

100 mA - 300 mA Yangın Koruması

Olası yalıtım hatalarından kaynaklanan yangın riskini önlemek için, 100 mA - 300 mA kaçak akım eşiğine sahip bir RCD kullanılır.

Kaçak Akım Seviyesi	Koruma Seviyesi	Hayat Güvenliği	Yangın Güvenliği	Kullanım Alanları
■ 10 mA	❤️ Hayat Koruması	✓✓✓✓✓	✓	• Banyo / Duş • Sağlık Alanları • Çocuk Alanları
■ 30 mA	❤️ Hayat Koruması	✓✓✓✓	✓✓	• Konutlar • Priz Devreleri • Ofisler
■ 100 mA	🔥 Yangın Koruması	✓✓	✓✓✓✓	• Endüstriyel Tesisler • Atölyeler • Tali Panolar
■ 300 mA	🔥 Yangın Koruması	✗	✓✓✓✓✓	• Ana Panolar • Büyük Tesisler • AVM / Fabrika Girişi

MRC	Kiloamper (kA)	Kutup Sayısı	Miliamper (mA)	Amper (A)	Tip
Kaçak Akım Koruma Seri Kodu	06/10	2/4	030/300	XXX 1A...100A	A / A tipi / AC tipi

KAÇAK AKIM DEVRE KORUMA 6kA / AC TİPİ (RCCB)



MRC-2 / MRC-4 SERİSİ

Kutup Sayısı	In (A) Anma Akımı	mA	AC Tipi Ürün Kodu	Kutu Adedi	Koli Adedi	Fiyat (\$)
2P	16A	10 mA	MRC06-201016	1	100	36,93 \$
	25A		MRC06-201025	1	100	37,66 \$
	16A		30 mA	MRC06-203016	1	100
	20A	MRC06-203020		1	100	33,08 \$
	25A	MRC06-203025		1	100	33,08 \$
	32A	MRC06-203032		1	100	33,08 \$
	40A	MRC06-203040		1	100	33,08 \$
	50A	MRC06-203050		1	100	34,62 \$
	63A	MRC06-203063		1	100	36,45 \$
	80A	MRC06-203080		1	100	49,46 \$
	100A	MRC06-2030100		1	100	59,66 \$
	16A	100 mA	MRC06-210016	1	100	33,74 \$
	20A		MRC06-210020	1	100	33,74 \$
	25A		MRC06-210025	1	100	33,74 \$
	32A		MRC06-210032	1	100	33,74 \$
	40A		MRC06-210040	1	100	33,74 \$
	50A		MRC06-210050	1	100	33,74 \$
	63A		MRC06-210063	1	100	33,74 \$
	80A		MRC06-210080	1	100	48,92 \$
	100A		MRC06-2100100	1	100	54,59 \$
	16A	300 mA	MRC06-230016	1	100	33,74 \$
	20A		MRC06-230020	1	100	33,74 \$
	25A		MRC06-230025	1	100	31,92 \$
	32A		MRC06-230032	1	100	31,92 \$
	40A		MRC06-230040	1	100	31,92 \$
	50A		MRC06-230050	1	100	31,92 \$
	63A		MRC06-230063	1	100	36,24 \$
	80A		MRC06-230080	1	100	48,92 \$
	100A		MRC06-2300100	1	100	54,57 \$
	4P	16A	30 mA	MRC06-403016	1	50
20A		MRC06-403020		1	50	48,08 \$
25A		MRC06-403025		1	50	48,08 \$
32A		MRC06-403032		1	50	48,08 \$
40A		MRC06-403040		1	50	48,08 \$
50A		MRC06-403050		1	50	49,56 \$
63A		MRC06-403063		1	50	50,77 \$
80A		MRC06-403080		1	50	70,22 \$
100A		MRC06-4030100		1	50	70,22 \$
16A		100 mA	MRC06-410016	1	50	49,56 \$
20A			MRC06-410020	1	50	49,56 \$
25A			MRC06-410025	1	50	49,56 \$
32A			MRC06-410032	1	50	49,56 \$
40A			MRC06-410040	1	50	49,56 \$
50A			MRC06-410050	1	50	49,56 \$
63A			MRC06-410063	1	50	49,56 \$
80A			MRC06-410080	1	50	64,56 \$
100A			MRC06-4100100	1	50	69,27 \$
16A		300 mA	MRC06-430016	1	50	49,56 \$
20A			MRC06-430020	1	50	49,56 \$
25A			MRC06-430025	1	50	49,58 \$
32A			MRC06-430032	1	50	49,58 \$
40A			MRC06-430040	1	50	49,58 \$
50A			MRC06-430050	1	50	49,58 \$
63A			MRC06-430063	1	50	50,00 \$
80A			MRC06-430080	1	50	70,72 \$
100A			MRC06-4300100	1	50	79,52 \$



CE KAÇAK AKIM DEVRE KORUMA 10kA / AC TİPİ (RCCB)

MRC-2-10 / MRC-4 -10 SERİSİ



Kutup Sayısı	In (A) Anma Akımı	mA	AC Tipi Ürün Kodu	Kutu Adedi	Koli Adedi	Fiyat (\$)	
2P	16A	30 mA	MRC10-203016	1	100	39,62 \$	
	20A		MRC10-203020	1	100	39,62 \$	
	25A		MRC10-203025	1	100	39,62 \$	
	32A		MRC10-203032	1	100	39,62 \$	
	40A		MRC10-203040	1	100	39,62 \$	
	50A		MRC10-203050	1	100	42,31 \$	
	63A		MRC10-203063	1	100	42,31 \$	
	80A		MRC10-203080	1	100	64,69 \$	
	100A		MRC10-2030100	1	100	64,69 \$	
	125A		MRC10-2030125	1	50	76,92 \$	
	16A	300 mA	MRC10-230016	1	100	39,62 \$	
	20A		MRC10-230020	1	100	39,62 \$	
	25A		MRC10-230025	1	100	39,62 \$	
	32A		MRC10-230032	1	100	39,62 \$	
	40A		MRC10-230040	1	100	39,62 \$	
	50A		MRC10-230050	1	100	42,31 \$	
	63A		MRC10-230063	1	100	42,31 \$	
	80A		MRC10-230080	1	100	64,69 \$	
	100A		MRC10-2300100	1	100	64,69 \$	
	125A		MRC10-2300125	1	50	76,92 \$	
	4P	16A	30 mA	MRC10-403016	1	50	67,31 \$
		20A		MRC10-403020	1	50	67,31 \$
		25A		MRC10-403025	1	50	67,31 \$
		32A		MRC10-403032	1	50	67,31 \$
40A		MRC10-403040		1	50	67,31 \$	
50A		MRC10-403050		1	50	67,31 \$	
63A		MRC10-403063		1	50	67,31 \$	
80A		MRC10-403080		1	50	88,87 \$	
100A		MRC10-4030100		1	50	88,87 \$	
125A		MRC10-4030125		1	50	100,00 \$	
16A		300 mA	MRC10-430016	1	50	67,34 \$	
20A			MRC10-430020	1	50	67,34 \$	
25A			MRC10-430025	1	50	67,34 \$	
32A			MRC10-430032	1	50	67,34 \$	
40A			MRC10-430040	1	50	67,34 \$	
50A			MRC10-430050	1	50	67,34 \$	
63A			MRC10-430063	1	50	67,34 \$	
80A			MRC10-430080	1	50	88,87 \$	
100A			MRC10-4300100	1	50	88,87 \$	
125A			MRC10-4300125	1	50	100,00 \$	

KAÇAK AKIM DEVRE KORUMA 6kA / A TİPİ (RCCB)

CE

MRC-2 / MRC-4 SERİSİ

Kutup Sayısı	In (A) Anma Akımı	mA	A Tipi Ürün Kodu	Kutu Adedi	Koli Adedi	Fiyat (\$)
2P	16A	30 mA	MRC06-203016A	1	100	50,48 \$
	20A		MRC06-203020A	1	100	50,48 \$
	25A		MRC06-203025A	1	100	50,48 \$
	32A		MRC06-203032A	1	100	50,48 \$
	40A		MRC06-203040A	1	100	50,48 \$
	50A		MRC06-203050A	1	100	50,48 \$
	63A		MRC06-203063A	1	100	50,48 \$
	80A		MRC06-203080A	1	100	86,59 \$
	100A		MRC06-2030100A	1	100	86,59 \$
	16A	300 mA	MRC06-230016A	1	100	50,48 \$
	20A		MRC06-230020A	1	100	50,48 \$
	25A		MRC06-230025A	1	100	50,48 \$
	32A		MRC06-230032A	1	100	50,48 \$
	40A		MRC06-230040A	1	100	50,48 \$
	50A		MRC06-230050A	1	100	50,48 \$
	63A		MRC06-230063A	1	100	50,48 \$
	80A		MRC06-230080A	1	100	65,84 \$
	100A		MRC06-2300100A	1	100	65,84 \$
4P	16A	30 mA	MRC06-403016A	1	50	64,46 \$
	20A		MRC06-403020A	1	50	64,46 \$
	25A		MRC06-403025A	1	50	64,46 \$
	32A		MRC06-403032A	1	50	64,46 \$
	40A		MRC06-403040A	1	50	64,46 \$
	50A		MRC06-403050A	1	50	64,46 \$
	63A		MRC06-403063A	1	50	64,46 \$
	80A		MRC06-403080A	1	50	102,87 \$
	100A		MRC06-4030100A	1	50	102,87 \$
	16A	300 mA	MRC06-430016A	1	50	64,46 \$
	20A		MRC06-430020A	1	50	64,46 \$
	25A		MRC06-430025A	1	50	64,46 \$
	32A		MRC06-430032A	1	50	64,46 \$
	40A		MRC06-430040A	1	50	64,46 \$
	50A		MRC06-430050A	1	50	64,46 \$
	63A		MRC06-430063A	1	50	64,46 \$
	80A		MRC06-430080A	1	50	88,46 \$
	100A		MRC06-4300100A	1	50	88,46 \$



CE KAÇAK AKIM DEVRE KORUMA 10kA / A TİPİ (RCCB)

MRC-2-10 / MRC-4 -10 SERİSİ



Kutup Sayısı	In (A) Anma Akımı	mA	A Tipi Ürün Kodu	Kutu Adedi	Koli Adedi	Fiyat (\$)
2P	16A	30 mA	MRC10-203016A	1	100	58,52 \$
	20A		MRC10-203020A	1	100	58,52 \$
	25A		MRC10-203025A	1	100	58,52 \$
	32A		MRC10-203032A	1	100	58,52 \$
	40A		MRC10-203040A	1	100	58,52 \$
	50A		MRC10-203050A	1	100	58,52 \$
	63A		MRC10-203063A	1	100	58,52 \$
	80A		MRC10-203080A	1	100	94,55 \$
	100A		MRC10-2030100A	1	100	94,55 \$
	125A		MRC10-2030125A	1	100	103,85 \$
	16A	300 mA	MRC10-230016A	1	100	58,52 \$
	20A		MRC10-230020A	1	100	58,52 \$
	25A		MRC10-230025A	1	100	58,52 \$
	32A		MRC10-230032A	1	100	58,52 \$
	40A		MRC10-230040A	1	100	58,52 \$
	50A		MRC10-230050A	1	100	58,52 \$
	63A		MRC10-230063A	1	100	58,52 \$
	80A		MRC10-230080A	1	100	94,54 \$
	100A		MRC10-2300100A	1	100	94,54 \$
	125A		MRC10-2300125A	1	100	103,85 \$
4P	16A	30 mA	MRC10-403016A	1	50	80,10 \$
	20A		MRC10-403020A	1	50	80,10 \$
	25A		MRC10-403025A	1	50	80,10 \$
	32A		MRC10-403032A	1	50	80,10 \$
	40A		MRC10-403040A	1	50	80,10 \$
	50A		MRC10-403050A	1	50	80,10 \$
	63A		MRC10-403063A	1	50	80,10 \$
	80A		MRC10-403080A	1	50	118,78 \$
	100A		MRC10-4030100A	1	50	118,78 \$
	125A		MRC10-4030125A	1	50	126,92 \$
	16A	300 mA	MRC10-430016A	1	50	80,10 \$
	20A		MRC10-430020A	1	50	80,10 \$
	25A		MRC10-430025A	1	50	80,10 \$
	32A		MRC10-430032A	1	50	80,10 \$
	40A		MRC10-430040A	1	50	80,10 \$
	50A		MRC10-430050A	1	50	80,10 \$
	63A		MRC10-430063A	1	50	80,10 \$
	80A		MRC10-430080A	1	50	118,77 \$
	100A		MRC10-4300100A	1	50	118,77 \$
	125A		MRC10-4300125A	1	50	126,92 \$



KAÇAK AKIM DEVRE KORUMA - 10kA / B TİPİ (RCCB)

Kutup Sayısı	In (A) Anma Akımı	mA	Ürün Kodu	Kutu Adedi	Koli Adedi	Fiyat (\$)
2P	25A	30 mA	MRC10-203025B	1	100	187,09 \$
	40A		MRC10-203040B	1	100	187,09 \$
	63A		MRC10-203063B	1	100	187,09 \$
	25A	300 mA	MRC10-230025B	1	100	187,09 \$
	40A		MRC10-230040B	1	100	187,09 \$
	63A		MRC10-230063B	1	100	187,09 \$
4P	25A	30 mA	MRC10-403025B	1	50	320,78 \$
	40A		MRC10-403040B	1	50	320,78 \$
	63A		MRC10-403063B	1	50	320,78 \$
	25A	300 mA	MRC10-430025B	1	50	320,78 \$
	40A		MRC10-430040B	1	50	320,78 \$
	63A		MRC10-430063B	1	50	320,78 \$



MRC-2B / MRC-4B SERİSİ



KAÇAK AKIM DEVRE KORUMA - GECİKMELİ - 6kA

Kutup Sayısı	In (A) Anma Akımı	mA	Ürün Tipi	Kutu Adedi	Koli Adedi	Fiyat (\$)	
2P	25A	30 mA	AC Tipi	MRC06-203025G	1	100	64,36 \$
	40A			MRC06-203040G	1	100	64,36 \$
	63A			MRC06-203063G	1	100	64,36 \$
	80A			MRC06-203080G	1	100	96,11 \$
	100A			MRC06-2030100G	1	100	96,12 \$
	25A	30 mA	A Tipi	MRC06-203025AG	1	100	79,08 \$
	40A			MRC06-203040AG	1	100	79,08 \$
	63A			MRC06-203063AG	1	100	79,08 \$
	80A			MRC06-203080AG	1	100	103,95 \$
	100A			MRC06-2030100AG	1	100	103,96 \$
	25A	300 mA	AC Tipi	MRC06-230025G	1	100	64,36 \$
	40A			MRC06-230040G	1	100	64,36 \$
	63A			MRC06-230063G	1	100	64,36 \$
	80A			MRC06-230080G	1	100	71,76 \$
	100A			MRC06-2300100G	1	100	71,76 \$
	25A	300 mA	A Tipi	MRC06-230025AG	1	100	79,08 \$
	40A			MRC06-230040AG	1	100	79,08 \$
	63A			MRC06-230063AG	1	100	79,08 \$
	80A			MRC06-230080AG	1	100	86,39 \$
	100A			MRC06-2300100AG	1	100	86,39 \$
4P	25A	30 mA	AC Tipi	MRC06-403025G	1	50	81,86 \$
	40A			MRC06-403040G	1	50	81,86 \$
	63A			MRC06-403063G	1	50	81,86 \$
	80A			MRC06-403080G	1	50	94,89 \$
	100A			MRC06-4030100G	1	50	94,89 \$
	25A	30 mA	A Tipi	MRC06-403025AG	1	50	96,84 \$
	40A			MRC06-403040AG	1	50	96,84 \$
	63A			MRC06-403063AG	1	50	96,84 \$
	80A			MRC06-403080AG	1	50	122,28 \$
	100A			MRC06-4030100AG	1	50	122,28 \$
	25A	300 mA	AC Tipi	MRC06-430025G	1	50	81,86 \$
	40A			MRC06-430040G	1	50	81,86 \$
	63A			MRC06-430063G	1	50	81,86 \$
	80A			MRC06-430080G	1	50	89,26 \$
	100A			MRC06-4300100G	1	50	89,26 \$
	25A	300 mA	A Tipi	MRC06-430025AG	1	50	96,84 \$
	40A			MRC06-430040AG	1	50	96,84 \$
	63A			MRC06-430063AG	1	50	96,84 \$
	80A			MRC06-430080AG	1	50	104,24 \$
	100A			MRC06-4300100AG	1	50	104,24 \$



MRC-2G / MRC-4G SERİSİ

* Gecikmeli tip kaçak akım devre korumalar, seçicilik sağlayarak alt devrelerin önce açmasını mümkün kılar.



KAÇAK AKIM TEKRAR KAPATMA ÜNİTESİ - RECLOSER

Ürün Kodu	Ürün Adı	Kutu Adedi	Koli Adedi	Fiyat (\$)
MRC06-RC300	Kaçak Akım Tekrar Kapatma Ünitesi	1	50	175,84 \$



ARK HATASI ALGILAMA RÖLESİ (AFDD)

MAFD SERİSİ



Kutup Sayısı	In (A) Anma Akımı	mA	Tip	Ürün Kodu	Kutu Adedi	Koli Adedi	Fiyat (\$)
2P	6A	30 mA	RCCB+AFDD-32	MAFDR1C06-203006	1	100	211,05 \$
	10A			MAFDR1C06-203010	1	100	211,05 \$
	16A			MAFDR1C06-203016	1	100	211,05 \$
	20A			MAFDR1C06-203020	1	100	211,05 \$
	25A			MAFDR1C06-203025	1	100	211,05 \$
	32A			MAFDR1C06-203032	1	100	211,05 \$
	6A	30 mA	RCBO+AFDD-32	MAFDR1C06-203006	1	100	225,13 \$
	10A			MAFDR1C06-203010	1	100	225,13 \$
	16A			MAFDR1C06-203016	1	100	225,13 \$
	20A			MAFDR1C06-203025	1	100	225,13 \$
	25A			MAFDR1C06-203030	1	100	225,13 \$
	32A			MAFDR1C06-203032	1	100	225,13 \$
	6A	30 mA	MCB + AFDD-32	MAFDT1S06-2006	1	100	196,96 \$
	10A			MAFDT1S06-2010	1	100	196,96 \$
	16A			MAFDT1S06-2016	1	100	196,96 \$
	20A			MAFDT1S06-2020	1	100	196,96 \$
	25A			MAFDT1S06-2025	1	100	196,96 \$
	32A			MAFDT1S06-2032	1	100	196,96 \$
2P	6A	30 mA	RCCB+AFDD-63	MAFDR2C06-203006	1	50	184,86 \$
	10A			MAFDR2C06-203010	1	50	184,86 \$
	16A			MAFDR2C06-203016	1	50	184,86 \$
	20A			MAFDR2C06-203020	1	50	184,86 \$
	25A			MAFDR2C06-203025	1	50	184,86 \$
	32A			MAFDR2C06-203032	1	50	184,86 \$
	40A			MAFDR2C06-203040	1	50	184,86 \$
	50A			MAFDR2C06-203050	1	50	184,86 \$
	63A			MAFDR2C06-203063	1	50	184,86 \$
	6A	30 mA	RCBO+AFDD-63	MAFDR2C06-203006	1	50	184,86 \$
	10A			MAFDR2C06-203010	1	50	184,86 \$
	16A			MAFDR2C06-203016	1	50	184,86 \$
	20A			MAFDR2C06-203025	1	50	184,86 \$
	25A			MAFDR2C06-203030	1	50	184,86 \$
	32A			MAFDR2C06-203032	1	50	184,86 \$
	40A			MAFDR2C06-203040	1	50	184,86 \$
	50A			MAFDR2C06-203050	1	50	184,86 \$
	63A			MAFDR2C06-203063	1	50	184,86 \$
2P	6A	30 mA	MCB + AFDD-63	MAFDT2S06-2006	1	50	172,75 \$
	10A			MAFDT2S06-2010	1	50	172,75 \$
	16A			MAFDT2S06-2016	1	50	172,75 \$
	20A			MAFDT2S06-2020	1	50	172,75 \$
	25A			MAFDT2S06-2025	1	50	172,75 \$
	32A			MAFDT2S06-2032	1	50	172,75 \$
	40A			MAFDT2S06-2040	1	50	172,75 \$
	50A			MAFDT2S06-2050	1	50	172,75 \$
	63A			MAFDT2S06-2063	1	50	172,75 \$

MTSIS
**Kutup
Sayısı**
**Amper
(A)**
**İzolatör / Yük Ayırıcı
Seri Kodu**
1 / 2 / 3 / 4
**XXX
32A...125A**

İZOLATÖRLER - YÜK AYIRICILAR

Kutup Sayısı	In (A) Anma Akımı	Ürün Kodu	Kutu Adedi	Koli Adedi	Fiyat (\$)
1P	32A	MTSIS-1032	12	240	7,31 \$
	40A	MTSIS-1040	12	240	7,31 \$
	63A	MTSIS-1063	12	240	7,31 \$
	80A	MTSIS-1080	12	240	9,62 \$
	100A	MTSIS-1100	12	240	9,62 \$
	125A	MTSIS-1125	12	240	9,62 \$
2P	32A	MTSIS-2032	6	120	14,88 \$
	40A	MTSIS-2040	6	120	14,88 \$
	63A	MTSIS-2063	6	120	17,00 \$
	80A	MTSIS-2080	6	120	17,00 \$
	100A	MTSIS-2100	6	120	19,23 \$
	125A	MTSIS-2125	6	120	19,23 \$
3P	32A	MTSIS-3032	4	80	19,23 \$
	40A	MTSIS-3040	4	80	19,23 \$
	63A	MTSIS-3063	4	80	21,53 \$
	80A	MTSIS-3080	4	80	26,27 \$
	100A	MTSIS-3100	4	80	26,27 \$
	125A	MTSIS-3125	4	80	26,27 \$
4P	32A	MTSIS-4032	3	60	26,27 \$
	40A	MTSIS-4040	3	60	26,27 \$
	63A	MTSIS-4063	3	60	28,71 \$
	80A	MTSIS-4080	3	60	28,71 \$
	100A	MTSIS-4100	3	60	35,88 \$
	125A	MTSIS-4125	3	60	37,97 \$

CE
MTSIS SERİSİ

ŞALT GRUBU
CE
MIR00 SERİSİ

DARBE AKIM RÖLELERİ

Kontak	In (A) Anma Akımı	Ürün Kodu	Kutu Adedi	Koli Adedi	Fiyat (\$)
1NO	16A	MIR00-123016	12	120	30,11 \$
2NO	16A	MIR00-223016	12	120	24,86 \$
1NO+1NC	16A	MIR00-223031	12	120	30,77 \$

MATRO SERİSİ

ANALOG ZAMAN SAATİ

Ürün Kodu	Ürün Adı	Kutu Adedi	Koli Adedi	Fiyat (\$)
MATRO-100	100 Saat Analog Zaman Saati	1	100	29,54 \$

CE
CE
MTC00 SERİSİ

TORİD AKIM TRAFOLARI

Ölçüsü	Ürün Kodu	Kutu Adedi	Koli Adedi	Fiyat (\$)
40 mm	MTC00-040	1	100	45,80 \$
80 mm	MTC00-080	1	60	54,09 \$
120 mm	MTC00-120	1	60	76,94 \$
160 mm	MTC00-160	1	30	140,91 \$
210 mm	MTC00-210	1	28	209,10 \$



KAÇAK AKIM ALGILAMA RÖLESİ

Ürün Kodu	Ürün Adı	Kutu Adedi	Koli Adedi	Fiyat (\$)
MELR00-01	Kaçak Akım Algılama Rölesi	1	36	142,05 \$

CE



MTL SERİSİ



KOMPAKT TİP DEVRE KESİCİLER (TERMİK MANYETİK ŞALTER) YANGIN KORUMALI - AÇTIRMA BOBINLİ

Kutup Sayısı	In (A) Anma Akımı	kA	Termik Ayar Sahası (Ir)	Ürün Kodu	mA	Kutu Adedi	Koli Adedi	Fiyat (\$)
4P	16A	25 kA	13-16A	MTL25-4016	30 mA - 300 mA - 500 mA	1	18	296,15 \$
	25A		20-25A	MTL25-4025		1	18	296,15 \$
	32A		25-32A	MTL25-4032		1	18	296,15 \$
	40A		32-40A	MTL25-4040		1	18	300,00 \$
	50A		40-50A	MTL25-4050		1	18	303,85 \$
	63A		50-63A	MTL25-4063		1	18	307,69 \$
	80A		63-80A	MTL25-4080		1	18	315,38 \$
	100A		80-100A	MTL25-4100		1	18	315,38 \$
	125A		100-125A	MTL25-4125		1	18	323,08 \$
	100A	35 kA	80-100A	MTL35-4100		1	12	409,02 \$
	125A		100-125A	MTL35-4125		1	12	409,02 \$
	160A		125-160A	MTL35-4160		1	12	409,02 \$
	200A		160-200A	MTL35-4200		1	12	410,00 \$
	250A		200-250A	MTL35-4250		1	12	440,00 \$
	315A	50 kA	-	MTL50-40315		1	3	793,44 \$
	400A		-	MTL50-40400		1	3	793,44 \$
	500A		-	MTL50-40500		1	2	1.661,93 \$
	630A		-	MTL50-40630		1	2	1.661,93 \$
800A	-		MTL50-40800	*	1	2	1.843,58 \$	

* 800A Kompakt Tip Devre Kesicilerin Yangın Koruma Kademesi 300 - 500 - 1000 mA' dir.

KOMPAKT TİP DEVRE KESİCİLER (TERMİK MANYETİK ŞALTER) YANGIN KORUMALI (NÖTRSÜZ - MOTOR DEVRELERİ İÇİN)



Kutup Sayısı	In (A) Anma Akımı	kA	Termik Ayar Sahası (Ir)	Ürün Kodu	mA	Kutu Adedi	Koli Adedi	Fiyat (\$)
3P	16A	25 kA	13-16A	MTL25-3016	30 mA - 300 mA - 500 mA	1	24	246,13 \$
	25A		20-25A	MTL25-3025		1	24	246,13 \$
	32A		25-32A	MTL25-3032		1	24	256,22 \$
	40A		32-40A	MTL25-3040		1	24	256,22 \$
	50A		40-50A	MTL25-3050		1	24	256,22 \$
	63A		50-63A	MTL25-3063		1	24	264,23 \$
	80A		63-80A	MTL25-3080		1	24	264,23 \$
	100A		80-100A	MTL25-3100		1	24	264,23 \$
	125A		100-125A	MTL25-3125		1	24	264,23 \$
	100A	35 kA	80-100A	MTL35-3100		1	18	368,72 \$
	125A		100-125A	MTL35-3125		1	18	368,72 \$
	160A		125-160A	MTL35-3160		1	18	368,72 \$
	200A		160-200A	MTL35-3200		1	18	368,72 \$
	250A		200-250A	MTL35-3250		1	18	368,72 \$
	315A	50 kA	-	MTL50-30315		1	4	645,14 \$
	400A		-	MTL50-30400		1	4	645,14 \$
	500A		-	MTL50-30500		1	2	1.291,89 \$
	630A		-	MTL50-30630		1	2	1.291,89 \$
800A	-		MTL50-30800	*	1	2	1.433,53 \$	

* 800A Kompakt Tip Devre Kesicilerin Yangın Koruma Kademesi 300 - 500 - 1000 mA' dir.

Seri Kodu

Kiloamper (kA)

Kutup Sayısı

Amper (A)

MTF : Sabit Tip
MTA : Ayar Sahalı
MTL : Kaçak Akımlı

25/35/50

3/4

XXXX
16A...
1600A

KOMPAKT TİP DEVRE KESİCİLER (TERMİK MANYETİK ŞALTER) SABİT TİP

CE

MTF SERİSİ

ŞALT GRUBU

Kutup Sayısı	In (A) Anma Akımı	kA	Ürün Kodu	Kutu Adedi	Koli Adedi	Fiyat (\$)
3P	16A	25 kA	MTF25-3016	1	24	155,42 \$
	25A		MTF25-3025	1	24	155,42 \$
	32A		MTF25-3032	1	24	155,42 \$
	40A		MTF25-3040	1	24	155,42 \$
	50A		MTF25-3050	1	24	155,42 \$
	63A		MTF25-3063	1	24	168,01 \$
	80A		MTF25-3080	1	24	168,01 \$
	100A		MTF25-3100	1	24	168,01 \$
	125A		MTF25-3125	1	24	168,01 \$
	160A		MTF25-3160	1	24	175,34 \$
	100A	35 kA	MTF35-3100	1	18	226,75 \$
	125A		MTF35-3125	1	18	226,75 \$
	160A		MTF35-3160	1	18	226,75 \$
	200A		MTF35-3200	1	18	226,75 \$
	250A		MTF35-3250	1	18	226,75 \$
	315A	50 kA	MTF50-30315	1	4	674,41 \$
	400A		MTF50-30400	1	4	674,41 \$
	500A		MTF50-30500	1	2	1.014,19 \$
630A	MTF50-30630		1	2	1.014,19 \$	
800A	65 kA	MTF50-30800	1	2	1.347,79 \$	
1000A		MTF65-31000	1	1	2.115,39 \$	
1250A		MTF65-31250	1	1	2.178,51 \$	
1600A		MTF65-31600	1	1	2.583,06 \$	
4P	16A	25 kA	MTF25-4016	1	18	191,09 \$
	25A		MTF25-4025	1	18	191,09 \$
	32A		MTF25-4032	1	18	191,09 \$
	40A		MTF25-4040	1	18	191,09 \$
	50A		MTF25-4050	1	18	191,09 \$
	63A		MTF25-4063	1	18	205,75 \$
	80A		MTF25-4080	1	18	205,75 \$
	100A		MTF25-4100	1	18	205,75 \$
	125A		MTF25-4125	1	18	205,75 \$
	160A		MTF25-4160	1	18	213,08 \$
	100A	35 kA	MTF35-4100	1	12	302,24 \$
	125A		MTF35-4125	1	12	302,24 \$
	160A		MTF35-4160	1	12	302,24 \$
	200A		MTF35-4200	1	12	302,24 \$
	250A		MTF35-4250	1	12	302,24 \$
	315A	50 kA	MTF50-40315	1	3	778,32 \$
	400A		MTF50-40400	1	3	778,32 \$
	500A		MTF50-40500	1	2	1.249,95 \$
	630A		MTF50-40630	1	2	1.249,95 \$
	800A	65 kA	MTF50-40800	1	2	1.420,99 \$
	1000A		MTF65-41000	1	1	2.961,54 \$
	1250A		MTF65-41250	1	1	2.975,36 \$
	1600A		MTF65-41600	1	1	3.326,43 \$





KOMPAKT TİP DEVRE KESİCİLER (TERMİK MANYETİK) AYAR SAHALI

MTA SERİSİ



Kutup Sayısı	In (A) Anma Akımı	kA	Termik Ayar Sahası (Ir)	Ürün Kodu	Kutu Adedi	Koli Adedi	Fiyat (\$)
3P	16A	25 kA	13-16A	MTA25-3016	1	24	187,01 \$
	25A		20-25A	MTA25-3025	1	24	187,01 \$
	32A		25-32A	MTA25-3032	1	24	187,01 \$
	40A		32-40A	MTA25-3040	1	24	192,35 \$
	50A		40-50A	MTA25-3050	1	24	192,35 \$
	63A		50-63A	MTA25-3063	1	24	205,84 \$
	80A		63-80A	MTA25-3080	1	24	205,84 \$
	100A		80-100A	MTA25-3100	1	24	212,95 \$
	125A		100-125A	MTA25-3125	1	24	219,29 \$
	160A	125-160A	MTA25-3160	1	24	230,77 \$	
	100A	35 kA	80-100A	MTA35-3100	1	18	250,00 \$
	125A		100-125A	MTA35-3125	1	18	263,94 \$
	160A		125-160A	MTA35-3160	1	18	274,50 \$
	200A		160-200A	MTA35-3200	1	18	307,69 \$
	250A		200-250A	MTA35-3250	1	18	330,77 \$
	315A	50 kA	250-315A	MTA50-30315	1	4	720,69 \$
	400A		320-400A	MTA50-30400	1	4	785,67 \$
	500A		400-500A	MTA50-30500	1	2	1.056,23 \$
630A	500-630A		MTA50-30630	1	2	1.056,23 \$	
800A	630-800A	MTA50-30800	1	2	1.300,70 \$		



4P	16A	25 kA	13-16A	MTA25-4016	1	18	235,28 \$
	25A		20-25A	MTA25-4025	1	18	235,28 \$
	32A		25-32A	MTA25-4032	1	18	235,28 \$
	40A		32-40A	MTA25-4040	1	18	241,57 \$
	50A		40-50A	MTA25-4050	1	18	251,93 \$
	63A		50-63A	MTA25-4063	1	18	251,93 \$
	80A		63-80A	MTA25-4080	1	18	258,53 \$
	100A		80-100A	MTA25-4100	1	18	258,53 \$
	125A		100-125A	MTA25-4125	1	18	263,48 \$
	160A	125-160A	MTA25-4160	1	18	271,67 \$	
	100A	35 kA	80-100A	MTA35-4100	1	12	280,88 \$
	125A		100-125A	MTA35-4125	1	12	280,88 \$
	160A		125-160A	MTA35-4160	1	12	300,37 \$
	200A		160-200A	MTA35-4200	1	12	352,34 \$
	250A		200-250A	MTA35-4250	1	12	378,30 \$
	315A	50 kA	250-315A	MTA50-40315	1	3	748,39 \$
	400A		320-400A	MTA50-40400	1	3	748,39 \$
	500A		400-500A	MTA50-40500	1	2	1.201,87 \$
630A	500-630A		MTA50-40630	1	2	1.201,87 \$	
800A	630-800A	MTA50-40800	1	2	1.923,08 \$		

KOMPAKT TİP DEVRE KESİCİLERİ (TERMİK MANYETİK) AKSESUARLARI

Ürün Kodu	Ürün Adı	Kutu Adedi	Fiyat (\$)
MTAUX-11250	1NO + 1NC - Yardımcı Kontak - 25kA - 35kA Kasa için	1	FİYAT SORUNUZ
MTAUX-22250	2NO + 2NC - Yardımcı Kontak - 25kA - 35kA Kasa için	1	
MTAUX-22400	2NO + 2NC - Yardımcı Kontak - MTF - MTA 50kA Kasa için	1	
MTAUX-22800	2NO + 2NC - Yardımcı Kontak - MTL - 50kA Kasa için	1	
MTAUX-221250	2NO + 2NC - Yardımcı Kontak - MTF - 65kA Kasa için	1	
MTALR-00160	Alarm Kontak - 25kA Kasa için	1	
MTALR-00250	Alarm Kontak - 35kA Kasa için	1	
MTALR-00400	Alarm Kontak - MTF - MTA - 50kA Kasa için	1	
MTALR-00800	Alarm Kontak - MTL - 50kA Kasa için	1	
MTALR-001250	Alarm Kontak - MTF - 65kA Kasa için	1	
MTSHT-230160	Açtırma Bobini - 25kA Kasa için	1	
MTSHT-230250	Açtırma Bobini - 35kA Kasa için	1	
MTSHT-230400	Açtırma Bobini - MTL - 50kA (315A - 400A) Kasa için	1	
MTSHT-230500	Açtırma Bobini - MTL - 50kA (500A - 800A) Kasa için	1	
MTSHT-230630	Açtırma Bobini - MTF - MTA - 50kA (315A - 630A) Kasa için	1	
MTSHT-230800	Açtırma Bobini - MTF - MTA - 50kA (800A) Kasa için	1	
MTSHT-2301250	Açtırma Bobini - MTF - 65kA Kasa için	1	
MTMO-0250	Motor Mekanizması - 35kA Kasa için	1	
MTMO-0400	Motor Mekanizması - MTF - MTA - 50kA (315A - 400A) Kasa için	1	
MTMO-0630	Motor Mekanizması - MTF - MTA - 50kA (500A - 630A) Kasa için	1	
MTMO-0800	Motor Mekanizması - MTF - MTA - 50kA (800A) Kasa için	1	
MTMO-0315	Motor Mekanizması - MTL - 50kA (315A - 400A) Kasa için	1	
MTMO-0500	Motor Mekanizması - MTL - 50kA (500A - 800A) Kasa için	1	
MTMO-1000	Motor Mekanizması - MTF - 65kA Kasa için	1	
MTRH-0250	Döner Uzatma Kolu - 35kA Kasa için	1	
MTRH-0400	Döner Uzatma Kolu - MTF - MTA - 50kA (315A - 400A) Kasa için	1	
MTRH-0630	Döner Uzatma Kolu - MTF - MTA - 50kA (500A - 630A) Kasa için	1	
MTRH-0800	Döner Uzatma Kolu - MTF - MTA - 50kA (800A) Kasa için	1	
MTRH-0315	Döner Uzatma Kolu - MTL - 50kA (315A - 400A) Kasa için	1	
MTRH-0500	Döner Uzatma Kolu - MTL - 50kA (500A - 800A) Kasa için	1	
MTRH-1000	Döner Uzatma Kolu - MTF - 65kA Kasa için	1	
MTIUUV-00400	Düşük Gerilim Bobini - MTF - MTA - 50kA Kasa için	1	
MTIUUV-00800	Düşük Gerilim Bobini - MTL - 50kA Kasa için	1	
MTLAM-00800	Kaçak Akım Alarm Modülü - MTL - 50kA Kasa için	1	
MTSACC-SL3	Emniyet Kilidi Aparatı - 25kA - 35kA Kasa için	1	
MTSACC-SL4	Emniyet Kilidi Aparatı - 50kA (315A - 630A) Kasa için	1	
MTSACC-SL5	Emniyet Kilidi Aparatı - 50kA - 65kA (800A - 1250A) Kasa için	1	

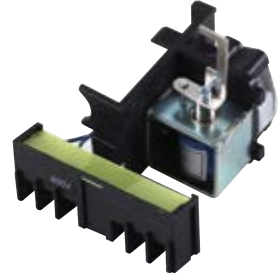
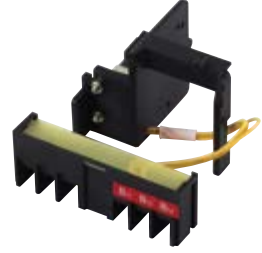
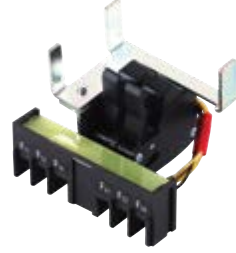
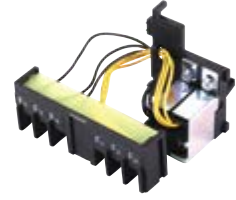

Seri Kodu

Kutup Sayısı

Kiloamper (kA)

Amper (A)

MTACF : Sabit tip
MTACD : Çekmeceli tip

3 / 4

065/120

XXXX
1000A...6300A

CE AÇIK TİP DEVRE KESİCİLER - SABİT TİP

MTACF SERİSİ



Kutup Sayısı	In (A) Anma Akımı	kA	Ürün Kodu	Kutu Adedi	Koli Adedi	Fiyat (\$)
3P	1000A	65 kA	MTACF3-0651000	1	1	3.471,49 \$
	1250A		MTACF3-0651250	1	1	3.471,49 \$
	1600A		MTACF3-0651600	1	1	3.471,49 \$
	2000A		MTACF3-0652000	1	1	4.947,81 \$
	2500A		MTACF3-0652500	1	1	4.947,81 \$
	3200A		MTACF3-0653200	1	1	5.513,99 \$
	4000A	120 kA	MTACF3-1204000	1	1	12.537,95 \$
	5000A		MTACF3-1205000	1	1	14.452,33 \$
	6300A	MTACF3-1206300	1	1	16.245,43 \$	
4P	1000A	65 kA	MTACF4-0651000	1	1	4.307,40 \$
	1250A		MTACF4-0651250	1	1	4.307,40 \$
	1600A		MTACF4-0651600	1	1	4.307,40 \$
	2000A		MTACF4-0652000	1	1	6.403,79 \$
	2500A		MTACF4-0652500	1	1	6.403,79 \$
	3200A		MTACF4-0653200	1	1	7.414,88 \$
	4000A	120 kA	MTACF4-1204000	1	1	14.775,87 \$
	5000A		MTACF4-1205000	1	1	15.908,32 \$
	6300A	MTACF4-1206300	1	1	17.458,77 \$	

CE AÇIK TİP DEVRE KESİCİLER - ÇEKMECELİ TİP

MTACD SERİSİ



Kutup Sayısı	In (A) Anma Akımı	kA	Ürün Kodu	Kutu Adedi	Koli Adedi	Fiyat (\$)
3P	1000A	65 kA	MTACD3-0651000	1	1	5.075,84 \$
	1250A		MTACD3-0651250	1	1	5.075,84 \$
	1600A		MTACD3-0651600	1	1	5.075,84 \$
	2000A		MTACD3-0652000	1	1	5.911,75 \$
	2500A		MTACD3-0652500	1	1	7.994,65 \$
	3200A		MTACD3-0653200	1	1	9.275,37 \$
	4000A	120 kA	MTACD3-1204000	1	1	15.126,39 \$
	5000A		MTACD3-1205000	1	1	23.471,56 \$
	6300A	MTACD3-1206300	1	1	27.502,57 \$	
4P	1000A	65 kA	MTACD4-0651000	1	1	6.194,79 \$
	1250A		MTACD4-0651250	1	1	6.194,79 \$
	1600A		MTACD4-0651600	1	1	6.194,79 \$
	2000A		MTACD4-0652000	1	1	10.353,92 \$
	2500A		MTACD4-0652500	1	1	10.353,92 \$
	3200A		MTACD4-0653200	1	1	12.133,53 \$
	4000A	120 kA	MTACD4-1204000	1	1	18.847,36 \$
	5000A		MTACD4-1205000	1	1	26.612,77 \$
	6300A	MTACD4-1206300	1	1	28.581,13 \$	

AÇIK TİP DEVRE KESİCİLERİ AKSESUARLARI

Ürün Kodu	Ürün Adı	Kutu Adedi	Fiyat (\$)
MTACSHT-1000	Açtırma Bobini (1000-1600A)	1	
MTACSHT-2000	Açtırma Bobini (2000A)	1	
MTACSHT-4000	Açtırma Bobini (2500-4000A)	1	
MTACSHT-6300	Açtırma Bobini (5000-6300A)	1	
MTACIUUV-1000	Düşük Gerilim Bobini (1000-1600A)	1	
MTACIUUV-2000	Düşük Gerilim Bobini (2000A)	1	
MTACIUUV-4000	Düşük Gerilim Bobini (2500-4000A)	1	
MTACIUUV-6300	Düşük Gerilim Bobini (5000-6300A)	1	
MTACSUV-1000	Gecikmesiz Düşük Gerilim Bobini (1000-1600A)	1	
MTACSUV-2000	Gecikmesiz Düşük Gerilim Bobini (2000A)	1	
MTACSUV-4000	Gecikmesiz Düşük Gerilim Bobini (2500-4000A)	1	
MTACSUV-6300	Gecikmesiz Düşük Gerilim Bobini (5000-6300A)	1	
MTACUV-1000	Gecikmeli Düşük Gerilim Bobini (1000-1600A)	1	
MTACUV-2000	Gecikmeli Düşük Gerilim Bobini (2000A)	1	
MTACUV-4000	Gecikmeli Düşük Gerilim Bobini (2500-4000A)	1	
MTACUV-6300	Gecikmeli Düşük Gerilim Bobini (5000-6300A)	1	
MTACM-1000	Motor Mekanizması (1000-1600A)	1	
MTACM-2000	Motor Mekanizması (2000A)	1	
MTACM-4000	Motor Mekanizması (2500-4000A)	1	
MTACM-6300	Motor Mekanizması (5000-6300A)	1	
MTACCC-1000	Kapatma Bobini (1000-1600A)	1	
MTACCC-2000	Kapatma Bobini (2000A)	1	
MTACCC-4000	Kapatma Bobini (2500-4000A)	1	
MTACCC-6300	Kapatma Bobini (5000-6300A)	1	
MTACMIM2-1000	Mekanik Kilitleme Ünitesi 2 Devre Kesici için (1000-1600A)	1	
MTACMIM2-2000	Mekanik Kilitleme Ünitesi 2 Devre Kesici için (2000A)	1	
MTACMIM2-4000	Mekanik Kilitleme Ünitesi 2 Devre Kesici için (2500-4000A)	1	
MTACMIM2-6300	Mekanik Kilitleme Ünitesi 2 Devre Kesici için (5000-6300A)	1	
MTACMIM3-1000	Mekanik Kilitleme Ünitesi 3 Devre Kesici için (2 ON+1 OFF) (1000-1600A)	1	
MTACMIM3-2000	Mekanik Kilitleme Ünitesi 3 Devre Kesici için (2 ON+1 OFF)(2000A)	1	
MTACMIM3-4000	Mekanik Kilitleme Ünitesi 3 Devre Kesici için (2 ON+1 OFF)(2500-4000A)	1	
MTACMIM3-6300	Mekanik Kilitleme Ünitesi 3 Devre Kesici için (2 ON+1 OFF) (5000-6300A)	1	
MTAC1MC-1000	LSI Dijital Ekranlı Kontrol Ünitesi (1000-1600A)	1	
MTAC1MC-2000	LSI Dijital Ekranlı Kontrol Ünitesi (2000A)	1	
MTAC1MC-4000	LSI Dijital Ekranlı Kontrol Ünitesi (2500-4000A)	1	
MTAC1MC-6300	LSI Dijital Ekranlı Kontrol Ünitesi (5000-6300A)	1	
MTAC3MC-1000	LSIG LCD Ekranlı Kontrol Ünitesi (1000-1600A)	1	
MTAC3MC-2000	LSIG LCD Ekranlı Kontrol Ünitesi (2000A)	1	
MTAC3MC-4000	LSIG LCD Ekranlı Kontrol Ünitesi (2500-4000A)	1	
MTAC3MC-6300	LSIG LCD Ekranlı Kontrol Ünitesi (5000-6300A)	1	
MTAC3HC-1000	LSIG Çok Fonksiyonlu LCD Ekranlı Kontrol Ünitesi (1000-1600A)	1	
MTAC3HC-2000	LSIG Çok Fonksiyonlu LCD Ekranlı Kontrol Ünitesi (2000A)	1	
MTAC3HC-4000	LSIG Çok Fonksiyonlu LCD Ekranlı Kontrol Ünitesi (2500-4000A)	1	
MTAC3HC-6300	LSIG Çok Fonksiyonlu LCD Ekranlı Kontrol Ünitesi (5000-6300A)	1	
MTACN-1000	Nötr Akım Trafosu (1000-1600A)	1	
MTACN-2000	Nötr Akım Trafosu (2000A)	1	
MTACN-4000	Nötr Akım Trafosu (2500-4000A)	1	
MTACN-6300	Nötr Akım Trafosu (5000-6300A)	1	
MTACZP-1000	Toprak Akım Trafosu (1000-1600A)	1	
MTACZP-2000	Toprak Akım Trafosu (2000A)	1	
MTACZP-4000	Toprak Akım Trafosu (2500-4000A)	1	
MTACZP-6300	Toprak Akım Trafosu (5000-6300A)	1	
MTACPS-1000	Faz Seperatörü (1000-1600A)	1	
MTACPS-2000	Faz Seperatörü (2000A)	1	
MTACPS-4000	Faz Seperatörü (2500-4000A)	1	
MTACPS-6300	Faz Seperatörü (5000-6300A)	1	
MTACDF-1000	Kapı Çerçevesi (1000-1600A)	1	
MTACDF-2000	Kapı Çerçevesi (2000A)	1	
MTACDF-4000	Kapı Çerçevesi (2500-4000A)	1	
MTACDF-6300	Kapı Çerçevesi (5000-6300A)	1	

FİYAT SORUNUZ



Kapatma Bobinleri

Açtırma Bobinleri



Düşük Gerilim Bobini



Motor Mekanizması



İkili Mekanik Kilitleme

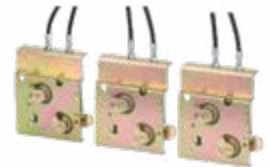

Üçlü Mekanik Kilitleme



Ekranlı Kontrol Ünitesi



Nötr Akım Trafosu



Toprak Akım Trafosu

CE OTOMATİK TRANSFER ŞALTERLERİ (ATS) KÜÇÜK KASA

MATS SERİSİ



Kutup Sayısı	In (A) Anma Akımı	Ürün Kodu	Kutu Adedi	Fiyat (\$)
2P	10A	MATS-2010	1	FİYAT SORUNUZ
	16A	MATS-2016	1	
	20A	MATS-2020	1	
	25A	MATS-2025	1	
	32A	MATS-2032	1	
	40A	MATS-2040	1	
	50A	MATS-2050	1	
63A	MATS-2063	1		
4P	10A	MATS-4010	1	
	16A	MATS-4016	1	
	20A	MATS-4020	1	
	25A	MATS-4025	1	
	32A	MATS-4032	1	
	40A	MATS-4040	1	
	50A	MATS-4050	1	
63A	MATS-4063	1		

MTATS
 Oto. Transfer Şalteri
 Seri Kodu - Kutup Sayısı - Amper (A)
 4 - XXX
 100A...3200A

CE OTOMATİK TRANSFER ŞALTERLERİ (ATS)

MTATS SERİSİ



Kutup Sayısı	In (A) Anma Akımı	Ürün Kodu	Kutu Adedi	Fiyat (\$)
4P	100A	MTATS-40100	1	450,00 \$
	160A	MTATS-40160	1	692,31 \$
	250A	MTATS-40250	1	769,23 \$
	400A	MTATS-40400	1	1.200,00 \$
	630A	MTATS-40630	1	1.615,38 \$
	1000A	MTATS-41000	1	3.269,23 \$
	1250A	MTATS-41250	1	3.769,23 \$
	1600A	MTATS-41600	1	4.230,77 \$
	2000A	MTATS-42000	1	9.230,77 \$
	2500A	MTATS-42500	1	11.000,00 \$
	3200A	MTATS-43200	1	13.000,00 \$

MTMA	Kontakt	Kutup Sayısı	Amper (A)
AC Kontaktör Seri Kodu	10 : 1NO 01 : 1NC 11 : 1NO+1NC	3/4	XXX 9A...95A

AC KONTAKTÖRLER - 230V AC

Kutup Sayısı	In (A) Anma Akımı	kW	Kontakt	Voltaj (V)	Ürün Kodu	Kutu Adedi	Koli Adedi	Fiyat (\$)
3P	9A	4kW	1NO	230V AC	MTMA10-3009	1	50	17,60 \$
	9A	4kW	1NC		MTMA01-3009	1	50	17,60 \$
	9A	4kW	1NO+1NC		MTMA11-3009	1	50	19,23 \$
	12A	5,5kW	1NO		MTMA10-3012	1	50	19,23 \$
	12A	5,5kW	1NC		MTMA01-3012	1	50	19,23 \$
	12A	5,5kW	1NO+1NC		MTMA11-3012	1	50	23,08 \$
	18A	7,5kW	1NO		MTMA10-3018	1	50	23,08 \$
	18A	7,5kW	1NC		MTMA01-3018	1	50	23,08 \$
	18A	7,5kW	1NO+1NC		MTMA11-3018	1	50	25,00 \$
	25A	11kW	1NO		MTMA10-3025	1	50	30,92 \$
	25A	11kW	1NC		MTMA01-3025	1	50	30,92 \$
	25A	11kW	1NO+1NC		MTMA11-3025	1	50	32,69 \$
	32A	15kW	1NO		MTMA10-3032	1	50	38,46 \$
	32A	15kW	1NC		MTMA01-3032	1	50	38,46 \$
	32A	15kW	1NO+1NC		MTMA11-3032	1	50	42,31 \$
	40A	18,5kW	1NO+1NC		MTMA11-3040	1	20	73,08 \$
	50A	22kW	1NO+1NC		MTMA11-3050	1	20	75,14 \$
	65A	30kW	1NO+1NC		MTMA11-3065	1	20	88,52 \$
80A	37kW	1NO+1NC	MTMA11-3080	1	12	113,46 \$		
95A	45kW	1NO+1NC	MTMA11-3095	1	12	117,31 \$		
4P	9A	4kW	-	MTMA00-4009	1	50	26,50 \$	
	12A	5,5kW	-	MTMA00-4012	1	50	26,50 \$	
	18A	7,5kW	-	MTMA00-4018	1	50	26,50 \$	
	25A	11kW	-	MTMA00-4025	1	50	40,15 \$	
	32A	15kW	-	MTMA00-4032	1	50	40,15 \$	
	40A	18,5kW	-	MTMA00-4040	1	20	105,79 \$	
	50A	22kW	-	MTMA00-4050	1	20	120,38 \$	
	65A	30kW	-	MTMA00-4065	1	20	141,21 \$	
	80A	37kW	-	MTMA00-4080	1	20	188,67 \$	
	95A	45kW	-	MTMA00-4095	1	20	197,93 \$	



MTMA SERİSİ



AC/DC KONTAKTÖRLER GÜÇ DEVRESİ AC, KUMANDA DEVRESİ AC/ DC

Kutup Sayısı	In (A) Anma Akımı	kW	Kontakt	Voltaj (V)	Ürün Kodu	Kutu Adedi	Koli Adedi	Fiyat (\$)
3P	9A	4kW	1NO+1NC	24-48V 100-240V AC/DC	MTMAD11-3009	1	50	FİYAT SORUNUZ
	12A	5,5kW	1NO+1NC		MTMAD11-3012	1	50	
	18A	7,5kW	1NO+1NC		MTMAD11-3018	1	50	
	25A	11kW	1NO+1NC		MTMAD11-3025	1	50	
	32A	15kW	1NO+1NC		MTMAD11-3032	1	50	
	40A	18,5kW	1NO+1NC		MTMAD11-3040	1	20	
	50A	22kW	1NO+1NC		MTMAD11-3050	1	20	
	65A	30kW	1NO+1NC		MTMAD11-3065	1	20	
	80A	37kW	1NO+1NC		MTMAD11-3080	1	12	
	95A	45kW	1NO+1NC		MTMAD11-3095	1	12	
	120A	55kW	2NO+2NC		MTMAD22-3120	1	1	
	160A	75kW	2NO+2NC		MTMAD22-3160	1	1	
	185A	90kW	2NO+2NC		MTMAD22-3185	1	1	
	225A	110kW	2NO+2NC		MTMAD22-3225	1	1	
265A	132kW	2NO+2NC	MTMAD22-3265	1	1			



MTMAD SERİSİ



9A - 95A



120A - 265A



Yardımcı Kontaktörler



Zaman Rölesi

Mekanik Kilitleme

KONTAKTÖR YARDIMCI AKSESUARLARI

Ürün Kodu	Ürün Adı	Kutu Adedi	Koli Adedi	Fiyat (\$)
MTMAUX-UPBLOCKA	Kontaktör Üst Blok A (1NO + 1NC)	1	300	5,24 \$
MTMAUX-UPBLOCKB	Kontaktör Üst Blok B (2NO + 2NC)	1	208	8,61 \$
MTMAUX-SIDEBLOCK	Kontaktör Yan Blok (9A-32A) Kasa için (1NO + 1NC)	1	128	11,31 \$
MTMAUX-T030	0-30 Saniye Zaman Rölesi	1	50	15,88 \$
MTMAUX-MI32	9-32A Mekanik Kilitleme	1	50	11,80 \$
MTMAUX-MI95	40-95A Mekanik Kilitleme	1	50	14,00 \$

MTMK	Kontakt	Kutup Sayısı	Amper (A)	Akım Tipi
Mini Kontaktör Seri Kodu	10 : 1NO 01 : 1NC	3	XXX 9A...16A	230V AC 24V DC / DC24



MINİ KONTAKTÖRLER

MTMK SERİSİ



Kutup Sayısı	In (A) Anma Akımı	kW	Kontakt	Voltaj (V)	Ürün Kodu	Kutu Adedi	Koli Adedi	Fiyat (\$)
3P	6A	2,2kW	1NO	230V AC	MTMK10-3006	1	100	21,15 \$
	9A	4kW	1NO		MTMK10-3009	1	100	21,15 \$
	12A	5,5kW	1NO		MTMK10-3012	1	100	23,85 \$
	16A	7,5kW	1NO		MTMK10-3016	1	100	28,38 \$
	6A	2,2kW	1NC	230V AC	MTMK01-3006	1	100	21,15 \$
	9A	4kW	1NC		MTMK01-3009	1	100	21,15 \$
	12A	5,5kW	1NC		MTMK01-3012	1	100	23,85 \$
	16A	7,5kW	1NC		MTMK01-3016	1	100	28,38 \$
	6A	2,2kW	1NO	24V DC	MTMK10-3006DC24	1	100	36,54 \$
	9A	4kW	1NO		MTMK10-3009DC24	1	100	48,48 \$
	12A	5,5kW	1NO		MTMK10-3012DC24	1	100	51,25 \$
	16A	7,5kW	1NO		MTMK10-3016DC24	1	100	54,01 \$
6A	2,2kW	1NC	24V DC	MTMK01-3006DC24	1	100	36,54 \$	
9A	4kW	1NC		MTMK01-3009DC24	1	100	48,48 \$	
12A	5,5kW	1NC		MTMK01-3012DC24	1	100	51,25 \$	
16A	7,5kW	1NC		MTMK01-3016DC24	1	100	54,01 \$	

MINİ KONTAKTÖR YARDIMCI AKSESUARLARI

Ürün Kodu	Ürün Adı	Kutu Adedi	Koli Adedi	Fiyat (\$)
MTMKUX-UPBLOCKA	Mini Kontaktör Üst Blok A (1NO + 1NC)	1	300	6,68 \$
MTMKUX-UPBLOCKB	Mini Kontaktör Üst Blok B (2NO + 2NC)	1	208	10,15 \$



AC KOMPANZASYON KONTAKTÖRLERİ

MTMAC SERİSİ



Kutup Sayısı	kVAr	Ürün Kodu	Kutu Adedi	Koli Adedi	Fiyat (\$)
3P	7,5kVAr	MTMAC1-318	1	18	51,05 \$
	12kVAr	MTMAC1-325	1	18	65,37 \$
	18kVAr	MTMAC1-332	1	18	83,39 \$
	20kVAr	MTMAC1-343	1	20	84,09 \$
	25kVAr	MTMAC1-350	1	20	115,38 \$
	30kVAr	MTMAC1-365	1	20	143,23 \$
	40kVAr	MTMAC1-380	1	20	191,75 \$
	50kVAr	MTMAC1-395	1	20	228,71 \$
	60kVAr	MTMAC1-399	1	20	346,15 \$

MTMCO	Kutup Sayısı	Amper (A)	Kontakt
Modüler Kontaktör Seri Kodu	2/4	XXX 16A...100A	11 : 1NO+1NC 31 : 3NO+1NC 20 : 2NO 13 : 1NO+3NC 02 : 2NC 40 : 4NO 22 : 2NO+2NC 04 : 4NC

MODÜLER KONTAKTÖRLER



MTMCO SERİSİ

Kutup Sayısı	In (A) Anma Akımı	Kontakt	mm	Ürün Kodu	Kutu Adedi	Koli Adedi	Fiyat (\$)
2P	16A	1NO+1NC	18 mm	MTMCO-201611	1	140	22,09 \$
	16A	2NO		MTMCO-201620	1	140	22,09 \$
	16A	2NC		MTMCO-201602	1	140	22,09 \$
	25A	1NO+1NC		MTMCO-202511	1	140	24,89 \$
	25A	2NO		MTMCO-202520	1	140	24,89 \$
	25A	2NC		MTMCO-202502	140	24,89 \$	
	32A	1NO+1NC	36 mm	MTMCO-203211	1	70	45,19 \$
	32A	2NO		MTMCO-203220	1	70	45,19 \$
	32A	2NC		MTMCO-203202	1	70	45,19 \$
	40A	1NO+1NC		MTMCO-204011	1	70	63,20 \$
	40A	2NO		MTMCO-204020	1	70	63,20 \$
	40A	2NC		MTMCO-204002	1	70	63,20 \$
	63A	1NO+1NC	54 mm	MTMCO-206311	1	70	79,05 \$
	63A	2NO		MTMCO-206320	1	70	79,05 \$
	63A	2NC		MTMCO-206302	1	70	79,05 \$
	80A	1NO+1NC		MTMCO-208011	1	50	96,24 \$
	80A	2NO		MTMCO-208020	1	50	96,24 \$
	80A	2NC		MTMCO-208002	1	50	96,24 \$
100A	1NO+1NC	54 mm	MTMCO-2010011	1	50	96,24 \$	
100A	2NO		MTMCO-2010020	1	50	96,24 \$	
100A	2NC		MTMCO-2010002	1	50	96,24 \$	
4P	16A	2NO+2NC	36 mm	MTMCO-401622	1	70	40,52 \$
	16A	3NO+1NC		MTMCO-401631	1	70	40,52 \$
	16A	1NO+3NC		MTMCO-401613	1	70	40,52 \$
	16A	4NO		MTMCO-401640	1	70	40,52 \$
	16A	4NC		MTMCO-401604	1	70	40,52 \$
	25A	2NO+2NC		MTMCO-402522	1	70	42,31 \$
	25A	3NO+1NC		MTMCO-402531	1	70	42,31 \$
	25A	1NO+3NC		MTMCO-402513	1	70	42,31 \$
	25A	4NO		MTMCO-402540	1	70	42,31 \$
	25A	4NC		MTMCO-402504	1	70	42,31 \$
	32A	2NO+2NC	54 mm	MTMCO-403222	1	50	56,56 \$
	32A	3NO+1NC		MTMCO-403231	1	50	56,56 \$
	32A	1NO+3NC		MTMCO-403213	1	50	56,56 \$
	32A	4NO		MTMCO-403240	1	50	56,56 \$
	32A	4NC		MTMCO-403204	1	50	56,56 \$
	40A	2NO+2NC		MTMCO-404022	1	50	68,40 \$
	40A	3NO+1NC		MTMCO-404031	1	50	68,40 \$
	40A	1NO+3NC		MTMCO-404013	1	50	68,40 \$
	40A	4NO		MTMCO-404040	1	50	68,40 \$
	40A	4NC		MTMCO-404004	1	50	68,40 \$
	63A	2NO+2NC	54 mm	MTMCO-406322	1	50	83,22 \$
	63A	3NO+1NC		MTMCO-406331	1	50	83,22 \$
	63A	1NO+3NC		MTMCO-406313	1	50	83,22 \$
	63A	4NO		MTMCO-406340	1	50	83,22 \$
	63A	4NC		MTMCO-406304	1	50	83,22 \$
	80A	2NO+2NC		108 mm	MTMCO-408022	1	30
	80A	3NO+1NC	MTMCO-408031		1	30	190,77 \$
	80A	1NO+3NC	MTMCO-408013		1	30	190,77 \$
	80A	4NO	MTMCO-408040		1	30	190,77 \$
	80A	4NC	MTMCO-408004		1	30	190,77 \$
100A	2NO+2NC	108 mm	MTMCO-410022		1	30	198,08 \$
100A	3NO+1NC		MTMCO-410031		1	30	198,08 \$
100A	1NO+3NC		MTMCO-410013		1	30	198,08 \$
100A	4NO		MTMCO-410040		1	30	198,08 \$
100A	4NC		MTMCO-410004		1	30	198,08 \$



CE TERMİK RÖLELER

MTTR SERİSİ



Termik Ayar Sahası (A)	Ürün Kodu	Kutu Adedi	Koli Adedi	Fiyat (\$)
0,1 ~ 0,16A	MTTR1-M1301	1	50	21,65 \$
0,16 ~ 0,25A	MTTR1-M1302	1	50	21,65 \$
0,25 ~ 0,40A	MTTR1-M1303	1	50	21,65 \$
0,40 ~ 0,63A	MTTR1-M1304	1	50	21,65 \$
0,63 ~ 1A	MTTR1-M1305	1	50	21,65 \$
1 ~ 1,6A	MTTR1-M1306	1	50	21,65 \$
1,6 ~ 2,5A	MTTR1-M1307	1	50	21,65 \$
2,5 ~ 4A	MTTR1-M1308	1	50	21,65 \$
4 ~ 6A	MTTR1-M1310	1	50	21,65 \$
5,5 ~ 8A	MTTR1-M1312	1	50	21,65 \$
7 ~ 10A	MTTR1-M1314	1	50	21,65 \$
9 ~ 13A	MTTR1-M1316	1	50	21,65 \$
12 ~ 18A	MTTR1-M1321	1	50	21,65 \$
17 ~ 25A	MTTR1-M1322	1	50	21,65 \$
23 ~ 32A	MTTR2-M2353	1	75	32,39 \$
30 ~ 40A	MTTR2-M2355	1	75	32,39 \$
17 ~ 25A BÜYÜK	MTTR3-M3322	1	50	53,31 \$
23 ~ 32A BÜYÜK	MTTR3-M3353	1	50	53,30 \$
30 ~ 40A BÜYÜK	MTTR3-M3355	1	50	53,85 \$
37 ~ 50A	MTTR3-M3357	1	50	55,77 \$
48 ~ 65A	MTTR3-M3359	1	50	57,69 \$
55 ~ 70A	MTTR3-M3361	1	50	64,62 \$
63 ~ 80A	MTTR3-M3363	1	50	66,15 \$
80 ~ 93A	MTTR3-M3365	1	50	71,15 \$

TERMİK RÖLELER - BARALI

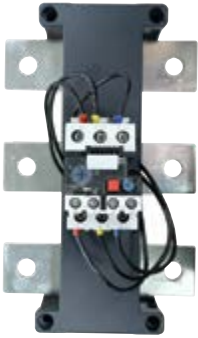

Termik Ayar Sahası (A)	Ürün Kodu	Kutu Adedi	Fiyat (\$)
51 ~ 81A	MTTR4-M4381	1	FİYAT SORUNUZ
62 ~ 99A	MTTR4-M4399	1	
84 ~ 135A	MTTR4-M43135	1	
124 ~ 198A	MTTR5-M53198	1	
146 ~ 234A	MTTR6-M63234	1	
174 ~ 279A	MTTR6-M63279	1	

TERMİK RÖLE RAY MONTAJ APARATLARI



Ürün Kodu	Ürün Adı	Kutu Adedi	Koli Adedi	Fiyat (\$)
MTTRMB-1	Ray Montaj Aparatı MTTR1 Kasa için	1	100	5,80 \$
MTTRMB-2	Ray Montaj Aparatı MTTR2 Kasa için	1	100	7,22 \$
MTTRMB-3	Ray Montaj Aparatı MTTR3 Kasa için	1	30	17,70 \$

MOTOR KORUMA ŞALTERLERİ

CE

MTPSO SERİSİ

KW	Termik Ayar Sahası (A)	Ürün Kodu	Kutu Adedi	Koli Adedi	Fiyat (\$)
-	0,1 - 0,16A	MTPSO-250016	1	50	42,60 \$
0.06	0,16 - 0,25A	MTPSO-250025	1	50	42,60 \$
0.09	0,25 - 0,40A	MTPSO-250040	1	50	42,60 \$
0.12-0.19	0,40 - 0,63A	MTPSO-250063	1	50	45,03 \$
0.25	0,63-1A	MTPSO-250100	1	50	45,03 \$
0.37-0.55	1 - 1,6A	MTPSO-250160	1	50	45,03 \$
0.75	1,6 - 2,5A	MTPSO-250250	1	50	45,03 \$
1.5	2,5 - 4A	MTPSO-250400	1	50	45,03 \$
2.2	4 - 6,3A	MTPSO-250630	1	50	46,88 \$
4	6 - 10A	MTPSO-251000	1	50	46,88 \$
5.5	9 - 14A	MTPSO-251400	1	50	47,46 \$
7.5	13 - 18A	MTPSO-251800	1	50	48,61 \$
9	17 - 23A	MTPSO-252300	1	50	49,89 \$
11	20 - 25A	MTPSO-252500	1	50	49,89 \$
15	24 - 32A	MTPSO-253200	1	50	73,85 \$
18.5	25 - 40A	MTPS1-804000	1	50	140,05 \$
22	36 - 50A	MTPS1-805000	1	50	173,08 \$
30	40 - 63A	MTPS1-806300	1	50	173,08 \$
37	56 - 80A	MTPS1-808000	1	50	207,18 \$



MOTOR KORUMA ŞALTERİ AKSESUARLARI

Ürün Kodu	Ürün Adı	Kutu Ad.	Koli Ad.	Fiyat (\$)
MTPSO-F11	1NO+1NC Yardımcı Kontak - Üstten Montajlı (MTPSO Kasa için)	1	1000	9,25 \$
MTPSO-F20	2NO Yardımcı Kontak - Üstten Montajlı (MTPSO Kasa için)	1	1000	9,27 \$
MTPSO-L11	1NO+1NC Yardımcı Kontak - Yandan Montajlı (MTPSO Kasa için)	1	500	14,47 \$
MTPSO-L20	2NO Yardımcı Kontak - Yandan Montajlı (MTPSO Kasa için)	1	500	14,46 \$
MTPS1-L11	1NO+1NC Yardımcı Kontak - Yandan Montajlı (MTPS1 Kasa için)	1	500	19,23 \$
MTPS1-L20	2NO Yardımcı Kontak - Yandan Montajlı (MTPS1 Kasa için)	1	500	19,23 \$
MTPSO-AB	Açtırma Bobini (MTPSO Kasa için)	1	500	17,31 \$
MTPSO-DG	400V Düşük Gerilim Açtırma Bobini (MTPSO Kasa için)	1	300	26,92 \$
MTPSO-IP55K	IP55 Kutu (MTPSO Kasa için)	1	50	19,23 \$



MOTOR DEVRELERİNDE SEÇİM TABLOSU

DİREKT YOL VERME, 0.06-37 kW AC3 SINIFINDA, 3 FAZLI 50/60 Hz

Motorların Standart Güç Değerleri		Motor Koruma Şalteri Referans Kodu	Termik Röle Referans Kodu	Kontaktör Referans Kodu
kW	A		Ayar Sahası (A)	
0.06	0.22	MTP50-250025	0.16 ~ 0.25	MTMAXX-3009
0.09	0.36	MTP50-250040	0.25 ~ 0.40	MTMAXX-3009
0.12	0.42	MTP50-250063	0.40 ~ 0.63	MTMAXX-3009
0.18	0.6	MTP50-250063	0.40 ~ 0.63	MTMAXX-3009
0.25	0.88	MTP50-250100	0.63 ~ 1	MTMAXX-3009
0.37	0.98	MTP50-250100	0.63 ~ 1	MTMAXX-3009
0.55	1.5	MTP50-250160	0.16 ~ 0.25	MTMAXX-3009
0.75	2	MTP50-250250	1 ~ 1.6	MTMAXX-3009
1.1	2.5	MTP50-250400	2.5 ~ 4	MTMAXX-3009
1.5	3.5	MTP50-250400	2.5 ~ 4	MTMAXX-3009
2.2	5	MTP50-250630	4 ~ 6	MTMAXX-3009
3	6.5	MTP50-251000	7 ~ 10	MTMAXX-3009
4	8.4	MTP50-251000	7 ~ 10	MTMAXX-3009
5.5	11	MTP50-251400	9 ~ 13	MTMAXX-3012
7.5	14.8	MTP50-251800	12 ~ 18	MTMAXX-3018
9	18.1	MTP50-252300	17 ~ 25	MTMAXX-3025
11	21	MTP50-252500	17 ~ 25	MTMAXX-3025
15	28.5	MTP50-253200	23 ~ 32	MTMA11-3032
18.5	35	MTP50-804000	30 ~ 40	MTMA11-3040
22	41	MTP50-805000	37 ~ 50	MTMA11-3050
30	55	MTP50-806300	48 ~ 65	MTMA11-3065
37	69	MTP50-808000	55 ~ 70	MTMA11-3080

XX = 01 (1NC)
 XX = 10 (1NO)
 XX = 11 (1NO+1NC)

* Yukarıdaki değerler rehber niteliğinde verilmiştir. Motor tipine ve üreticisine göre değişiklik gösterebilir.

ANAHTAR PRİZ GRUBU



MODÜLER SİSTEM



Stella'nın
Kavisli Zarafeti

Stella

FARK YARATAN DOKUNUŞLAR

Mutlusan Modüler Seri, küçük bir alanda mümkün olduğu kadar çok ekipmanın kurulum imkanı da dahil olmak üzere, ekipman ve renk kombinasyonu seçiminde tam özerkliğe sahip olmak isteyen müşterilerin ihtiyaçlarına uygun olarak geliştirildi.

Bu seri aynı zamanda anahtar ve prizlerin uzun ömürlü olmasını ve rahat uygulanmasını garanti eden ekipman kalitesi açısından da beklentileri karşılıyor.

- Avrupa standartlarına uygun üretim
- Yüksek kaliteli hammadde kullanımı
- Koruma seviyesi: IP 20
- Kolay montaj
- Kişileştirilebilir modül ve çerçeveler
- Geniş dekoratif çerçeve yelpazesi
- Yeni ürünlerle sürekli gelişen ürün yelpazesi

Alessa'nın
Keskin Hat ve Güçlü Stili



Alessa



Stella | Alessa

Renkler



01 - BEYAZ

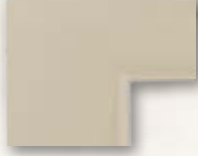

02 - KREM



62 - METALİK SİYAH



80 - ANTİK ALTIN



84 - SİYAH



86 - ANTRASİT



88 - SU YEŞİLİ



92 - ANTİK GÜMÜŞ



95 - FÜME



97 - SATEN BEJ

XX = Renk Kodlarının Karşılığıdır.

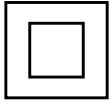

2M

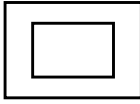

3M

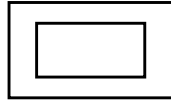

4M

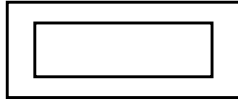

7M

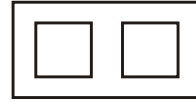

2x2M

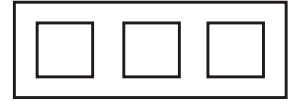

3x2M



Stella

Kod	Ürün Tanımı	Kutu Adedi	Koli Adedi	Beyaz/Krem Fiyat (₺)	Renkli Fiyat (₺)
Çerçeveler					
2440 800 12XX	Stella 2M Çerçeve	20	-	124,43	181,82
2440 800 13XX	Stella 3M Çerçeve	20	-	184,34	227,27
2440 800 14XX	Stella 4M Çerçeve	10	-	221,23	272,73
2440 800 17XX	Stella 7M Çerçeve	10	-	271,04	409,09
2430 800 12XX	Stella Plus 2x2M Çerçeve	10	-	292,79	500,00
2430 800 13XX	Stella Plus 3x2M Çerçeve	10	-	383,37	727,27

Alessa

Kod	Ürün Tanımı	Kutu Adedi	Koli Adedi	Beyaz/Krem Fiyat (₺)	Renkli Fiyat (₺)
Beyaz Fonlu Çerçeveler					
2420 801 12XX	Alessa 2M Çerçeve - Beyaz Fonlu	20	-	209,09	318,18
2420 801 13XX	Alessa 3M Çerçeve - Beyaz Fonlu	20	-	240,91	363,64
2420 801 14XX	Alessa 4M Çerçeve - Beyaz Fonlu	10	-	300,00	409,09
2420 801 17XX	Alessa 7M Çerçeve - Beyaz Fonlu	10	-	363,64	500,00
2450 801 12XX	Alessa Plus 2x2M Çerçeve - Beyaz Fonlu	10	-	386,69	636,36
2450 801 13XX	Alessa Plus 3x2M Çerçeve - Beyaz Fonlu	10	-	533,00	818,18

Alessa

Kod	Ürün Tanımı	Kutu Adedi	Koli Adedi	Beyaz/Krem Fiyat (₺)	Renkli Fiyat (₺)
Siyah Fonlu Çerçeveler					
2420 811 12XX	Alessa 2M Çerçeve - Siyah Fonlu	20	-	209,09	318,18
2420 811 13XX	Alessa 3M Çerçeve - Siyah Fonlu	20	-	240,91	363,64
2420 811 14XX	Alessa 4M Çerçeve - Siyah Fonlu	10	-	300,00	409,09
2420 811 17XX	Alessa 7M Çerçeve - Siyah Fonlu	10	-	363,64	500,00
2450 811 12XX	Alessa Plus 2x2M Çerçeve - Siyah Fonlu	10	-	366,76	636,36
2450 811 13XX	Alessa Plus 3x2M Çerçeve - Siyah Fonlu	10	-	504,02	818,18



Buat Kasa



Karkas



2M Modül



1M Modül



Dekoratif Çerçeve



MODÜLLER

Kod	Ürün Tanımı	Kutu Adedi	Koli Adedi	Fiyat (₺)
2400 701 0200	Anahtar (1M)	20	120	227,27
2400 703 0200	Vavien (1M)	20	120	227,27
2400 708 0200	Ara Vavien(Deviatör)(Permütatör)(1M)	20	120	363,64
2400 705 0200	Çift Kutuplu Anahtar (1M)	20	120	354,55
2400 707 0200	Light Butonu (1M)	20	120	250,00
2400 707 0200Z	Zil Butonu (1M)	20	120	250,00
2400 707 0200K	Kapı Otomatiği (1M)	20	120	250,00
YENİ 2400 706 0200	Stor/Panjur (Jaluzi - Yaylı) (1M)	20	120	545,45
YENİ 2400 436 0200	Stor/Panjur (Jaluzi - Yaysız) (1M)	20	120	545,45

Kod	Ürün Tanımı	Kutu Adedi	Koli Adedi	Beyaz/Krem Fiyat (₺)	Renkli Fiyat (₺)
YENİ 2400 472 02XX	DND/MUR Anahtar Modül + Tuş (2M)	10	60	863,64	1.000,00

Kod	Ürün Tanımı	Kutu Adedi	Koli Adedi	Beyaz/Krem Fiyat (₺)	Renkli Fiyat (₺)
2400 900 02XX	Topraklı Priz (2M)	10	60	250,00	363,64
2400 905 02XX	Topraklı Priz (Çocuk Korumalı) (2M)	10	60	272,73	409,09
2400 910 02XX	Kapaklı Topraklı Priz (2M)	10	60	272,73	431,82
2400 911 02XX	Kapaklı Topraklı Priz (Çoc.Kor.) (2M)	10	60	290,91	454,55

Kod	Ürün Tanımı	Kutu Adedi	Koli Adedi	Beyaz/Krem Fiyat (₺)	Renkli Fiyat (₺)
2400 916 02XX	Ups (Fransız) Priz (Çoc. Kor.) (2M)	10	60	318,18	431,82
2400 917 02XX	Ups (Fransız) Kapaklı Priz (2M)	10	60	340,91	454,55
YENİ 2400 918 02XX	Ups (Fransız) Kapaklı Priz (Çoc. Kor.) (2M)	10	60	375,00	485,00

Kod	Ürün Tanımı	Kutu Adedi	Koli Adedi	Beyaz/Krem Fiyat (₺)	Renkli Fiyat (₺)
2400 925 02XX	Universal Priz (1M)	20	120	454,55	545,45
2400 560 02XX	Universal Priz (2M)	10	60	863,64	909,09

Kod	Ürün Tanımı	Kutu Adedi	Koli Adedi	Beyaz/Krem Fiyat (₺)	Renkli Fiyat (₺)
2400 450 02XX	Stella Energy Saver Gecikmesiz Switch 220V (2M)	6	36	1.636,36	1.800,00
2400 452 02XX	Stella Energy Saver Gecikmeli Switch 220V (2M)	6	36	1.636,36	1.800,00
2400 462 02XX	Stella Energy Saver Gecikmesiz Switch 12V (2M)	6	36	1.818,18	2.000,00
2400 464 02XX	Stella Energy Saver Gecikmeli Switch 12V (2M)	6	36	1.818,18	2.000,00
2400 466 02XX	Stella Energy Saver Gecikmesiz 13.56 RF 12V (2M)	6	36	2.045,45	2.250,00
2400 468 02XX	Stella Energy Saver Gecikmeli 13.56 RF 12V (2M)	6	36	2.045,45	2.250,00
2400 650 02XX	Alessa Energy Saver Gecikmesiz Switch 220V (2M)	6	36	1.636,36	1.800,00
2400 652 02XX	Alessa Energy Saver Gecikmeli Switch 220V (2M)	6	36	1.636,36	1.800,00
2400 662 02XX	Alessa Energy Saver Gecikmesiz Switch 12V (2M)	6	36	1.818,18	2.000,00
2400 664 02XX	Alessa Energy Saver Gecikmeli Switch 12V (2M)	6	36	1.818,18	2.000,00
2400 666 02XX	Alessa Energy Saver Gecikmesiz 13.56 RF 12V (2M)	6	36	2.045,45	2.250,00
2400 668 02XX	Alessa Energy Saver Gecikmeli 13.56 RF 12V (2M)	6	36	2.045,45	2.250,00
2400 465 0201	4 Kanallı Röle Modülü	6	36	5.227,27	-

Kod	Ürün Tanımı	Kutu Adedi	Koli Adedi	Beyaz/Krem Fiyat (₺)	Renkli Fiyat (₺)
2400 550 02XX	İngiliz Tipi Priz (2M)	10	60	704,55	810,23

Kod	Ürün Tanımı	Kutu Adedi	Koli Adedi	Beyaz/Krem Fiyat (₺)	Renkli Fiyat (₺)
2400 469 02XX	USB + Tip-C Şarj Prizi PD 20W (2M)	10	60	1.681,82	2.000,00

Kod	Ürün Tanımı	Kutu Adedi	Koli Adedi	Beyaz/Krem Fiyat (₺)	Renkli Fiyat (₺)
2400 920 02XX	İtalyan Priz (1M)	20	120	272,73	318,18





MODÜLLER

Kod	Ürün Tanımı	Kutu Adedi	Koli Adedi	Beyaz/Krem Fiyat (₺)	Renkli Fiyat (₺)
2400 441 02XX	Dimmer 100 - 500W (1M) RC	20	120	2.136,36	2.350,00
2400 541 02XX	Dimmer 100 - 500W (1M) RL	20	120	1.636,36	1.800,00



Kod	Ürün Tanımı	Kutu Adedi	Koli Adedi	Beyaz/Krem Fiyat (₺)	Renkli Fiyat (₺)
2400 442 02XX	Dimmer 100 - 500W (2M) RC	10	60	2.272,73	2.500,00
2400 542 02XX	Dimmer 100 - 500W (2M) RL	10	60	1.681,82	1.850,00



Kod	Ürün Tanımı	Kutu Adedi	Koli Adedi	Beyaz/Krem Fiyat (₺)	Renkli Fiyat (₺)
2400 171 02XX	Tv Prizi (Sonlu) (1M)	20	120	909,09	1.090,91
2400 170 02XX	Tv Prizi (Geçişli) (1M)	20	120	909,09	1.090,91



Kod	Ürün Tanımı	Kutu Adedi	Koli Adedi	Beyaz/Krem Fiyat (₺)	Renkli Fiyat (₺)
2400 172 02XX	Tv Prizi F Dişi (1M)	20	120	386,36	431,82



Kod	Ürün Tanımı	Kutu Adedi	Koli Adedi	Beyaz/Krem Fiyat (₺)	Renkli Fiyat (₺)
2400 125 02XX	Telefon Prizi (Cat3) (1M)	20	120	386,36	425,00
2400 140 02XX	Data Prizi (Cat6) (1M)	20	120	409,09	450,00
YENİ 2400 147 01XX	1 Çıkışlı Fiber Optik Priz	20	120	418,18	460,00
YENİ 2400 457 02XX	HDMI Priz	20	120	681,82	750,00



Kod	Ürün Tanımı	Kutu Adedi	Koli Adedi	Beyaz/Krem Fiyat (₺)	Renkli Fiyat (₺)
2400 482 02XX	RCA Çıkışı 2'li (1M)	20	120	363,64	386,36



Kod	Ürün Tanımı	Kutu Adedi	Koli Adedi	Beyaz/Krem Fiyat (₺)	Renkli Fiyat (₺)
2400 121 02XX	Kör Kapak (1M)	20	120	90,91	136,36



Kod	Ürün Tanımı	Kutu Adedi	Koli Adedi	Fiyat (₺)
2400 000 0001	Mavi Lamba		50	-
				136,36

TUŞLAR

Kod	Ürün Tanımı	Kutu Adedi	Koli Adedi	Beyaz/Krem Fiyat (₺)	Renkli Fiyat (₺)
2410 701 01XX	1M Anahtar Tuş	40	-	36,36	113,64
2410 701 02XX	2M Anahtar Tuş	20	-	90,91	145,45

Kod	Ürün Tanımı	Kutu Adedi	Koli Adedi	Beyaz/Krem Fiyat (₺)	Renkli Fiyat (₺)
2410 703 01XX	1M Vavien Tuş	40	-	36,36	113,64
2410 703 02XX	2M Vavien Tuş	20	-	90,91	145,45

Kod	Ürün Tanımı	Kutu Adedi	Koli Adedi	Beyaz/Krem Fiyat (₺)	Renkli Fiyat (₺)
2410 708 01XX	1M Ara Vavien Tuş	40	-	36,36	113,64
2410 708 02XX	2M Ara Vavien Tuş	20	-	90,91	145,45

Kod	Ürün Tanımı	Kutu Adedi	Koli Adedi	Beyaz/Krem Fiyat (₺)	Renkli Fiyat (₺)
2410 707 01XX	1M Çağırma Light Tuş	40	-	36,36	113,64
2410 707 02XX	2M Çağırma Light Tuş	20	-	90,91	145,45

Kod	Ürün Tanımı	Kutu Adedi	Koli Adedi	Beyaz/Krem Fiyat (₺)	Renkli Fiyat (₺)
2410 707 01XXZ	1M Zil Anahtar Tuş	40	-	36,36	113,64
2410 707 02XXZ	2M Zil Anahtar Tuş	20	-	90,91	145,45

Kod	Ürün Tanımı	Kutu Adedi	Koli Adedi	Beyaz/Krem Fiyat (₺)	Renkli Fiyat (₺)
2410 707 01XXX	1M Kapı Otomatığı Tuş	40	-	36,36	113,64
2410 707 02XXX	2M Kapı Otomatığı Tuş	20	-	90,91	145,45

Kod	Ürün Tanımı	Kutu Adedi	Koli Adedi	Beyaz/Krem Fiyat (₺)	Renkli Fiyat (₺)
2410 715 01XX	1M Işıklı Anahtar Tuş	40	-	36,36	113,64
2410 715 02XX	2M Işıklı Anahtar Tuş	20	-	90,91	145,45

Kod	Ürün Tanımı	Kutu Adedi	Koli Adedi	Beyaz/Krem Fiyat (₺)	Renkli Fiyat (₺)
2410 716 01XX	1M Işıklı Vavien Anahtar Tuş	40	-	36,36	113,64
2410 716 02XX	2M Işıklı Vavien Anahtar Tuş	20	-	90,91	145,45

Kod	Ürün Tanımı	Kutu Adedi	Koli Adedi	Beyaz/Krem Fiyat (₺)	Renkli Fiyat (₺)
2410 717 01XX	1M Çağırma Light Işıklı Tuş	40	-	36,36	113,64
2410 717 02XX	2M Çağırma Light Işıklı Tuş	20	-	90,91	145,45

Kod	Ürün Tanımı	Kutu Adedi	Koli Adedi	Beyaz/Krem Fiyat (₺)	Renkli Fiyat (₺)
2410 717 01XXZ	1M Işıklı Zil Anahtar Tuş	40	-	36,36	113,64
2410 717 02XXZ	2M Işıklı Zil Anahtar Tuş	20	-	90,91	145,45

Kod	Ürün Tanımı	Kutu Adedi	Koli Adedi	Beyaz/Krem Fiyat (₺)	Renkli Fiyat (₺)
2410 717 01XXX	1M Işıklı Kapı Anahtar Tuş	40	-	36,36	113,64
2410 717 02XXX	2M Işıklı Kapı Anahtar Tuş	20	-	90,91	145,45

Kod	Ürün Tanımı	Kutu Adedi	Koli Adedi	Beyaz/Krem Fiyat (₺)	Renkli Fiyat (₺)
2410 706 01XX	1M Jaluzi Tuş	40	-	36,36	113,64





KARKASLAR

Kod	Ürün Tanımı	Kutu Adedi	Koli Adedi	Fiyat (₺)
2400 500 0217	Karkas (2M)	10	-	113,64
2400 500 0317	Karkas (3M)	10	-	136,36
2400 500 0417	Karkas(4M)	10	-	145,45
2400 500 0717	Karkas (7M)	10	-	204,55



SIVA ALTI BUAT KASALAR

Kod	Ürün Tanımı	Kutu Adedi	Koli Adedi	Fiyat (₺)
001 046 180101 00 12	Çift Kilitlemeli Geçmeli Derin Kasa (2M)	300	-	38,64
2400 812 1315	Sıva Altı Buat Kasa (3M)	165	-	76,07
2400 812 1415	Sıva Altı Buat Kasa (4M)	135	-	106,02
2400 812 1715	Sıva Altı Buat Kasa (7M)	90	-	135,90

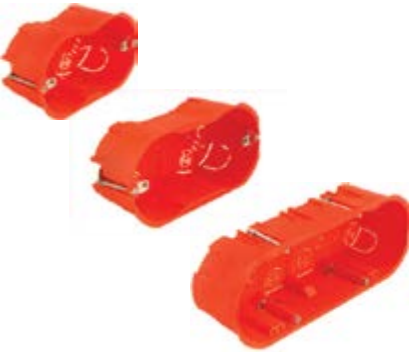

ALÇIPAN KASA

Kod	Ürün Tanımı	Kutu Adedi	Koli Adedi	Fiyat (₺)
2400 813 1312	Alçıpan Kasa (3M)	180	-	136,36
2400 813 1412	Alçıpan Kasa (4M)	150	-	172,73
2400 813 1712	Alçıpan Kasa (7M)	114	-	286,36



SIVA ALTI BAĞLANTI APARATI

Kod	Ürün Tanımı	Kutu Adedi	Koli Adedi	Fiyat (₺)
2400 818 0011	Sıva Altı Bağlantı Aparatı	40	-	30,14

YENİ

Rita
Premium

Mekandaki
Şık Detay...



Farklı renk ve yüzey seçeneklerine sahip
Rita Premium Pleksi ve Alüminyum çerçeveler,
her mekâna estetik, her detaya değer katar.





Altın
80



Bronz
87

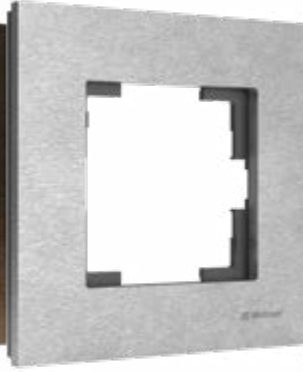

Gümüş
92



Siyah
84

ALÜMİNYUM ÇERÇEVELER



Kod	Ürün Tanımı	Kutu Adedi	Fiyat (₺)
2225 800 11XX	Tekli Çerçeve	10	852,27
2225 800 12XX	Yatay İkili Çerçeve	10	1.136,36
2225 800 13XX	Yatay Üçlü Çerçeve	10	1.846,59
2225 800 14XX	Yatay Dörtlü Çerçeve	10	2.556,82
2225 800 15XX	Yatay Beşli Çerçeve	10	3.409,09
2225 800 22XX	Dikey İkili Çerçeve	10	1.136,36
2225 800 23XX	Dikey Üçlü Çerçeve	10	1.846,59
2225 800 24XX	Dikey Dörtlü Çerçeve	10	2.556,82
2225 800 25XX	Dikey Beşli Çerçeve	10	3.409,09



Beyaz
20



Siyah
21



Antrasit
22



Kese Kağıdı
23

PLEKSİ ÇERÇEVELER



Kod	Ürün Tanımı	Kutu Adedi	Fiyat (₺)
2222 800 11XX	Tekli Çerçeve	10	681,82
2222 800 12XX	Yatay İkili Çerçeve	10	909,09
2222 800 13XX	Yatay Üçlü Çerçeve	10	1.477,27
2222 800 14XX	Yatay Dörtlü Çerçeve	10	2.045,45
2222 800 15XX	Yatay Beşli Çerçeve	10	2.727,27
2222 800 22XX	Dikey İkili Çerçeve	10	909,09
2222 800 23XX	Dikey Üçlü Çerçeve	10	1.477,27
2222 800 24XX	Dikey Dörtlü Çerçeve	10	2.045,45
2222 800 25XX	Dikey Beşli Çerçeve	10	2.727,27

Rit 

RİTA ANAHTAR PRİZ SERİSİ, MODERN İZGİLERİ VE ZARİF RENK SEENEKLERİYLE MEK NLARA ESTETİK BİR DOKUNUŐ KATAR. ŐIKLIK VE FONKSİYON TEK TASARIMDA BULUŐUR.



MODERN TASARIMLAR
KUSURSUZ ÖZÜMLER



ANAHTAR GRUBU - VİDALI TİP



2220 401 02XX
Anahtar



2220 402 02XX
Komütatör



2220 403 02XX
Vavien (İki yöllü anahtar)



2220 404 02XX
Komütatör Vavien



2220 405 02XX
Çift Kutuplu Anahtar



2220 406 02XX
Jaluzi Anahtar



2220 407 02XX
Çağırma



2220 407 02XXK
Kapı Otomatığı



2220 407 02XXZ
Zil Anahtar



2220 408 02XX
Deviyatör (Ara Vavien)



2220 409 02XX
Üçlü Anahtar



2220 411 02XX
Şofben Anahtar



2220 415 02XX
Işıklı Anahtar (220V)



2220 416 02XX
Işıklı Vavien (220V)



2220 417 02XX
Işıklı Çağırma (220V)



2220 418 02XX
Işıklı Etiketli Anahtar (220V)



2220 419 02XX
Işıklı Etiketli Çağırma (220V)



2220 422 02XX
Işıklı Zil Etiketli Çağırma (12V)



2220 425 02XX
Tek Tuşlu Jaluzi Anahtar

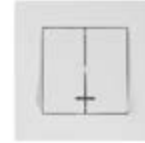

2220 426 02XX
Işıklı Komitatör



2220 436 02XX
Tek Tuşlu Jaluzi Anahtar (Yaysız-Vidalı)

ANAHTAR GRUBU - KLİPSLİ TİP (KOLAY BAĞLANTI)



2220 401 01XX
Anahtar



2220 402 01XX
Komütatör



2220 403 01XX
Vavien (İki yöllü anahtar)



2220 404 01XX
Komütatör Vavien

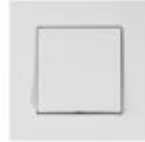

2220 405 01XX
Çift Kutuplu Anahtar



2220 406 01XX
Jaluzi Anahtar



2220 407 01XX
Çağırma



2220 407 01XXK
Kapı Otomatığı



2220 407 01XXZ
Zil Anahtar



2220 408 01XX
Deviyatör (Ara Vavien)



2220 409 01XX
Üçlü Anahtar



2220 415 01XX
Işıklı Anahtar (220V)



2220 416 01XX
Işıklı Vavien (220V)



2220 417 01XX
Işıklı Çağırma (220V)



2220 418 01XX
Işıklı Etiketli Anahtar (220V)



2220 419 01XX
Işıklı Etiketli Çağırma (220V)



2220 422 01XX
Işıklı Zil Etiketli Çağırma (12V)



2220 426 01XX
Işıklı Komitatör



2220 436 01XX
Tek Tuşlu Jaluzi Anahtar (Yaysız-Vidalı)

ELEKTRONİK GRUBU



2220 250 01XX
Speakhone Prizi



2220 251 01XX
RCA Prizi



2220 252 01XX
3,5 Ses Jakı



2220 253 01XX
XLR Erkek Prizi



2220 254 01XX
XLR Dişi Prizi



2220 255 01XX
USB Priter Prizi



2220 450 01XX
Energy Saver Gecikmesiz Işıklı



2220 452 01XX
Energy Saver Gecikmeli Işıklı



2220 454 01XX
Temassız Anahtar



2220 470 02XX
Müzik Yayın Anahtar



2220 480 01XX
Hoparlör Prizi



2220 485 02XX
Uyarı Zili



2220 495 02XX
Hareket Sensörü

PRİZ GRUBU



2220 600 02XX
Topraklı Priz



2220 601 02XX
Topraksız Priz



2220 605 02XX
Topraklı Priz (Ç.K)



2220 606 02XX
Topraksız Priz (Ç.K)



2220 610 02XX
Kapaklı Topraklı Priz



2220 611 02XX
Kapaklı Topraklı Priz (Ç.K)



2220 615 02XX
Ups (Fransız) Prizi



2220 616 02XX
Ups (Fransız) Prizi (Ç.K)



2220 617 02XX
Ups Kapaklı (Fransız) Prizi



2220 618 02XX
Ups Kapaklı (Fransız) Prizi (Ç.K)



2220 448 01XX
Tekli USB Şarj Prizi



2220 469 01XX
İkili USB Şarj Prizi



2220 200 02XX
İkili Topraklı Priz Porselen



2220 201 02XX
İkili Topraksız Priz Porselen



2220 202 02XX
İkili Topraklı Priz



2220 203 02XX
İkili Topraksız Priz



2220 215 01XX
İkili UPS Priz



2220 629 02XX
Usb + Type C Topraklı Priz

İLETİŞİM GRUBU



2220 125 01XX
Telefon Prizi 1XRj11 (Cat3)



2220 126 01XX
Telefon Prizi 2XRj11 (Cat3)



2220 128 01XX
Etiketli Telefon Data Prizi (Konnektörsüz)



2220 135 01XX
Data Prizi 1*Rj45 (Konnektörsüz)



2220 136 01XX
Data Prizi 1*Rj45 (Cat5e)



2220 137 01XX
Data Prizi 2*Rj45 (Konnektörsüz)



2220 138 01XX
Data Prizi 2*Rj45 (Cat5e)



2220 139 01XX
Telefon Data Prizi (Rj11 Cat3 + Cat5e)



2220 140 01XX
Data Prizi 1*Rj45 (Cat6)



2220 141 01XX
Data Prizi 2*Rj45 (Cat6)



2220 142 01XX
Telefon Data Prizi Rj45 (Cat6)



2220 455 01XX
1*USB Prizi



2220 456 01XX
2*USB Prizi



2220 457 01XX
1*HDMI Prizi



2220 458 01XX
2*HDMI Priz



2220 459 01XX
1*USB/1 HDMI Priz



2220 460 01XX
VGA Priz



2220 147 01XX
Tek Çıkışlı Fiber Optik Priz



2220 461 01XX
İki Çıkışlı Fiber Optik Priz



2220 121 02XX
Kör Kapak

TV-SAT GRUBU



2220 156 02XX
Tv-Sat Prizi (Geçişli) 4DB/F Konnektörlü



2220 157 02XX
Tv-Sat Prizi (Sonlu)



2220 166 01XX
Sat Prizi (Geçişli) 4DB/F Konnektörlü



2220 167 01XX
Sat Prizi (Sonlu)



2220 440 02XX
RL Işıklı Dimmer 600W



2220 444 02XX
RL Işıklı Dimmer 1000W



2220 447 02XX
RC Dimmer 325W



2220 170 01XX
Tv Prizi (Geçişli) 11DB



2220 171 01XX
Tv Prizi (Sonlu)



2220 172 01XX
Tv Prizi F Dişi



2220 122 02XX
Kablo Çıkışı

YENİ

DİMMER GRUBU



NATURAL



01 - BEYAZ



02 - KREM

AHŞAP



56 - KIRAZ



57 - CEVİZ



58 - MEŞE

METALİK



80 - A.ALTIN



82 - İNOX



83 - TİTANYUM



84 - SİYAH



85 - DORE



86 - ANTRASİT



95 - FÜME

Kod	Ürün Tanımı	Kutu Adedi	Koli Adedi	Beyaz/Krem Fiyat (₺)	Metalik Fiyat (₺)	Ahşap Fiyat (₺)
Anahtar Grubu - Vidalı Tip						
2200 401 02XX	Mek+Tuş Anahtar (Vidalı)	12	120	163,64	227,27	250,00
2200 402 02XX	Mek+Tuş Komütatör (Vidalı)	12	120	207,95	277,27	305,00
2200 403 02XX	Mek+Tuş Vavien (İki Yollu Anahtar)(Vidalı)	12	120	200,00	268,18	295,00
2200 404 02XX	Mek+Tuş Komütatör Vavien (Vidalı)	12	120	348,18	454,55	500,00
2200 405 02XX	Mek+Tuş Çift Kutuplu Anahtar (Vidalı)	12	120	231,82	295,45	325,00
2200 406 02XX	Mek+Tuş Jaluzi Anahtar (Vidalı)	12	120	350,00	400,00	440,00
2200 407 02XX	Mek+Tuş Çağırma (Vidalı)	12	120	177,27	236,36	260,00
2200 407 02XXX	Mek+Tuş Kapı Otomatığı Anahtar (Vidalı)	12	120	177,27	236,36	260,00
2200 407 02XXZ	Mek+Tuş Zil Anahtar (Vidalı)	12	120	177,27	236,36	260,00
2200 408 02XX	Mek+Tuş Deviatör(Ara Vavien)(Vidalı)	12	120	385,00	409,09	450,00
2200 409 02XX	Mek+Tuş Üçlü Anahtar (Vidalı)	12	120	340,00	431,82	475,00
YENİ 2200 410 02XX	Mek+Tuş DND Komütatör Anahtar (Vidalı)	12	120	363,64	409,09	449,90
2200 411 02XX	Mek+Tuş Şofben Anahtar (Vidalı)	12	120	277,27	361,74	397,92
2200 415 02XX	Mek+Tuş Işıklı Anahtar (220V) (Vidalı)	12	120	275,00	363,64	400,00
2200 416 02XX	Mek+Tuş Işıklı Vavien (220V) (Vidalı)	12	120	340,00	418,18	460,00
2200 417 02XX	Mek+Tuş Işıklı Çağırma (220V)(Vidalı)	12	120	275,00	390,91	430,00
2200 418 02XX	Mek+Tuş Işıklı Etik. Anahtar (220V)(Vidalı)	12	120	306,00	340,91	375,00
2200 419 02XX	Mek+Tuş Işıklı Etik. Çağırma (220V)(Vidalı)	12	120	304,00	409,09	450,00
2200 422 02XX	Mek+Tuş Işıklı Zil Etik. Çağırma (12V)(Vidalı)	12	120	381,82	454,55	500,00
2200 425 02XX	Mek+Tuş Tek Tuşlu Jaluzi Anahtar (Vidalı)	12	120	340,91	404,57	445,02
2200 426 02XX	Mek+Tuş Işıklı Komütatör (Vidalı)	12	120	363,64	386,36	425,00
2200 436 02XX	Mek+Tuş Jaluzi Anahtar (Yaysız)(Vidalı)	12	120	340,00	404,55	445,00



* Çoklu çerçeve ile kullanılamaz.

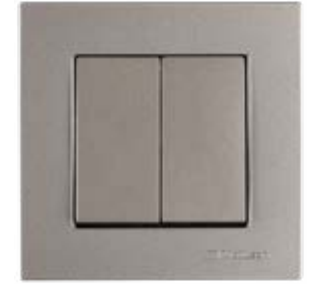

ANAHTAR PRİZ GRUBU

Anahtar Grubu Klipsli Tip (Kolay Bağlantı)

2200 401 01XX	Mek+Tuş Anahtar (Klipsli)	12	120	163,64	227,27	250,00
2200 402 01XX	Mek+Tuş Komütatör (Klipsli)	12	120	207,95	277,27	305,00
2200 403 01XX	Mek+Tuş Vavien (İki Yollu Anahtar)(Klipsli)	12	120	200,00	268,18	295,00
2200 404 01XX	Mek+Tuş Komütatör Vavien (Klipsli)	12	120	348,18	454,55	500,00
2200 405 01XX	Mek+Tuş Çift Kutuplu Anahtar (Klipsli)	12	120	231,82	295,45	325,00
2200 406 01XX	Mek+Tuş Jaluzi Anahtar (Klipsli)	12	120	350,00	400,00	440,00
2200 407 01XX	Mek+Tuş Çağırma (Klipsli)	12	120	177,27	236,36	260,00
2200 407 01XXX	Mek+Tuş Kapı Otomatığı Anahtar (Klipsli)	12	120	177,27	236,36	260,00
2200 407 01XXZ	Mek+Tuş Zil Anahtar (Klipsli)	12	120	177,27	236,36	260,00
2200 408 01XX	Mek+Tuş Deviatör(Ara Vavien)(Klipsli)	12	120	385,00	409,09	450,00
2200 409 01XX	Mek+Tuş Üçlü Anahtar (Klipsli)	12	120	340,00	431,82	475,00
YENİ 2200 410 01XX	Mek+Tuş DND Komütatör Anahtar (Klipsli)	12	120	363,64	409,09	449,90
2200 415 01XX	Mek+Tuş Işıklı Anahtar (220V) (Klipsli)	12	120	275,00	363,64	400,00
2200 416 01XX	Mek+Tuş Işıklı Vavien (220V) (Klipsli)	12	120	340,00	418,18	460,00
2200 417 01XX	Mek+Tuş Işıklı Çağırma (220V)(Klipsli)	12	120	275,00	390,91	430,00
2200 418 01XX	Mek+Tuş Işıklı Etik. Anahtar (220V)(Klipsli)	12	120	306,00	340,91	375,00
2200 419 01XX	Mek+Tuş Işıklı Etik. Çağırma (220V)(Klipsli)	12	120	304,00	409,09	450,00
2200 422 01XX	Mek+Tuş Işıklı Zil Etik. Çağırma (12V)(Klipsli)	12	120	381,82	454,55	500,00
2200 426 01XX	Mek+Tuş Işıklı Komütatör (Klipsli)	12	120	363,64	386,36	425,00
2200 436 01XX	Mek+Tuş Jaluzi Anahtar (Yaysız)(Klipsli)	12	120	340,00	404,55	445,00

Dimmer Grubu

2200 440 02XX	Mek+Tuş RL Işıklı Dimmer 600W	8	80	909,09	1.000,00	1.100,00
2200 444 02XX	Mek+Tuş RL Işıklı Dimmer 1000W	8	80	1.000,00	1.090,91	1.200,00
2200 447 02XX	Mek+Tuş RC Dimmer 325W	8	80	1.818,18	2.500,00	2.750,00

Kod	Ürün Tanımı	Kutu Adedi	Koli Adedi	Beyaz/Krem Fiyat (₺)	Metalik Fiyat (₺)	Ahşap Fiyat (₺)
İletişim Grubu						
2200 125 01XX	Mek+Tuş Telefon Prizi 1XRj11 (Cat3)	12	120	190,91	304,55	335,00
2200 126 01XX	Mek+Tuş Telefon Prizi 2XRj11 (Cat3)	12	120	318,18	440,91	485,00
2200 128 01XX	Mek+Tuş Etiketli Tlf Data Priz (Kon.süz)	12	120	136,36	197,73	217,50
2200 135 01XX	Mek+Tuş Data Prizi 1*Rj45 (Kon.süz)	12	120	136,36	177,95	195,75
2200 136 01XX	Mek+Tuş Data Prizi 1*Rj45 (Cat5e)	12	120	500,00	590,91	650,00
2200 137 01XX	Mek+Tuş Data Prizi 2*Rj45 (Kon.süz)	12	120	145,45	184,55	203,00
2200 138 01XX	Mek+Tuş Data Prizi 2*Rj45 (Cat5e)	12	120	727,27	818,18	900,00
2200 139 01XX	Mek+Tuş Tlf Data Priz (Rj11 Cat3 + Cat5e)	12	120	590,91	750,00	825,00
2200 140 01XX	Mek+Tuş Data Prizi 1*Rj45 (Cat6)	12	120	500,00	590,91	650,00
2200 141 01XX	Mek+Tuş Data Prizi 2*Rj45 (Cat6)	12	120	727,27	818,18	900,00
2200 142 01XX	Mek+Tuş Tlf Data Priz (Rj45 Cat6)	12	120	590,91	750,00	825,00
2200 455 01XX	Mek+Tuş 1*USB Priz	12	120	423,79	527,27	580,00
2200 456 01XX	Mek+Tuş 2*USB Priz	12	120	723,12	922,73	1.015,00
2200 457 01XX	Mek+Tuş 1*HDMI Priz	12	120	563,06	725,00	797,50
2200 458 01XX	Mek+Tuş 2*HDMI Priz	12	120	1.016,90	1.285,23	1.413,75
2200 459 01XX	Mek+Tuş 1*USB/1*HDMI Priz	12	120	1.152,03	1.515,91	1.667,50
2200 460 01XX	Mek+Tuş VGA Priz	12	120	1.208,93	1.515,91	1.667,50
2200 147 01XX	Mek+Tuş Bir Çıkışlı Fiber Optik Priz (Rj45)	12	120	280,57	409,09	450,00
2200 461 01XX	Mek+Tuş İki Çıkışlı Fiber Optik Priz	12	120	423,83	593,18	652,50
2200 121 02XX	Mek+Tuş Kör Kapak	12	120	92,65	159,09	175,00

Priz Grubu

2200 600 02XX	Mek+Tuş Topraklı Priz	12	120	190,91	272,73	300,00
2200 601 02XX	Mek+Tuş Topraksız Priz	12	120	172,73	245,45	270,00
2200 605 02XX	Mek+Tuş Topraklı Priz (Ç.K.)	12	120	245,45	363,64	400,00
2200 606 02XX	Mek+Tuş Topraksız Priz (Ç.K.)	12	120	218,18	286,36	315,00
2200 610 02XX	Mek+Tuş Kapaklı Topraklı Priz	12	120	226,26	300,00	330,00
2200 611 02XX	Mek+Tuş Kapaklı Topraklı Priz (Ç.K.)	12	120	250,00	431,82	475,00
2200 615 02XX	Mek+Tuş Ups (Fransız) Prizi	12	120	248,33	359,09	395,00
2200 616 02XX	Mek+Tuş Ups (Fransız) Prizi (Ç.K.)	12	120	269,64	409,09	450,00
2200 617 02XX	Mek+Tuş Ups Kapaklı (Fransız) Priz	12	120	264,21	363,64	400,00
2200 618 02XX	Mek+Tuş Ups Kapaklı (Fr.) Priz (Ç.K.)	12	120	287,58	431,82	475,00
2200 200 02XX	Mek+Tuş İkilili Topraklı Priz Porselen	5	50	431,82	545,45	600,00
2200 201 02XX	Mek+Tuş İkilili Topraksız Priz Porselen	5	50	363,64	409,09	450,00
2200 202 02XX	Mek+Tuş İkilili Topraklı Priz	5	50	345,45	409,09	450,00
2200 203 02XX	Mek+Tuş İkilili Topraksız Priz	5	50	295,45	340,91	375,00
2200 215 02XX	Mek+Tuş İkilili Ups Priz	5	50	340,91	431,82	475,00
2200 448 01XX	Mek+Tuş Tekli Usb Şarj Prizi	5	50	590,52	750,00	825,00
2200 469 01XX	Mek+Tuş İkilili Usb + Type-C Şarj Prizi	5	50	750,00	863,64	950,00
2220 629 02XX	Ritü Usb + Tip-C İli Topraklı Priz (Çerçeve Dahil)	8	-	909,09	1.363,64	1.500,00



Kod	Ürün Tanımı	Kutu Adedi	Koli Adedi	Beyaz/Krem Fiyat (₺)	Metalik Fiyat (₺)	Ahşap Fiyat (₺)
TV / SAT Grubu						
2200 156 02XX	Mek+Tuş Tv-Sat Prizi (Geçişli) 4DB/F Kon.	12	120	863,64	1.090,91	1.200,00
2200 157 02XX	Mek+Tuş Tv-Sat Prizi (Sonlu)	12	120	863,64	1.090,91	1.200,00
2200 166 01XX	Mek+Tuş Sat Prizi (Geçişli) 4DB/F Kon.	12	120	795,45	909,09	1.000,00
2200 167 01XX	Mek+Tuş Sat Prizi (Sonlu)	12	120	795,45	909,09	1.000,00
2200 170 01XX	Mek+Tuş Tv Prizi (Geçişli) 11DB	12	120	272,73	318,18	350,00
2200 171 01XX	Mek+Tuş Tv Prizi (Sonlu)	12	120	272,73	318,18	350,00
2200 172 01XX	Mek+Tuş Tv Prizi F Dişi	12	120	204,55	272,73	300,00
YENİ 2200 122 01XX	Mek+Tuş Kablo Çıkışı	12	120	116,57	147,35	162,09

Elektronik Grubu

2200 450 01XX	Mek+Tuş Energy Saver Gecikmesiz Işıklı	8	80	1.000,00	1.212,25	1.333,48
2200 452 01XX	Mek+Tuş Energy Saver Gecikmeli Işıklı	8	80	1.000,00	1.276,05	1.403,66
2200 454 01XX	Mek+Tuş Temassız	12	120	2.355,77	2.500,00	2.750,00
2200 470 02XX	Mek+Tuş Müzik Yayın Anahtarı	8	80	1.422,09	1.515,01	1.666,51
2200 480 01XX	Mek+Tuş Hoparlör Prizi	8	80	278,57	403,91	444,30
2200 485 02XX	Mek+Tuş Uyanı Zili	8	80	2.135,09	2.329,15	2.562,06
2200 495 02XX	Mek+Tuş Hareket Sensörü	8	80	2.045,45	2.144,75	2.359,22
2200 250 01XX	Mek+Tuş Speakhone Prizi	12	120	MÜŞTERİ TEMSİLCİSİNE FİYAT SORUNUZ		
2200 251 01XX	Mek+Tuş RCA Prizi	12	120			
2200 252 01XX	Mek+Tuş 3,5 Ses Jakı	12	120			
2200 253 01XX	Mek+Tuş XLR Erkek Prizi	12	120			
2200 254 01XX	Mek+Tuş XLR Dişi Prizi	12	120			
2200 255 01XX	Mek+Tuş Usb Printer Prizi	12	120			

Çerçeveler

2220 800 11XX	Tekli Çerçeve	20	400	21,59	86,36	95,00
2220 800 12XX	İkili Yatay Çerçeve	10	200	122,73	181,82	200,00
2220 800 13XX	Üçlü Yatay Çerçeve	10	50	159,09	250,00	275,00
2220 800 14XX	Dörtlü Yatay Çerçeve	10	50	195,45	318,18	350,00
2220 800 15XX	Beşli Yatay Çerçeve	10	50	245,45	386,36	425,00
2220 800 16XX	Altılı Yatay Çerçeve	10	50	295,45	454,55	500,00
2220 800 22XX	İkili Dikey Çerçeve	10	50	122,73	181,82	200,00
2220 800 23XX	Üçlü Dikey Çerçeve	10	50	159,09	250,00	275,00
2220 800 24XX	Dörtlü Dikey Çerçeve	10	50	195,45	318,18	350,00
2220 800 25XX	Beşli Dikey Çerçeve	10	50	245,45	386,36	425,00
2220 800 26XX	Altılı Dikey Çerçeve	10	50	295,45	454,55	500,00
2220 820 12XX	İkili Priz Çerçeve	12	60	86,36	136,36	150,00
2200 000 11XX	Sıva Üstü Anahtar Kasası (Geçmeli)	-	-	125,00	172,73	190,00
2200 800 00XX	Telefon Tutucu	24	240	45,45	-	-
2200 000 0001	IP44 Kapaklı Priz Conta	24	120	45,45	-	-



Elitra | Plus

ELİTRA SERİSİ, CAM, AHŞAP VE ALÜMİNYUM ÇERÇEVE SEÇENEKLERİYLE MEKÂNIN KARAKTERİNE KUSURSUZCA UYUM SAĞLAR. SEÇKİN MALZEME YAPISI VE RAFİNE TASARIMIYLA ANAHTAR PRİZLERDE ÜST SEGMENT BİR DENEYİM SUNAR.



UYUM VE ZARAFET

BİR ARADA...



Elitra | Plus

Elitra Glass BEYAZ / SİYAH ÇERÇEVELER - CAM

Kod	Ürün Tanımı	Kutu Adedi	Fiyat (₺)
2170 XXX 11XX	Tekli Çerçeve	10	643,53
2170 XXX 12XX	Yatay İkili Çerçeve	10	1.507,71
2170 XXX 13XX	Yatay Üçlü Çerçeve	10	2.539,02
2170 XXX 14XX	Yatay Dörtlü Çerçeve	10	2.864,48
2170 XXX 15XX	Yatay Beşli Çerçeve	10	4.303,67
2170 XXX 22XX	Dikey İkili Çerçeve	10	1.507,71
2170 XXX 23XX	Dikey Üçlü Çerçeve	10	2.539,02
2170 XXX 24XX	Dikey Dörtlü Çerçeve	10	2.864,48
2170 XXX 25XX	Dikey Beşli Çerçeve	10	4.303,67

XXX-811



XXX-814

Beyaz
 Gümüş
 XX-01 XX-92

Elitra Chrome KROM / PASLANMAZ ÇELİK / ALTIN ÇERÇEVELER

Kod	Ürün Tanımı	Kutu Adedi	Fiyat (₺)
2170 XXX 1190	Tekli Çerçeve	10	1.259,57
2170 XXX 1290	Yatay İkili Çerçeve	10	1.993,87
2170 XXX 1390	Yatay Üçlü Çerçeve	10	2.640,12
2170 XXX 1490	Yatay Dörtlü Çerçeve	10	2.967,25
2170 XXX 1590	Yatay Beşli Çerçeve	10	3.677,90
2170 XXX 1690	Yatay Altılı Çerçeve	10	4.869,43
2170 XXX 2290	Dikey İkili Çerçeve	10	1.993,87
2170 XXX 2390	Dikey Üçlü Çerçeve	10	2.640,12
2170 XXX 2490	Dikey Dörtlü Çerçeve	10	2.967,25
2170 XXX 2590	Dikey Beşli Çerçeve	10	3.677,90
2170 XXX 2690	Dikey Altılı Çerçeve	10	4.869,43

XXX-821



XXX-822

XXX-824

Elitra Chrome GÜMÜŞ - PARLAK FÜME ÇERÇEVELER

Kod	Ürün Tanımı	Kutu Adedi	Fiyat (₺)
2170 825 1192	Tekli Çerçeve	10	1.053,67
2170 825 1292	Yatay İkili Çerçeve	10	1.843,10
2170 825 1392	Yatay Üçlü Çerçeve	10	2.618,06
2170 825 1492	Yatay Dörtlü Çerçeve	10	3.238,71
2170 825 1592	Yatay Beşli Çerçeve	10	3.686,09
2170 825 1692	Yatay Altılı Çerçeve	10	4.281,20
2170 825 2292	Dikey İkili Çerçeve	10	1.843,10
2170 825 2392	Dikey Üçlü Çerçeve	10	2.618,06
2170 825 2492	Dikey Dörtlü Çerçeve	10	3.238,71
2170 825 2592	Dikey Beşli Çerçeve	10	3.686,09
2170 825 2692	Dikey Altılı Çerçeve	10	4.281,20

XXX-825



XXX-825

XXX-827



XXX-828



XXX-832

XXX-833

XXX-834

Gümüş
XX-92

Saten
XX-90



XXX-842

XXX-843

Gümüş
XX-92



XXX-851

XXX-852

XXX-853

Gümüş
XX-92

Saten
XX-90

Füme
XX-95

Elitra Chrome

MAT ALÜMİNYUM - MAT SATEN ÇERÇEVELER

Kod	Ürün Tanımı	Kutu Adedi	Fiyat (₺)
2170 XXX 1195	Tekli Çerçeve	10	990,94
2170 XXX 1295	Yatay İkili Çerçeve	10	1.551,87
2170 XXX 1395	Yatay Üçlü Çerçeve	10	2.055,57
2170 XXX 1495	Yatay Dörtlü Çerçeve	10	2.528,08
2170 XXX 1595	Yatay Beşli Çerçeve	10	3.196,01
2170 XXX 1695	Yatay Altılı Çerçeve	10	4.263,90
2170 XXX 2295	Dikey İkili Çerçeve	10	1.551,87
2170 XXX 2395	Dikey Üçlü Çerçeve	10	2.055,57
2170 XXX 2495	Dikey Dörtlü Çerçeve	10	2.528,08
2170 XXX 2595	Dikey Beşli Çerçeve	10	3.196,01
2170 XXX 2695	Dikey Altılı Çerçeve	10	4.263,90

Elitra Wood

KAYIN / KIRAZ / VENGE ÇERÇEVELER

Kod	Ürün Tanımı	Kutu Adedi	Fiyat (₺)
2170 XXX 11XX	Tekli Çerçeve	10	958,99
2170 XXX 12XX	Yatay İkili Çerçeve	10	1.543,76
2170 XXX 13XX	Yatay Üçlü Çerçeve	10	2.228,84
2170 XXX 14XX	Yatay Dörtlü Çerçeve	10	2.807,88
2170 XXX 15XX	Yatay Beşli Çerçeve	10	3.472,53
2170 XXX 22XX	Dikey İkili Çerçeve	10	1.543,76
2170 XXX 23XX	Dikey Üçlü Çerçeve	10	2.228,84
2170 XXX 24XX	Dikey Dörtlü Çerçeve	10	2.807,88
2170 XXX 25XX	Dikey Beşli Çerçeve	10	3.472,53

Elitra Marble

BLACK QUARTZ / SAND STONE ÇERÇEVELER

Kod	Ürün Tanımı	Kutu Adedi	Fiyat (₺)
2170 XXX 11XX	Tekli Çerçeve	10	1.163,81
2170 XXX 12XX	Yatay İkili Çerçeve	10	1.342,78
2170 XXX 13XX	Yatay Üçlü Çerçeve	10	2.047,29
2170 XXX 14XX	Yatay Dörtlü Çerçeve	10	2.665,82
2170 XXX 15XX	Yatay Beşli Çerçeve	10	3.296,29
2170 XXX 22XX	Dikey İkili Çerçeve	10	1.342,78
2170 XXX 23XX	Dikey Üçlü Çerçeve	10	2.047,29
2170 XXX 24XX	Dikey Dörtlü Çerçeve	10	2.665,82
2170 XXX 25XX	Dikey Beşli Çerçeve	10	3.296,29

Elitra Ale

NATURAL / SATEN / MAT FÜME ÇERÇEVELER

Kod	Ürün Tanımı	Kutu Adedi	Fiyat (₺)
2170 XXX 11XX	Tekli Çerçeve	10	772,57
2170 XXX 12XX	Yatay İkili Çerçeve	10	1.325,59
2170 XXX 13XX	Yatay Üçlü Çerçeve	10	2.179,01
2170 XXX 14XX	Yatay Dörtlü Çerçeve	10	2.728,54
2170 XXX 15XX	Yatay Beşli Çerçeve	10	3.372,13
2170 XXX 16XX	Yatay Altılı Çerçeve	10	6.281,23
2170 XXX 22XX	Dikey İkili Çerçeve	10	1.325,59
2170 XXX 23XX	Dikey Üçlü Çerçeve	10	2.179,01
2170 XXX 24XX	Dikey Dörtlü Çerçeve	10	2.728,54
2170 XXX 25XX	Dikey Beşli Çerçeve	10	3.372,13
2170 XXX 26XX	Dikey Altılı Çerçeve	10	6.281,23

Elitra | Plus

Mekanizma + Tuş Ürün Listesi

BEYAZ-01 / SATEN-90 / GÜMÜŞ-92 / FÜME-95

Kod	Ürün Tanımı	Kutu Adedi	Fiyat (₺)
Anahtar Grubu - Vidalı Tip			
2270 401 02XX	Mek+Tuş Anahtar	12	227,27
2270 402 02XX	Mek+Tuş Komütatör	12	277,27
2270 403 02XX	Mek+Tuş Vavien (İki Yollu Anahtar)	12	268,18
2270 404 02XX	Mek+Tuş Komütatör Vavien	12	454,55
2270 405 02XX	Mek+Tuş Çift Kutuplu Anahtar	12	295,45
2270 406 02XX	Mek+Tuş Jaluzi Anahtar-Yaylı	12	400,00
2270 407 02XX	Mek+Tuş Light (Çağırma)	12	236,36
2270 407 02XXZ	Mek+Tuş Zil Anahtarı	12	236,36
2270 407 02XXK	Mek+Tuş Kapı Otomatığı Anahtarı	12	236,36
2270 408 02XX	Mek+Tuş Deviatör (Ara Vavien)	12	409,09
2270 409 02XX	Mek+Tuş Üçlü Anahtar	12	431,82
2270 411 02XX	Mek+Tuş Şofben Anahtarı	12	361,74
2270 415 02XX	Mek+Tuş Işıklı Anahtar (220V)	12	363,64
2270 416 02XX	Mek+Tuş Işıklı Vavien (220V)	12	418,18
2270 417 02XX	Mek+Tuş Işıklı Çağırma (220V)	12	390,91
2270 418 02XX	Mek+Tuş Işıklı Etiketli Anahtar (220V)	12	340,91
2270 419 02XX	Mek+Tuş Işıklı Etiketli Çağırma (220V)	12	409,09
2270 422 02XX	Mek+Tuş Işıklı Zil Etiketli Çağırma (12V)	12	454,55
2270 426 02XX	Mek+Tuş Işıklı Komütatör	12	386,36



Anahtar Grubu - Klipsli Tip (Kolay Bağlantı)

2270 401 01XX	Mek+Tuş Anahtar	12	227,27
2270 402 01XX	Mek+Tuş Komütatör	12	277,27
2270 403 01XX	Mek+Tuş Vavien (İki Yollu Anahtar)	12	268,18
2270 404 01XX	Mek+Tuş Komütatör Vavien	12	454,55
2270 405 01XX	Mek+Tuş Çift Kutuplu Anahtar	12	295,45
2270 406 01XX	Mek+Tuş Jaluzi Anahtar-Yaylı	12	400,00
2270 407 01XX	Mek+Tuş Light (Çağırma)	12	236,36
2270 407 01XXZ	Mek+Tuş Zil Anahtarı	12	236,36
2270 407 01XXK	Mek+Tuş Kapı Otomatığı Anahtarı	12	236,36
2270 408 01XX	Mek+Tuş Deviatör (Ara Vavien)	12	409,09
2270 409 01XX	Mek+Tuş Üçlü Anahtar	12	431,82
2270 415 01XX	Mek+Tuş Işıklı Anahtar (220V)	12	363,64
2270 416 01XX	Mek+Tuş Işıklı Vavien (220V)	12	418,18
2270 417 01XX	Mek+Tuş Işıklı Çağırma (220V)	12	390,91
2270 418 01XX	Mek+Tuş Işıklı Etiketli Anahtar (220V)	12	340,91
2270 419 01XX	Mek+Tuş Işıklı Etiketli Çağırma (220V)	12	409,09
2270 422 01XX	Mek+Tuş Işıklı Zil Etiketli Çağırma (12V)	12	454,55
2270 426 01XX	Mek+Tuş Işıklı Komütatör	12	386,36



Dimmer Grubu

2270 440 02XX	Mek+Tuş Işıklı Dimmer 600W	8	1.000,00
2270 444 02XX	Mek+Tuş Işıklı Dimmer 1000W	8	1.090,91
2270 447 02XX	Mek+Tuş RC Dimmer 325W	8	2.500,00



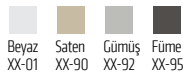

Kod	Ürün Tanımı	Kutu Adedi	Fiyat (₺)
Priz Grubu			
2270 600 02XX	Mek+Tuş Topraklı Priz	12	272,73
2270 601 02XX	Mek+Tuş Topraksız Priz	12	245,45
2270 605 02XX	Mek+Tuş Topraklı Priz (Ç.K.)	12	363,64
2270 606 02XX	Mek+Tuş Topraksız Priz (Ç.K.)	12	286,36
2270 610 02XX	Mek+Tuş Kapaklı Topraklı Priz	12	300,00
2270 611 02XX	Mek+Tuş Kapaklı Topraklı Priz (Ç.K.)	12	431,82
2270 615 02XX	Mek+Tuş Ups (Fransız) Prizi	12	359,09
2270 616 02XX	Mek+Tuş Ups (Fransız) Prizi(Ç.K.)	12	409,09
2270 617 02XX	Mek+Tuş Ups Kapaklı (Fransız) Priz	12	363,64
2270 618 02XX	Mek+Tuş Ups Kap. (Fransız) Priz (Ç.K.)	12	431,82
2270 121 01XX	Mek+Tuş Kör Kapak	12	159,09
2270 448 01XX	Mek+Tuş Tekli Usb Şarj Prizi	5	750,00

İletişim Grubu

2270 455 01XX	Mek+Tuş 1*USB Priz	12	527,27
2270 456 01XX	Mek+Tuş 2*USB Priz	12	922,73
2270 457 01XX	Mek+Tuş 1*HDMI Priz	12	725,00
2270 458 01XX	Mek+Tuş 2*HDMI Priz	12	1.285,23
2270 459 01XX	Mek+Tuş 1*USB/1*HDMI Priz	12	1.515,91
2270 125 01XX	Mek+Tuş Telefon Prizi 1*Rj11 Cat3	12	304,55
2270 126 01XX	Mek+Tuş Telefon Prizi 2*Rj11 Cat3	12	440,91
2270 128 01XX	Mek+Tuş Etiketli Tlf+Data Priz (Kon.süz)	12	197,73
2270 135 01XX	Mek+Tuş Data Prizi 1*Rj45 (Kon.süz)	12	177,95
2270 136 01XX	Mek+Tuş Data Prizi 1*Rj45 (Cat5e)	12	590,91
2270 137 01XX	Mek+Tuş Data Prizi 2*Rj45 (Kon.süz)	12	184,55
2270 138 01XX	Mek+Tuş Data Prizi 2*Rj45 (Cat5e)	12	818,18
2270 139 01XX	Mek+Tuş Tlf+Data Priz Rj11 (Cat3+Cat5e)	12	750,00
2270 140 01XX	Mek+Tuş Data Prizi 1*Rj45 (Cat6)	12	590,91
2270 141 01XX	Mek+Tuş Data Prizi 2*Rj45 (Cat6)	12	818,18
2270 147 01XX	Mek+Tuş Bir Çıkışlı Fiber Optik Priz (RJ45)	12	409,09

Elektronik Grubu

2270 450 01XX	Mek+Tuş Energy Saver Gecikmesiz Işıklı	8	1.212,25
2270 452 01XX	Mek+Tuş Energy Saver Gecikmeli	8	1.276,05
2270 470 02XX	Mek+Tuş Müzik Yayın Anahtar	8	1.515,01
2270 480 01XX	Mek+Tuş Hoparlör Prizi	8	403,91
2270 485 02XX	Mek+Tuş Uyarı Zili	8	2.329,15
2270 495 02XX	Mek+Tuş Hareket Sensörü	8	2.144,75

TV / SAT Grubu

2270 156 02XX	Mek+Tuş Tv-Sat Prizi (Geçişli) 4DB/F Kon.	12	1.090,91
2270 157 02XX	Mek+Tuş Tv-Sat Prizi (Sonlu)	12	1.090,91
2270 166 01XX	Mek+Tuş Sat Prizi (Geçişli) 4DB/F Konnektör	12	909,09
2270 167 01XX	Mek+Tuş Sat Prizi (Sonlu)	12	909,09
2270 170 01XX	Mek+Tuş Tv Prizi (Geçişli) 11DB	12	318,18
2270 171 01XX	Mek+Tuş Tv Prizi (Sonlu)	12	318,18
2270 172 01XX	Mek+Tuş Tv Prizi F Dişi	12	272,73

Candelä

CANDELA SERİSİ, YUMUŞAK GEÇİŞLERİ VE DENGELİ FORMU İLE MEKÂNA DOĞAL BİR UYUM SAĞLAR. GÖZE ÇARPMADAN FARK YARATAN TASARIMIYLA, ŞIKLIĞI GÜNLÜK KULLANIMIN BİR PARÇASI HALİNE GETİRİR.



ŞIK ÇÖZÜMLER
DOĞRU TERCİH



ANAHTAR GRUBU - VİDALI TİP



2125 401 02XX
Anahtar



2125 402 02XX
Komütatör



2125 403 02XX
Vavien (iki yollu anahtar)



2125 404 02XX
Komütatör Vavien



2125 405 02XX
Çift Kutuplu Anahtar



2125 406 02XX
Jaluzi Anahtarı



2125 407 02XX
Çağırma



2125 407 02XXK
Kapı Otomatığı



2125 407 02XXZ
Zil Anahtarı



2125 408 02XX
Deviatör (Ara Vavien)



2125 409 02XX
Üçlü Anahtar



2125 411 02XX
Şofben Anahtarı



2125 415 02XX
Işıklı Anahtar (220V)



2125 416 02XX
Işıklı Vavien (220V)



2125 417 02XX
Işıklı Çağırma (220V)



2125 418 02XX
Işıklı Etiketli Anahtar (220V)



2125 419 02XX
Işıklı Etiketli Çağırma (220V)



2125 422 02XX
Işıklı Zil Etiketli Çağırma (12V)



2125 426 02XX
Işıklı Komitatör



2125 436 02XX
Tek Tuşlu Jaluzi Anahtarı

ANAHTAR GRUBU - KLİPSLİ TİP (KOLAY BAĞLANTI)



2125 401 01XX
Anahtar



2125 402 01XX
Komütatör



2125 403 01XX
Vavien (iki yollu anahtar)



2125 404 01XX
Komütatör Vavien



2125 405 01XX
Çift Kutuplu Anahtar



2125 406 01XX
Jaluzi Anahtarı



2125 407 01XX
Çağırma



2125 407 01XXK
Kapı Otomatığı



2125 407 01XXZ
Zil Anahtarı



2125 408 01XX
Deviatör (Ara Vavien)



2125 409 01XX
Üçlü Anahtar



2125 415 01XX
Işıklı Anahtar (220V)



2125 416 01XX
Işıklı Vavien (220V)



2125 417 01XX
Işıklı Çağırma (220V)



2125 418 01XX
Işıklı Etiketli Anahtar (220V)



2125 419 01XX
Işıklı Etiketli Çağırma (220V)



2125 422 01XX
Işıklı Zil Etiketli Çağırma (12V)



2125 426 01XX
Işıklı Komitatör



2125 436 01XX
Tek Tuşlu Jaluzi Anahtarı

DİMMER GRUBU



2125 440 02XX
RL Işıklı Dimmer 600W



2125 444 02XX
RL Işıklı Dimmer 1000W



2125 447 02XX
RC Dimmer 325W

ELEKTRONİK GRUBU



2125 450 01XX
Energy Saver Gecikmesiz Işıklı



2125 452 01XX
Energy Saver Gecikmeli Işıklı



2125 470 02XX
Müzik Yayın Anahtarı



2125 480 01XX
Hoparlör Prizi



2125 485 02XX
Uyarı Zili



2125 495 02XX
Hareket Sensörü

PRİZ GRUBU



2125 600 02XX

Topraklı Priz



2125 601 02XX

Topraksız Priz



2125 605 02XX

Topraklı Priz (Ç.K)



2125 606 02XX

Topraksız Priz (Ç.K)



2125 610 02XX

Kapaklı Topraklı Priz



2125 611 02XX

Kapaklı Topraklı Priz (Ç.K)



2125 615 02XX

Ups (Fransız) Prizi



2125 616 02XX

Ups (Fransız) Prizi (Ç.K)



2125 617 02XX

Ups Kapaklı (Fransız) Prizi



2125 618 02XX

Ups Kapaklı (Fransız) Prizi (Ç.K)



2125 448 01XX

Tekli USB Şarj Prizi



2125 469 01XX

İkili USB Şarj Prizi



2125 200 02XX

İkili Topraklı Priz Porselen



2125 201 02XX

İkili Topraksız Priz Porselen



2125 202 02XX

İkili Topraklı Priz



2125 203 02XX

İkili Topraksız Priz



2125 215 02XX

İkili UPS Priz

İLETİŞİM GRUBU



2125 125 01XX

Telefon Prizi 1XRj11 (Cat3)



2125 126 01XX

Telefon Prizi 2XRj11 (Cat3)



2125 128 01XX

Etiketli Telefon Data Prizi (Konnektörsüz)



2125 135 01XX

Data Prizi 1*Rj45 (Konnektörsüz)



2125 136 01XX

Data Prizi 1*Rj45 (Cat5e)



2125 137 01XX

Data Prizi 2*Rj45 (Konnektörsüz)



2220 138 01XX

Data Prizi 2*Rj45 (Cat5e)



2125 139 01XX

Telefon Data Prizi (Rj11 Cat3 + Cat5e)



2125 140 01XX

Data Prizi 1*Rj45 (Cat6)



2125 141 01XX

Data Prizi 2*Rj45 (Cat6)



2125 455 01XX

1*USB Priz



2125 456 01XX

2*USB Priz



2125 457 01XX

1*HDMI Priz



2125 458 01XX

2*HDMI Priz



2125 459 01XX

1*USB/1*HDMI Priz



2125 460 01XX

VGA Priz



2125 121 02XX

Kör Kapak

TV-SAT GRUBU



2125 156 02XX

Tv-Sat Prizi (Geçişli) 4DB/F Konnektörlü



2125 157 02XX

Tv-Sat Prizi (Sonlu)



2125 166 01XX

Sat Prizi (Geçişli) 4DB/F Konnektörlü



2125 167 01XX

Sat Prizi (Sonlu)



2125 170 01XX

Tv Prizi (Geçişli) 110B



2125 171 01XX

Tv Prizi (Sonlu)



2125 172 01XX

Tv Prizi F Dişi

NATURAL



01 -BEYAZ



02 -KREM

AHŞAP



56 -KIRAZ



57 -CEVİZ



58 -MEŞE

METALİK



80 -A.ALTIN



82 -INOX



83 -TİTANYUM



84 -SİYAH



85 -DORE



95 -FÜME



Candefä

Mekanizma + Tuş Ürün Listesi

Kod	Ürün Tanımı	Kutu Adedi	Koli Adedi	Beyaz/Krem Fiyat (₺)	Metalik Fiyat (₺)	Ahşap Fiyat (₺)
2100 401 02XX	Mek+Tuş Anahtar (Vidalı)	12	120	163,64	227,27	250,00
2100 402 02XX	Mek+Tuş Komütatör (Vidalı)	12	120	207,95	277,27	305,00
2100 403 02XX	Mek+Tuş Vavien (İki Yollu Anahtar)(Vidalı)	12	120	200,00	268,18	295,00
2100 404 02XX	Mek+Tuş Komütatör Vavien (Vidalı)	12	120	348,18	454,55	500,00
2100 405 02XX	Mek+Tuş Çift Kutuplu Anahtar (Vidalı)	12	120	231,82	295,45	325,00
2100 406 02XX	Mek+Tuş Jaluzi Anahtarı (Vidalı)	12	120	350,00	400,00	440,00
2100 407 02XX	Mek+Tuş Çağırma (Vidalı)	12	120	177,27	236,36	260,00
2100 407 02XXK	Mek+Tuş Kapı Otomatığı Anahtarı (Vidalı)	12	120	177,27	236,36	260,00
2100 407 02XXZ	Mek+Tuş Zil Anahtarı (Vidalı)	12	120	177,27	236,36	260,00
2100 408 02XX	Mek+Tuş Deviyatör(Ara Vavien)(Vidalı)	12	120	385,00	409,09	450,00
2100 409 02XX	Mek+Tuş Üçlü Anahtar (Vidalı)	12	120	340,00	431,82	475,00
2100 411 02XX	Mek+Tuş Şofben Anahtarı (Vidalı)	12	120	277,27	361,74	397,92
2100 415 02XX	Mek+Tuş Işıklı Anahtar (220V) (Vidalı)	12	120	275,00	363,64	400,00
2100 416 02XX	Mek+Tuş Işıklı Vavien (220V) (Vidalı)	12	120	340,00	418,18	460,00
2100 417 02XX	Mek+Tuş Işıklı Çağırma (220V)(Vidalı)	12	120	275,00	390,91	430,00
2100 418 02XX	Mek+Tuş Işıklı Etik. Anahtar (220V)(Vidalı)	12	120	306,00	340,91	375,00
2100 419 02XX	Mek+Tuş Işıklı Etik. Çağırma (220V)(Vidalı)	12	120	304,00	409,09	450,00
2100 422 02XX	Mek+Tuş Işıklı Zil Etik. Çağırma (12V)(Vidalı)	12	120	381,82	454,55	500,00
2100 426 02XX	Mek+Tuş Işıklı Komütatör (Vidalı)	12	120	363,64	386,36	425,00
2100 436 02XX	Mek+Tuş Jaluzi Anahtarı (Yaysız)(Vidalı)	12	120	340,00	404,55	445,00

Anahtar Grubu Klipsli Tip (Kolay Bağlantı)

2100 401 01XX	Mek+Tuş Anahtar (Klipsli)	12	120	163,64	227,27	250,00
2100 402 01XX	Mek+Tuş Komütatör (Klipsli)	12	120	207,95	277,27	305,00
2100 403 01XX	Mek+Tuş Vavien (İki Yollu Anahtar)(Klipsli)	12	120	200,00	268,18	295,00
2100 404 01XX	Mek+Tuş Komütatör Vavien (Klipsli)	12	120	348,18	454,55	500,00
2100 405 01XX	Mek+Tuş Çift Kutuplu Anahtar (Klipsli)	12	120	231,82	295,45	325,00
2100 406 01XX	Mek+Tuş Jaluzi Anahtarı (Klipsli)	12	120	350,00	400,00	440,00
2100 407 01XX	Mek+Tuş Çağırma (Klipsli)	12	120	177,27	236,36	260,00
2100 407 01XXK	Mek+Tuş Kapı Otomatığı Anahtarı (Klipsli)	12	120	177,27	236,36	260,00
2100 407 01XXZ	Mek+Tuş Zil Anahtarı (Klipsli)	12	120	177,27	236,36	260,00
2100 408 01XX	Mek+Tuş Deviyatör(Ara Vavien)(Klipsli)	12	120	385,00	409,09	450,00
2100 409 01XX	Mek+Tuş Üçlü Anahtar (Klipsli)	12	120	340,00	431,82	475,00
2100 415 01XX	Mek+Tuş Işıklı Anahtar (220V) (Klipsli)	12	120	275,00	363,64	400,00
2100 416 01XX	Mek+Tuş Işıklı Vavien (220V) (Klipsli)	12	120	340,00	418,18	460,00
2100 417 01XX	Mek+Tuş Işıklı Çağırma (220V)(Klipsli)	12	120	275,00	390,91	430,00
2100 418 01XX	Mek+Tuş Işıklı Etik. Anahtar (220V)(Klipsli)	12	120	306,00	340,91	375,00
2100 419 01XX	Mek+Tuş Işıklı Etik. Çağırma (220V)(Klipsli)	12	120	304,00	409,09	450,00
2100 422 01XX	Mek+Tuş Işıklı Zil Etik. Çağırma (12V)(Klipsli)	12	120	381,82	454,55	500,00
2100 426 01XX	Mek+Tuş Işıklı Komütatör (Vidalı)	12	120	363,64	386,36	425,00
2100 436 01XX	Mek+Tuş Jaluzi Anahtarı (Yaysız)(Klipsli)	12	120	340,00	404,55	445,00

Dimmer Grubu

2100 440 02XX	Mek+Tuş RL Işıklı Dimmer 600W	8	80	909,09	1.000,00	1.100,00
2100 444 02XX	Mek+Tuş RL Işıklı Dimmer 1000W	8	80	1.000,00	1.090,91	1.200,00
2100 447 02XX	Mek+Tuş RC Dimmer 325W	8	80	1.818,18	2.500,00	2.750,00

Priz Grubu

2100 600 02XX	Mek+Tuş Topraklı Priz	12	120	190,91	272,73	300,00
2100 601 02XX	Mek+Tuş Topraksız Priz	12	120	172,73	245,45	270,00
2100 605 02XX	Mek+Tuş Topraklı Priz (Ç.K.)	12	120	245,45	363,64	400,00
2100 606 02XX	Mek+Tuş Topraksız Priz (Ç.K.)	12	120	218,18	286,36	315,00
2100 610 02XX	Mek+Tuş Kapaklı Topraklı Priz	12	120	226,26	300,00	330,00
2100 611 02XX	Mek+Tuş Kapaklı Topraklı Priz (Ç.K.)	12	120	250,00	431,82	475,00
2100 615 02XX	Mek+Tuş Ups (Fransız) Prizi	12	120	248,33	359,09	395,00
2100 616 02XX	Mek+Tuş Ups (Fransız) Prizi (Ç.K.)	12	120	269,64	409,09	450,00
2100 617 02XX	Mek+Tuş Ups Kapaklı (Fransız) Priz	12	120	264,21	363,64	400,00
2100 618 02XX	Mek+Tuş Ups Kapaklı (Fr.) Priz (Ç.K.)	12	120	287,58	431,82	475,00
2100 200 02XX	Mek+Tuş İkili Topraklı Priz Porselen	5	50	431,82	545,45	600,00
2100 201 02XX	Mek+Tuş İkili Topraksız Priz Porselen	5	50	363,64	409,09	450,00
2100 202 02XX	Mek+Tuş İkili Topraklı Priz	5	50	345,45	409,09	450,00
2100 203 02XX	Mek+Tuş İkili Topraksız Priz	5	50	295,45	340,91	375,00
2100 215 01XX	Mek+Tuş İkili Ups Priz	5	50	340,91	431,82	475,00
2100 448 01XX	Mek+Tuş Tekli Usb Şarj Prizi	5	50	590,52	750,00	825,00
2100 469 01XX	Mek+Tuş İkili Usb + Type-C Şarj Prizi	5	50	750,00	863,64	950,00

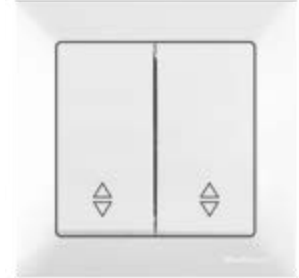

Candelā

Mekanizma + Tuş Ürün Listesi

Kod	Ürün Tanımı	Kutu Adedi	Koli Adedi	Beyaz/Krem Fiyat (₺)	Metalik Fiyat (₺)	Ahşap Fiyat (₺)
-----	-------------	------------	------------	----------------------	-------------------	-----------------

İletişim Grubu

2100 125 01XX	Mek+Tuş Telefon Prizi 1XRj11 (Cat3)	12	120	190,91	304,55	335,00
2100 126 01XX	Mek+Tuş Telefon Prizi 2XRj11 (Cat3)	12	120	318,18	440,91	485,00
2100 128 01XX	Mek+Tuş Etiketli Tlf Data Priz (Kon.süz)	12	120	136,36	197,73	217,50
2100 135 01XX	Mek+Tuş Data Prizi 1*Rj45 (Kon.süz)	12	120	136,36	177,95	195,75
2100 136 01XX	Mek+Tuş Data Prizi 1*Rj45 (Cat5e)	12	120	500,00	590,91	650,00
2100 137 01XX	Mek+Tuş Data Prizi 2*Rj45 (Kon.süz)	12	120	145,45	184,55	203,00
2100 138 01XX	Mek+Tuş Data Prizi 2*Rj45 (Cat5e)	12	120	727,27	818,18	900,00
2100 139 01XX	Mek+Tuş Tlf Data Priz (Rj11 Cat3 + Cat5e)	12	120	590,91	750,00	825,00
2100 140 01XX	Mek+Tuş Data Prizi 1*Rj45 (Cat6)	12	120	500,00	590,91	650,00
2100 141 01XX	Mek+Tuş Data Prizi 2*Rj45 (Cat6)	12	120	727,27	818,18	900,00
2100 455 01XX	Mek+Tuş 1*USB Priz	12	120	423,79	527,27	580,00
2100 456 01XX	Mek+Tuş 2*USB Priz	12	120	723,12	922,73	1.015,00
2100 457 01XX	Mek+Tuş 1*HDMI Priz	12	120	563,06	725,00	797,50
2100 458 01XX	Mek+Tuş 2*HDMI Priz	12	120	1.016,90	1.285,23	1.413,75
2100 459 01XX	Mek+Tuş 1*USB/1*HDMI Priz	12	120	1.152,03	1.515,91	1.667,50
2100 460 01XX	Mek+Tuş VGA Priz	12	120	1.208,93	1.515,91	1.667,50
2100 121 02XX	Mek+Tuş Kör Kapak	12	120	92,65	159,09	175,00



Elektronik Grubu

2100 450 01XX	Mek+Tuş Energy Saver G.siz Işıklı	8	80	1.000,00	1.212,25	1.333,48
2100 452 01XX	Mek+Tuş Energy Saver Gecikmeli Işıklı	8	80	1.000,00	1.276,05	1.403,66
2100 470 02XX	Mek+Tuş Müzik Yayın Anahtarı	8	80	1.422,09	1.515,01	1.666,51
2100 480 01XX	Mek+Tuş Hoparlör Prizi	8	80	278,57	403,91	444,30
2100 485 02XX	Mek+Tuş Uyanı Zili	8	80	2.135,09	2.329,15	2.562,06
2100 495 02XX	Mek+Tuş Hareket Sensörü	8	80	2.045,45	2.144,75	2.359,22



TV / SAT Grubu

2100 156 02XX	Mek+Tuş Tv-Sat Prizi (Geçişli) 4DB/F Kon.	12	120	863,64	1.090,91	1.200,00
2100 157 02XX	Mek+Tuş Tv-Sat Prizi (Sonlu)	12	120	863,64	1.090,91	1.200,00
2100 166 01XX	Mek+Tuş Sat Prizi (Geçişli) 4DB/F Kon.	12	120	795,45	909,09	1.000,00
2100 167 01XX	Mek+Tuş Sat Prizi (Sonlu)	12	120	795,45	909,09	1.000,00
2100 170 01XX	Mek+Tuş Tv Prizi (Geçişli) 11DB	12	120	272,73	318,18	350,00
2100 171 01XX	Mek+Tuş Tv Prizi (Sonlu)	12	120	272,73	318,18	350,00
2100 172 01XX	Mek+Tuş Tv Prizi F Dişi	12	120	204,55	272,73	300,00



Çerçeveler

2125 800 11XX	Tekli Çerçeve	20	400	21,59	86,36	95,00
2125 800 12XX	İkili Yatay Çerçeve	10	200	122,73	181,82	200,00
2125 800 13XX	Üçlü Yatay Çerçeve	10	50	159,09	250,00	275,00
2125 800 14XX	Dörtlü Yatay Çerçeve	10	50	195,45	318,18	350,00
2125 800 15XX	Beşli Yatay Çerçeve	10	50	245,45	386,36	425,00
2125 800 16XX	Altılı Yatay Çerçeve	10	50	295,45	454,55	500,00
2125 800 22XX	İkili Dikey Çerçeve	10	50	122,73	181,82	200,00
2125 800 23XX	Üçlü Dikey Çerçeve	10	50	159,09	250,00	275,00
2125 800 24XX	Dörtlü Dikey Çerçeve	10	50	195,45	318,18	350,00
2125 800 25XX	Beşli Dikey Çerçeve	10	50	245,45	386,36	425,00
2125 800 26XX	Altılı Dikey Çerçeve	10	50	295,45	454,55	500,00
2125 820 12XX	İkili Priz Çerçeve	12	60	86,36	136,36	150,00
2200 000 0001	IP44 Kapaklı Priz Conta	24	120	45,45	-	-



İngiliz Tip

2190 500 0201	İngiliz Tipi Anahtarlı Priz Beyaz	12	120	595,00	-	-
---------------	-----------------------------------	----	-----	--------	---	---

BELLA

BELLA SERİSİ, NEMLİ ALANLARA ÖZEL TASARIMIYLA
HEM GÜVENLİĞİ HEM DE MEKÂNSAL UYUMU BİR ARAYA
GETİRİR.
DETAYLARDA KALİTE, KULLANIMDA GÜVEN.



NEMLİ MEKANLARDA
GÜVENLİ KULLANIM



BELLA Serisi

Beyaz / Gri Ürün Listesi



Beyaz 01

Gri 03

Kod	Ürün Tanımı	Kutu Adedi	Koli Adedi	Fiyat (₺)
-----	-------------	------------	------------	-----------

Anahtar Grubu

2151 001 02XX	Anahtar	8	80	210,50
2151 002 02XX	Komütatör	8	80	246,08
2151 003 02XX	Vavien (İki Yollu Anahtar)	8	80	237,29
2151 005 02XX	Çift Kutuplu Anahtar	8	80	277,93
2151 006 02XX	Jaluzi Anahtar	8	80	325,44
2151 007 02XXX	Kapı Otomatığı Anahtar	8	80	222,65
2151 007 02XXZ	Zil Anahtar	8	80	222,65
2151 007 02XX	Çağırma Anahtar	8	80	222,65
2151 008 02XX	Deviatör (Ara Vavien)	8	80	341,98

Priz Grubu

2151 180 02XX	Kapaklı Topraklı Priz	8	80	245,41
2151 210 02XX	Kapaklı Topraklı İkili Priz	8	80	431,82
2151 220 02XX	Kapaklı Topraklı İkili Dikey Priz	8	80	431,82
2151 511 02XX	İkili Anahtar + Topraklı Priz	4	40	454,55
2151 521 02XX	İkili Komitatör + Topraklı Priz	4	40	500,00

TV / SAT Grubu

2151 166 02XX	Sat Prizi (Geçişli)	8	80	351,42
2151 167 02XX	Sat Prizi (Sonlu)	8	80	351,42
2151 170 02XX	TV Prizi (Geçişli)	8	80	343,39
2151 171 02XX	TV Prizi (Sonlu)	8	80	343,39

Buat Grubu

2151 000 01XX	6 Çıkış Buat	8	80	214,20
---------------	--------------	---	----	--------

BELLA Serisi

Ahşap Ürün Listesi



Armut 49

Maun 44

K. Ceviz 41

A. Kayın 40

Kod	Ürün Tanımı	Kutu Adedi	Koli Adedi	Fiyat (₺)
-----	-------------	------------	------------	-----------

Anahtar Grubu

2151 001 02XX	Anahtar Ahşap	8	80	263,13
2151 002 02XX	Komütatör Ahşap	8	80	307,60
2151 003 02XX	Vavien (İki Yollu Anahtar) Ahşap	8	80	296,61
2151 005 02XX	Çift Kutuplu Anahtar Ahşap	8	80	347,41
2151 006 02XX	Jaluzi Anahtar Ahşap	8	80	406,80
2151 007 02XX	Çağırma Anahtar Ahşap	8	80	278,32
2151 007 02XXX	Kapı Otomatığı Anahtar Ahşap	8	80	278,32
2151 007 02XXZ	Zil Anahtar Ahşap	8	80	278,32
2151 008 02XX	Deviatör (Ara Vavien)	8	80	427,47

Priz Grubu

2151 180 02XX	Kapaklı Topraklı Priz	8	80	306,76
2151 210 02XX	Kapaklı Topraklı İkili Priz	8	80	539,77
2151 220 02XX	Kapaklı Topraklı İkili Dikey Priz	8	80	539,77
2151 511 02XX	İkili Anahtar + Topraklı Priz	4	40	568,18
2151 521 02XX	İkili Komitatör + Topraklı Priz	4	40	625,00

TV / SAT Grubu

2151 166 02XX	Sat Prizi (Geçişli)	8	80	439,28
2151 167 02XX	Sat Prizi (Sonlu)	8	80	439,28
2151 170 02XX	TV Prizi (Geçişli)	8	80	429,24
2151 171 02XX	TV Prizi (Sonlu)	8	80	429,24

Buat Grubu

2151 000 01XX	6 Çıkış Buat	8	80	267,76
---------------	--------------	---	----	--------

NORA

SUYA VE NEME KARŐI KORUMALI NORA, ZORLU KOŐULLARDA DAĐI GÜVENLİ VE UZUN ÖMÜRLÜ BİR KULLANIM SUNAR. ŐIKLIK VE KORUMA BİR ARADA.





RİSKLERİ MINİMİZE EDEN

ŐIK VE KULLANIŐLI TASARIM



 @mutlusanelectric

 @mutlusanelk

 @mutlusanelektrik

 @mutlusanplastikelektrik

 @mutlusanplastikelektrik



NORA Serisi

Beyaz / Gri Ürün Listesi

Kod	Ürün Tanımı	Kutu Adedi	Koli Adedi	Fiyat (₺)
Anahtar Grubu				
2155 001 02XX	Anahtar	8	80	260,83
2155 002 02XX	Komütatör	8	80	326,05
2155 003 02XX	Vavien (İki Yollu Anahtar)	8	80	295,16
2155 004 02XX	Komütatör Vavien	8	80	383,91
2155 005 02XX	Çift Kutuplu Anahtar	8	80	334,66
2155 006 02XX	Jaluzi Anahtar	8	80	397,73
2155 007 02XX	Çağırma Anahtarı	8	80	293,85
2155 007 02XXZ	Zil Anahtarı	8	80	293,85
2155 008 02XX	Deviatör (Ara Vavien)	8	80	404,94
2155 037 02XX	Acil Çağırma (İpli)	8	80	450,20

Priz Grubu

2155 180 02XX	Kapaklı Topraklı Priz	8	80	282,56
2155 187 02XX	Kapaklı Topraklı UPS Priz	8	80	285,20
2155 188 02XX	Kapaklı Topraklı UPS Priz (Çocuk Korumalı)	8	80	306,67
2155 210 02XX	Kapaklı Topraklı İkili Priz	4	40	511,46
2155 217 02XX	Kapaklı Topraklı İkili UPS Priz	4	40	460,42
2155 220 02XX	Kapaklı Topraklı İkili Dikey Priz	4	40	510,34
2155 227 02XX	Kapaklı Topraklı İkili Dikey UPS Priz	4	40	524,70
2155 511 02XX	İkili Anahtar + Topraklı Priz	4	40	539,38
2155 521 02XX	İkili Komitatör + Topraklı Priz	4	40	584,48

TV / SAT Grubu

2155 166 02XX	Sat Prizi (Geçişli)	8	80	450,50
2155 167 02XX	Sat Prizi (Sonlu)	8	80	450,51
2155 170 02XX	TV Prizi (Geçişli)	8	80	417,15
2155 171 02XX	TV Prizi (Sonlu)	8	80	417,73

Buat Grubu

2155 000 01XX	4 Çıkış Buat	8	80	233,19
---------------	--------------	---	----	--------



Beyaz 01

Gri 03

BRON

KURU İÇ MEKÂNLARDA HIZLI MONTAJ VE GÜVENLİ
KULLANIM SAĞLAYARAK YAŞAM VE ÇALIŞMA
ALANLARINDA FONKSİYONEL BİR ÇÖZÜM SUNAR.



SIVA ÜSTÜ UYGULAMALARDA
SORUNSUZ İŞLEVSEL ÇÖZÜMLER



BRON Natural SIVA ÜSTÜ ANAHTAR PRİZ SERİSİ

Kod	Ürün Tanımı	Kutu Adedi	Koli Adedi	Fiyat (₺)
2160 301 02XX	Bron S/Ü Anahtar	12	120	204,55
2160 302 02XX	Bron S/Ü Komütatör	12	120	263,64
2160 303 02XX	Bron S/Ü Vavien	12	120	295,45
2160 307 02XX	Bron S/Ü Light (Çağırma)	12	120	209,09
2160 315 02XX	Bron S/Ü Işıklı Anahtar (220V)	12	120	259,09
2160 316 02XX	Bron S/Ü Işıklı Vavien (220V)	12	120	340,91
2160 317 02XX	Bron S/Ü Işıklı Light (Çağırma) (220V)	12	120	276,09
2160 326 02XX	Bron S/Ü Işıklı Komütatör	12	120	316,75
2160 100 02XX	Bron S/Ü Topraklı Priz	12	120	235,95
2160 101 02XX	Bron S/Ü Topraksız Priz	12	120	204,55
2160 103 02XX	Bron S/Ü Topraklı Priz Porselen	12	120	315,42
2160 104 02XX	Bron S/Ü Topraksız Priz Porselen	12	120	273,14
2160 110 02XX	Bron S/Ü Kapaklı Topraklı Priz	10	100	272,73
2160 113 02XX	Bron S/Ü Kapaklı Topraklı Priz Porselen	10	100	338,21
2160 115 02XX	Bron S/Ü Ups (Fransız) Priz	12	120	257,00
2160 125 02XX	Bron S/Ü Telefon Prizi 1*Rj11 Cat3	12	120	181,82
2160 136 02XX	Bron S/Ü Data Prizi 1*Rj45 (Cat5)	12	120	204,55
2160 140 02XX	Bron S/Ü Data Prizi 1*Rj45 (Cat6)	12	120	204,55
2160 166 02XX	Bron S/Ü Sat Prizi (Geçişli) 4Db/F Konnektör	12	120	363,64
2160 167 02XX	Bron S/Ü Sat Prizi (Sonlu)	12	120	363,64
2160 170 02XX	Bron S/Ü Tv Prizi (Geçişli)	12	120	363,64
2160 171 02XX	Bron S/Ü Tv Prizi (Sonlu)	12	120	363,64
2160 200 02XX	Bron S/Ü İkili Topraklı Priz Porselen	6	60	386,52
2160 201 02XX	Bron S/Ü İkili Topraksız Priz Porselen	6	60	345,24
2160 202 02XX	Bron S/Ü İkili Topraklı Priz	6	60	337,85
2160 203 02XX	Bron S/Ü İkili Topraksız Priz	6	60	294,90
2160 215 02XX	Bron S/Ü İkili Ups (Fransız) Priz	6	60	334,50



Beyaz
 01

Krem
 02

Meşe / Ceviz Ürün Listesi

BRON Ahşap SIVA ÜSTÜ ANAHTAR PRİZ SERİSİ

Kod	Ürün Tanımı	Kutu Adedi	Koli Adedi	Fiyat (₺)
2160 301 02XX	Bron S/Ü Anahtar	12	120	272,73
2160 302 02XX	Bron S/Ü Komütatör	12	120	340,91
2160 303 02XX	Bron S/Ü Vavien	12	120	363,64
2160 307 02XX	Bron S/Ü Light (Çağırma)	12	120	272,73
2160 315 02XX	Bron S/Ü Işıklı Anahtar (220V)	12	120	327,27
2160 316 02XX	Bron S/Ü Işıklı Vavien (220V)	12	120	409,09
2160 317 02XX	Bron S/Ü Işıklı Light (Çağırma) (220V)	12	120	340,91
2160 326 02XX	Bron S/Ü Işıklı Komütatör	12	120	386,36
2160 100 02XX	Bron S/Ü Topraklı Priz	12	120	295,45
2160 101 02XX	Bron S/Ü Topraksız Priz	12	120	272,73
2160 103 02XX	Bron S/Ü Topraklı Priz Porselen	12	120	363,64
2160 104 02XX	Bron S/Ü Topraksız Priz Porselen	12	120	318,18
2160 110 02XX	Bron S/Ü Kapaklı Topraklı Priz	10	100	363,64
2160 113 02XX	Bron S/Ü Kapaklı Topraklı Priz Porselen	10	100	431,82
2160 115 02XX	Bron S/Ü Ups (Fransız) Priz	12	120	318,18
2160 125 02XX	Bron S/Ü Telefon Prizi 1*Rj11 Cat3	12	120	250,00
2160 136 02XX	Bron S/Ü Data Prizi 1*Rj45 (Cat5)	12	120	295,45
2160 140 02XX	Bron S/Ü Data Prizi 1*Rj45 (Cat6)	12	120	295,45
2160 166 02XX	Bron S/Ü Sat Prizi (Geçişli) 4Db/F Konnektör	12	120	409,09
2160 167 02XX	Bron S/Ü Sat Prizi (Sonlu)	12	120	409,09
2160 170 02XX	Bron S/Ü Tv Prizi (Geçişli)	12	120	409,09
2160 171 02XX	Bron S/Ü Tv Prizi (Sonlu)	12	120	409,09
2160 200 02XX	Bron S/Ü İkili Topraklı Priz Porselen	6	60	431,82
2160 201 02XX	Bron S/Ü İkili Topraksız Priz Porselen	6	60	386,36
2160 202 02XX	Bron S/Ü İkili Topraklı Priz	6	60	363,64
2160 203 02XX	Bron S/Ü İkili Topraksız Priz	6	60	340,91
2160 215 02XX	Bron S/Ü İkili Ups (Fransız) Priz	6	60	363,64



Meşe
 58

Ceviz
 57

Fiş Prizler

Ri-tech

Olimpia

Liva

Plus

GÜVENLİ ENERJİ ÇÖZÜMLERİYLE HAYATI KOLAYLAŞTIRAN GRUP PRİZ, ŞARJ ADAPTÖRÜ VE ŞOK KORUMALI ÜRÜNLER; MODERN TASARIM VE YÜKSEK PERFORMANSI BİR ARADA SUNAR.



TAŞINABİLİR ENERJİ

KULLANIŞLI SEÇENEKLER



@mutlusanelectric

@mutlusanelk

@mutlusanelektrik

@mutusanplastikelektrik

@mutusanplastikelektrik



Ri-tech Grup Prizler

Kod	Ürün Tanımı	Kutu Adedi	Fiyat (₺)
001 175 210001 00 00	İkili Topraklı Grup Priz (Çocuk Korumalı)(Klemensli)	25	318,18
001 175 210002 01 00	İkili Topraklı Grup Priz (Çocuk Korumalı)(1 m)	12	636,36
001 175 210002 02 00	İkili Topraklı Grup Priz (Çocuk Korumalı)(2 m)	12	772,73
001 175 210002 03 00	İkili Topraklı Grup Priz (Çocuk Korumalı)(3 m)	12	931,82
001 175 210002 05 00	İkili Topraklı Grup Priz (Çocuk Korumalı)(5 m)	12	1.204,55
001 175 220001 00 00	İkili Anahtarlı Topraklı Grup Priz (Çocuk Korumalı)(Klemensli)	25	590,91
001 175 220002 01 00	İkili Anahtarlı Topraklı Grup Priz (Çocuk Korumalı)(1 m)	12	1.000,00
001 175 220002 02 00	İkili Anahtarlı Topraklı Grup Priz (Çocuk Korumalı)(2 m)	12	1.136,36
001 175 220002 03 00	İkili Anahtarlı Topraklı Grup Priz (Çocuk Korumalı)(3 m)	12	1.340,91
001 175 220002 05 00	İkili Anahtarlı Topraklı Grup Priz (Çocuk Korumalı)(5 m)	12	1.636,36
001 175 310001 00 00	Üçlü Topraklı Grup Priz (Çocuk Korumalı)(Klemensli)	25	363,64
001 175 310002 01 00	Üçlü Topraklı Grup Priz (Çocuk Korumalı)(1 m)	12	704,55
001 175 310002 02 00	Üçlü Topraklı Grup Priz (Çocuk Korumalı)(2 m)	12	886,36
001 175 310002 03 00	Üçlü Topraklı Grup Priz (Çocuk Korumalı)(3 m)	12	1.045,45
001 175 310002 05 00	Üçlü Topraklı Grup Priz (Çocuk Korumalı)(5 m)	12	1.363,64
001 175 320001 00 00	Üçlü Anahtarlı Topraklı Grup Priz (Çocuk Korumalı)(Klemensli)	25	659,09
001 175 320002 01 00	Üçlü Anahtarlı Topraklı Grup Priz (Çocuk Korumalı)(1 m)	12	1.090,91
001 175 320002 02 00	Üçlü Anahtarlı Topraklı Grup Priz (Çocuk Korumalı)(2 m)	12	1.204,55
001 175 320002 03 00	Üçlü Anahtarlı Topraklı Grup Priz (Çocuk Korumalı)(3 m)	12	1.431,82
001 175 320002 05 00	Üçlü Anahtarlı Topraklı Grup Priz (Çocuk Korumalı)(5 m)	12	1.763,64
001 175 350101 00 00	Üçlü Usb + Type-C Anaht. Topraklı Grup Priz (Çocuk Korumalı)(Klemensli)	25	1.718,18
001 175 350102 02 00	Üçlü Usb + Type-C Anahtarlı Topraklı Grup Priz (Çocuk Korumalı)(2 m)	12	2.243,18
001 175 350102 03 00	Üçlü Usb + Type-C Anahtarlı Topraklı Grup Priz (Çocuk Korumalı)(3 m)	12	2.481,82
001 175 350102 05 00	Üçlü Usb + Type-C Anahtarlı Topraklı Grup Priz (Çocuk Korumalı)(5 m)	12	2.863,64
001 175 410001 00 00	Dörtlü Topraklı Grup Priz (Çocuk Korumalı)(Klemensli)	25	454,55
001 175 410002 01 00	Dörtlü Topraklı Grup Priz (Çocuk Korumalı)(1 m)	12	863,64
001 175 410002 02 00	Dörtlü Topraklı Grup Priz (Çocuk Korumalı)(2 m)	12	1.000,00
001 175 410002 03 00	Dörtlü Topraklı Grup Priz (Çocuk Korumalı)(3 m)	12	1.181,82
001 175 410002 05 00	Dörtlü Topraklı Grup Priz (Çocuk Korumalı)(5 m)	12	1.477,27
001 175 420001 00 00	Dörtlü Anahtarlı Topraklı Grup Priz (Çocuk Korumalı)(Klemensli)	25	772,73
001 175 420002 01 00	Dörtlü Anahtarlı Topraklı Grup Priz (Çocuk Korumalı)(1 m)	12	1.295,45
001 175 420002 02 00	Dörtlü Anahtarlı Topraklı Grup Priz (Çocuk Korumalı)(2 m)	12	1.409,09
001 175 420002 03 00	Dörtlü Anahtarlı Topraklı Grup Priz (Çocuk Korumalı)(3 m)	12	1.636,36
001 175 420002 05 00	Dörtlü Anahtarlı Topraklı Grup Priz (Çocuk Korumalı)(5 m)	12	1.909,09
001 175 610001 00 00	Altılı Topraklı Grup Priz (Çocuk Korumalı)(Klemensli)	25	727,27
001 175 610002 01 00	Altılı Topraklı Grup Priz (Çocuk Korumalı)(1 m)	12	1.204,55
001 175 610002 02 00	Altılı Topraklı Grup Priz (Çocuk Korumalı)(2 m)	12	1.409,09
001 175 610002 03 00	Altılı Topraklı Grup Priz (Çocuk Korumalı)(3 m)	12	1.636,36
001 175 610002 05 00	Altılı Topraklı Grup Priz (Çocuk Korumalı)(5 m)	12	2.000,00
001 175 620001 00 00	Altılı Anahtarlı Topraklı Grup Priz (Çocuk Korumalı)(Klemensli)	25	954,55
001 175 620002 01 00	Altılı Anahtarlı Topraklı Grup Priz (Çocuk Korumalı)(1 m)	12	1.545,45
001 175 620002 02 00	Altılı Anahtarlı Topraklı Grup Priz (Çocuk Korumalı)(2 m)	12	1.704,55
001 175 620002 03 00	Altılı Anahtarlı Topraklı Grup Priz (Çocuk Korumalı)(3 m)	12	1.909,09
001 175 620002 05 00	Altılı Anahtarlı Topraklı Grup Priz (Çocuk Korumalı)(5 m)	12	2.272,73
001 175 650101 00 00	Altılı Usb + Type-C Anaht. Topraklı Grup Priz (Çocuk Korumalı)(Klemensli)	25	2.000,00
001 175 650102 02 00	Altılı Usb + Type-C Anahtarlı Topraklı Grup Priz (Çocuk Korumalı)(2 m)	12	2.727,27
001 175 650102 03 00	Altılı Usb + Type-C Anahtarlı Topraklı Grup Priz (Çocuk Korumalı)(3 m)	12	2.954,55
001 175 650102 05 00	Altılı Usb + Type-C Anahtarlı Topraklı Grup Priz (Çocuk Korumalı)(5 m)	12	3.340,91

Ri-tech Grup Prizler

Kod	Ürün Tanımı	Kutu Adedi	Fiyat (₺)
001 175 330001 00 00	Üçlü Ups Grup Priz (Çocuk Koruma)(Klemensli)	25	477,27
001 175 330002 02 00	Üçlü Ups Grup Priz (Çocuk Koruma)(2 m)	12	1.113,64
001 175 330002 03 00	Üçlü Ups Grup Priz (Çocuk Koruma)(3 m)	12	1.304,31
001 175 330002 05 00	Üçlü Ups Grup Priz (Çocuk Koruma)(5 m)	12	1.716,51
001 175 340001 00 00	Üçlü Anahtarlı Ups Grup Priz (Çocuk Koruma)(Klemensli)	25	750,00
001 175 340002 02 00	Üçlü Anahtarlı Ups Grup Priz (Çocuk Koruma)(2 m)	12	1.340,91
001 175 340002 03 00	Üçlü Anahtarlı Ups Grup Priz (Çocuk Koruma)(3 m)	12	1.505,89
001 175 340002 05 00	Üçlü Anahtarlı Ups Grup Priz (Çocuk Koruma)(5 m)	12	1.787,07
001 175 430001 00 00	Dörtlü Ups Grup Priz (Çocuk Koruma)(Klemensli)	25	727,27
001 175 430002 02 00	Dörtlü Ups Grup Priz (Çocuk Koruma)(2 m)	12	1.454,55
001 175 430002 03 00	Dörtlü Ups Grup Priz (Çocuk Koruma)(3 m)	12	1.500,00
001 175 430002 05 00	Dörtlü Ups Grup Priz (Çocuk Koruma)(5 m)	12	1.818,18
001 175 440001 00 00	Dörtlü Anahtarlı Ups Grup Priz (Çocuk Koruma)(Klemensli)	25	1.136,36
001 175 440002 02 00	Dörtlü Anahtarlı Ups Grup Priz (Çocuk Koruma)(2 m)	12	1.727,27
001 175 440002 03 00	Dörtlü Anahtarlı Ups Grup Priz (Çocuk Koruma)(3 m)	12	2.000,00
001 175 440002 05 00	Dörtlü Anahtarlı Ups Grup Priz (Çocuk Koruma)(5 m)	12	2.272,73
001 175 630001 00 00	Altılı Ups Grup Priz (Çocuk Koruma)(Klemensli)	25	798,46
001 175 630002 02 00	Altılı Ups Grup Priz (Çocuk Koruma)(2 m)	12	1.567,77
001 175 630002 03 00	Altılı Ups Grup Priz (Çocuk Koruma)(3 m)	12	1.852,32
001 175 630002 05 00	Altılı Ups Grup Priz (Çocuk Koruma)(5 m)	12	2.431,80
001 175 640001 00 00	Altılı Anahtarlı Ups Grup Priz (Çocuk Koruma)(Klemensli)	25	1.271,29
001 175 640002 02 00	Altılı Anahtarlı Ups Grup Priz (Çocuk Koruma)(2 m)	12	2.046,97
001 175 640002 03 00	Altılı Anahtarlı Ups Grup Priz (Çocuk Koruma)(3 m)	12	2.331,86
001 175 640002 05 00	Altılı Anahtarlı Ups Grup Priz (Çocuk Koruma)(5 m)	12	2.911,92



ALTILI ŞOK KORUMALI
USB ANAHTAR TOPRAKLI
GRUP PRİZ



ANAHTAR PRİZ GRUBU

Ri-tech Akım (Şok) Korumalı Grup Priz

Kod	Ürün Tanımı	Kutu Adedi	Fiyat (₺)
001 175 660002 15 00	Altılı Şok Koruma USB Anahtarlı Topraklı Grup Priz (Ç.K.) (3X1.5 1.5 m)	12	2.636,36
001 175 670002 15 00	Altılı Şok Koruma Anahtarlı Topraklı Grup Priz (Ç.K.) (3X1.5 1.5 m)	12	2.159,09
001 175 370002 15 00	Üçlü Şok Koruma Anahtarlı Topraklı Grup Priz (Ç.K.) (3X1.5 1.5 m)	12	1.954,55
001 175 370002 03 00	Üçlü Şok Koruma Anahtarlı Topraklı Grup Priz (Ç.K.) (3X1.5 3 m)	12	2.250,00
001 888 100004 00 00	Tekli Şok Korumalı Priz	12	818,18



TEKLI ŞOK KORUMALI PRİZ



USB + TYPE-C
ŞARJ ADAPTÖR

Ri-tech USB Şarj

Kod	Ürün Tanımı	Kutu Adedi	Fiyat (₺)
001 888 100002 00 00	2'Li USB ŞARJ ADAPTÖR 2,4A	20	500,00
001 888 100003 00 00	USB + TYPE-C ŞARJ ADAPTÖR 2,4A	20	568,18



* Çoklu çerçeve ile kullanılamaz.

Kod	Ürün Tanımı	Kutu Adedi	Koli Adedi	Beyaz/Krem Fiyat (₺)	Metalik Fiyat (₺)	Ahşap Fiyat (₺)
2220 629 02XX	RİTA USB +TYPE-C TOPRAKLI PRİZ (ÇERÇEVE DAHİL)	8	-	909,09	1.363,64	1.500,00

Olimpia Grup Prizler

Kod	Ürün Tanımı	Kutu Adedi	Fiyat (₺)
001 171 290001 00 00	İkili Topraksız Grup Priz (Klemensli) Olimpia	25	238,64
001 171 290002 02 00	İkili Topraksız Grup Priz (2 m) Olimpia	12	579,55
001 171 290002 03 00	İkili Topraksız Grup Priz (3 m) Olimpia	12	698,86
001 171 290002 05 00	İkili Topraksız Grup Priz (5 m) Olimpia	12	903,41
001 171 210001 00 00	İkili Topraklı Grup Priz (Klemensli) Olimpia	25	318,18
001 171 210002 02 00	İkili Topraklı Grup Priz (2 m) Olimpia	12	772,73
001 171 210002 03 00	İkili Topraklı Grup Priz (3 m) Olimpia	12	931,82
001 171 210002 05 00	İkili Topraklı Grup Priz (5 m) Olimpia	12	1.204,55
001 171 390001 00 00	Üçlü Topraksız Grup Priz (Klemensli) Olimpia	25	295,45
001 171 390002 02 00	Üçlü Topraksız Grup Priz (2 m) Olimpia	12	664,77
001 171 390002 03 00	Üçlü Topraksız Grup Priz (3 m) Olimpia	12	784,09
001 171 390002 05 00	Üçlü Topraksız Grup Priz (5 m) Olimpia	12	1.022,73
001 171 310001 00 00	Üçlü Grup Priz Topraklı (Klemensli) Olimpia	25	363,64
001 171 310002 02 00	Üçlü Topraklı Grup Priz (2 m) Olimpia	12	886,36
001 171 310002 03 00	Üçlü Topraklı Grup Priz (3 m) Olimpia	12	1.045,45
001 171 310002 05 00	Üçlü Topraklı Grup Priz (5 m) Olimpia	12	1.363,64
001 171 320001 00 00	Üçlü Topraklı Grup Priz (Klemensli Anahtarlı) Olimpia	25	659,09
001 171 320002 02 00	Üçlü Topraklı Grup Priz (Anahtarlı 2 m) Olimpia	12	1.204,55
001 171 320002 03 00	Üçlü Topraklı Grup Priz (Anahtarlı 3 m) Olimpia	12	1.431,82
001 171 320002 05 00	Üçlü Topraklı Grup Priz (Anahtarlı 5 m) Olimpia	12	1.763,64
001 171 340001 00 00	Üçlü Ups Grup Priz (Klemensli) Olimpia	25	477,27
001 171 330001 02 00	Üçlü Ups Grup Priz (2 m) Olimpia	12	1.113,64
001 171 330001 03 00	Üçlü Ups Grup Priz (3 m) Olimpia	12	1.304,31
001 171 330001 05 00	Üçlü Ups Grup Priz (5 m) Olimpia	12	1.716,51
001 171 410001 00 00	Dörtlü Topraklı Grup Priz (Klemensli) Olimpia	25	454,55
001 171 410001 02 00	Dörtlü Topraklı Grup Priz (2 m) Olimpia	12	1.000,00
001 171 410001 03 00	Dörtlü Topraklı Grup Priz (3 m) Olimpia	12	1.181,82
001 171 410001 05 00	Dörtlü Topraklı Grup Priz (5 m) Olimpia	12	1.477,27
001 171 410002 00 00	Dörtlü Topraklı Grup Priz (Klemensli-Anahtarlı) Olimpia	25	772,73
001 171 410002 02 00	Dörtlü Topraklı Grup Priz (Anahtarlı 2 m) Olimpia	12	1.409,09
001 171 410002 03 00	Dörtlü Topraklı Grup Priz (Anahtarlı 3 m) Olimpia	12	1.636,36
001 171 410002 05 00	Dörtlü Topraklı Grup Priz (Anahtarlı 5 m) Olimpia	12	1.909,09
001 171 610001 00 00	Altılı Grup Priz Topraklı (Klemensli) Olimpia	25	727,27
001 171 610001 02 00	Altılı Topraklı Grup Priz (2 m) Olimpia	12	1.409,09
001 171 610001 03 00	Altılı Topraklı Grup Priz (3 m) Olimpia	12	1.636,36
001 171 610001 05 00	Altılı Topraklı Grup Priz (5 m) Olimpia	12	2.000,00
001 171 610002 00 00	Altılı Topraklı Grup Priz (Klemensli-Anahtarlı) Olimpia	25	954,55
001 171 610002 02 00	Altılı Topraklı Grup Priz (Anahtarlı 2 m) Olimpia	12	1.704,55
001 171 610002 03 00	Altılı Topraklı Grup Priz (Anahtarlı 3 m) Olimpia	12	1.909,09
001 171 610002 05 00	Altılı Topraklı Grup Priz (Anahtarlı 5 m) Olimpia	12	2.272,73
001 170 110001 00 00	PLUS 10'lu Topraklı Grup Priz (Klemensli)	20	1.400,71

YENİ

LİVA ile ENERJİYİ YÖNET!



ANAHTAR PRİZ GRUBU

LİVA Fiş Prizler



CE

Ürün Kodu	001 174 250101 00 17
Ürün Adı	LİVA Topraklı İki USB+TYPE-C Fiş Priz (Çocuk Korumalı) Yonca Tip (S/Ü)
Kutu /Koli Adedi	12 / 48
Fiyat (₺)	1.045,45



CE

Ürün Kodu	001 174 220001 00 17
Ürün Adı	LİVA Topraklı İki Anahtarlı Fiş Priz (Çocuk Korumalı) Yonca Tip (S/Ü)
Kutu /Koli Adedi	12 / 48
Fiyat (₺)	568,18



CE

Ürün Kodu	001 174 210001 00 17
Ürün Adı	LİVA Topraklı İki Fiş Priz (Çocuk Korumalı) Düz Tip (S/Ü)
Kutu /Koli Adedi	12 / 48
Fiyat (₺)	386,36



CE

Ürün Kodu	001 174 310001 00 17
Ürün Adı	LİVA Topraklı Üçlü Fiş Priz (Çocuk Korumalı) Yonca Tip (S/Ü)
Kutu /Koli Adedi	12 / 48
Fiyat (₺)	545,45

Olimpiā Fiş Priz Aksesuarları



CE

Ürün Kodu	001 170 012001 00 00
Ürün Adı	Olimpia Topraklı Erkek Fiş (Kuyruklu)
Kutu Adedi	50
Fiyat (₺)	120,45



CE

Ürün Kodu	001 170 010001 00 00
Ürün Adı	Olimpia Erkek Fiş
Kutu Adedi	50
Fiyat (₺)	84,09



CE

Ürün Kodu	001 170 013001 00 00
Ürün Adı	Olimpia Topraklı Erkek Fiş Üps (Kuyruklu)
Kutu Adedi	50
Fiyat (₺)	122,73



CE

Ürün Kodu	001 170 020001 00 00
Ürün Adı	Olimpia Dişi Fiş
Kutu Adedi	50
Fiyat (₺)	67,05



CE

Ürün Kodu	001 170 011001 00 00
Ürün Adı	Olimpia Topraklı Erkek Fiş
Kutu Adedi	50
Fiyat (₺)	120,45



CE

Ürün Kodu	001 170 021001 00 00
Ürün Adı	Olimpia Topraklı Dişi Fiş
Kutu Adedi	25
Fiyat (₺)	127,27



CE

Ürün Kodu	001 170 014001 00 00
Ürün Adı	Olimpia Topraklı Erkek Fiş Üps
Kutu Adedi	50
Fiyat (₺)	131,82



CE

Ürün Kodu	001 888 000001 00 00
Ürün Adı	Prizmatik Priz Koruma Kapağı
Kutu Adedi	100
Fiyat (₺)	39,19



CE

Ürün Kodu	001 170 033006 00 00
Ürün Adı	Olimpia ikili Topraklı Fiş-Priz (Düz Tip Beyaz)
Kutu Adedi	30
Fiyat (₺)	256,53



CE

Ürün Kodu	001 170 033007 00 00
Ürün Adı	Olimpia ikili Topraklı Fiş-Priz (Düz Tip Beyaz Anahtarlı)
Kutu Adedi	28
Fiyat (₺)	438,49



CE

Ürün Kodu	001 170 033006 00 11
Ürün Adı	Olimpia ikili Topraklı Fiş-Priz (Düz Tip Siyah)
Kutu Adedi	30
Fiyat (₺)	256,53



CE

Ürün Kodu	001 170 033007 00 11
Ürün Adı	Olimpia ikili Topraklı Fiş-Priz (Düz Tip Siyah Anahtarlı)
Kutu Adedi	28
Fiyat (₺)	438,49

Plus Fiş Priz Aksesuarları



CE

Ürün Kodu	001 170 051001 00 00
Ürün Adı	Plus Topraklı Erkek Fiş
Kutu Adedi	100
Fiyat (₺)	122,73



CE

Ürün Kodu	001 170 061001 00 00
Ürün Adı	Plus Topraklı Dişi Fiş
Kutu Adedi	50
Fiyat (₺)	131,82



Ürün Kodu	001 170 050001 00 00
Ürün Adı	Plus Erkek Fiş
Kutu Adedi	100
Fiyat (₺)	86,36



CE

Ürün Kodu	001 170 060001 00 00
Ürün Adı	Plus Dişi Fiş
Kutu Adedi	100
Fiyat (₺)	69,32



CE

Ürün Kodu	001 170 011002 00 00
Ürün Adı	Plus Kulplu Topraklı Erkek Fiş
Kutu Adedi	100
Fiyat (₺)	118,16



Ürün Kodu	001 170 030002 00 00
Ürün Adı	Plus Adaptör Fiş, Priz (İngiliz Tip)
Kutu Adedi	100
Fiyat (₺)	115,88



CE

Ürün Kodu	001 170 033001 00 00
Ürün Adı	Plus Topraklı Üçlü Fiş-Priz (Yonca Tip) (S/A)
Kutu Adedi	20
Fiyat (₺)	412,24



CE

Ürün Kodu	001 170 033002 00 00
Ürün Adı	Plus Topraklı Üçlü Fiş-Priz (Yonca Tip) (S/Ü)
Kutu Adedi	40
Fiyat (₺)	402,76



CE

Ürün Kodu	001 170 033003 00 00
Ürün Adı	Plus İkili Topraklı Fiş-Priz (Düz Tip)
Kutu Adedi	50
Fiyat (₺)	406,58



CE

Ürün Kodu	001 170 033005 00 00
Ürün Adı	Plus Üçlü Topraklı Fiş-Priz (Düz Tip)
Kutu Adedi	40
Fiyat (₺)	476,14



CE

Ürün Kodu	001 170 030001 00 00
Ürün Adı	Plus Arapuar Anahtar
Kutu Adedi	50/600
Fiyat (₺)	74,57



CE

Ürün Kodu	001 170 033004 00 00
Ürün Adı	Plus Üçlü Topraklı Fiş-Priz (Düz Tip - Anahtarlı)
Kutu Adedi	30
Fiyat (₺)	640,50

Plus Fiş Priz Aksesuarları



CE

Ürün Kodu	001 170 011002 00 11
Ürün Adı	Plus Kulplu Topraklı Erkek Fiş Siyah
Kutu Adedi	100
Fiyat (₺)	118,16



CE

Ürün Kodu	001 170 050001 00 11
Ürün Adı	Plus Erkek Fiş Siyah
Kutu Adedi	100
Fiyat (₺)	80,06



CE

Ürün Kodu	001 170 051001 00 11
Ürün Adı	Plus Topraklı Erkek Fiş Siyah
Kutu Adedi	100
Fiyat (₺)	117,17



CE

Ürün Kodu	001 170 060001 00 11
Ürün Adı	Plus Dişi Fiş Siyah
Kutu Adedi	100
Fiyat (₺)	60,86



CE

Ürün Kodu	001 170 061001 00 11
Ürün Adı	Plus Topraklı Dişi Fiş Siyah
Kutu Adedi	50
Fiyat (₺)	131,46



CE

Ürün Kodu	001 170 030001 00 11
Ürün Adı	Plus Arapuar Anahtar Siyah
Kutu Adedi	50/600
Fiyat (₺)	74,57



CE

Ürün Kodu	001 170 033002 00 11
Ürün Adı	Plus Topraklı Üçlü Fiş-Priz (Yonca Tip) (S/Ü) Siyah
Kutu Adedi	40
Fiyat (₺)	402,76



CE

Ürün Kodu	001 170 033003 00 11
Ürün Adı	Plus İkili Topraklı Fiş-Priz Düz Tip Siyah
Kutu Adedi	50
Fiyat (₺)	406,58



CE

Ürün Kodu	001 170 033005 00 11
Ürün Adı	Plus Üçlü Topraklı Fiş-Priz (Düz Tip) Siyah
Kutu Adedi	40
Fiyat (₺)	476,14



CE

Ürün Kodu	001 170 033004 00 11
Ürün Adı	Plus Üçlü Topraklı Anahtarlı Fiş-Priz (Düz Tip) Siyah
Kutu Adedi	30
Fiyat (₺)	640,50



CE

Ürün Kodu	001 170 030002 00 11
Ürün Adı	Plus Adaptör Fiş, Priz (İngiliz Tip) Siyah
Kutu Adedi	100
Fiyat (₺)	115,88

KABLO KANALLARI PLASTİK, TESİSAT ve AYDINLATMA GRUBU

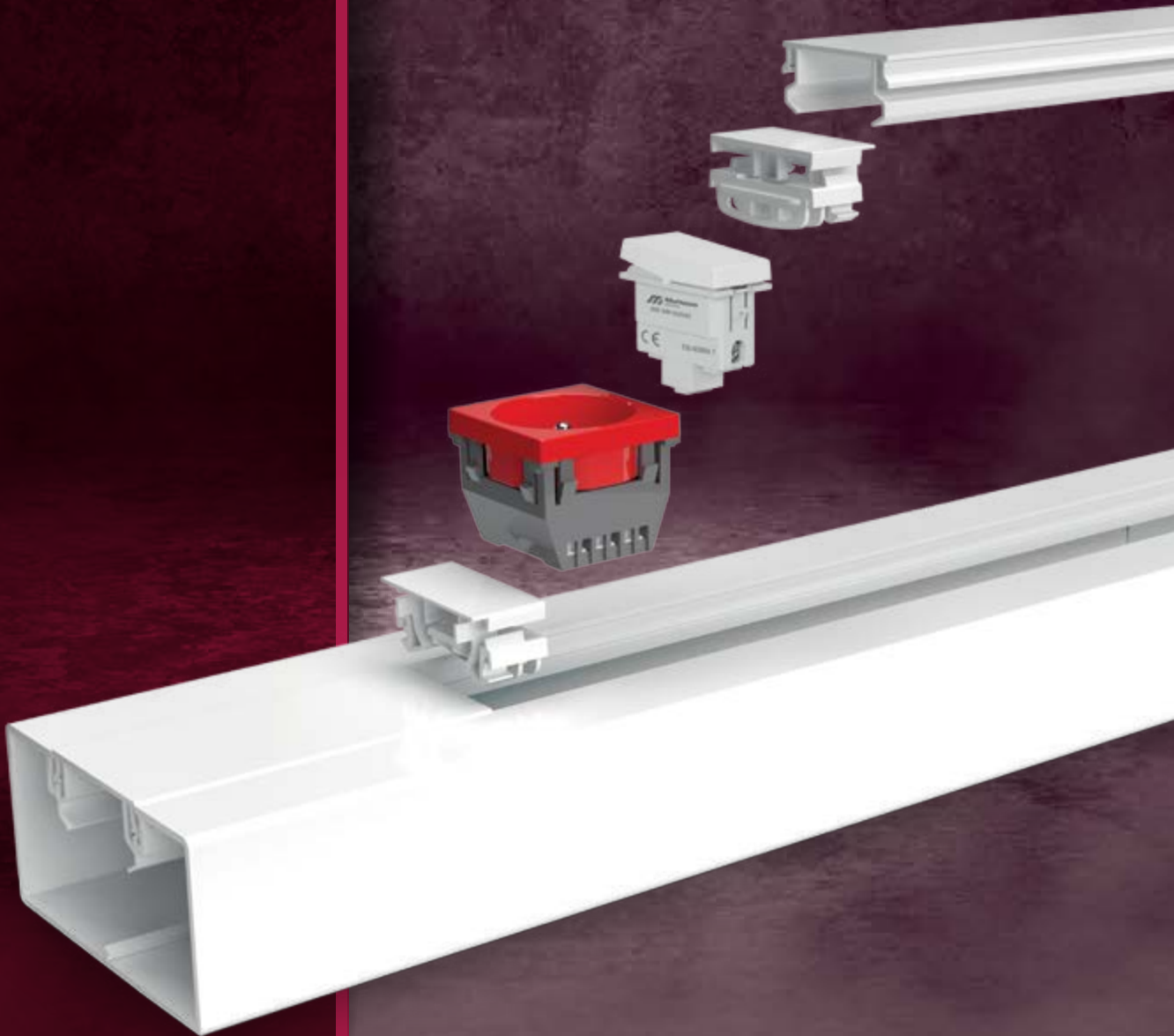

LED



İçin özel
13 mm x 12,5 mm



Ürün Kodu	Ürün Adı	Amb. (Kutu)	Amb. Birimi	Fiyat (₺)
LED İÇİN KENDİNDEN KAPAKLI KABLO KANALI				
001 004 013012 20 44	13x12,5 mm KABLO KANALI ŞEFFAF KANAL (LED İÇİN)	300	m	96,30
CANALEX SERİSİ TSE'Lİ KAPALI TİP KABLO KANALLARI (KUTULU)				
001 156 012012 20 00	12x12 mm KABLO KANALI (CANALEX)	250	m	22,04
001 156 015010 20 00	15x10 mm KABLO KANALI (CANALEX)	250	m	22,53
001 156 016016 20 00	16x16 mm KABLO KANALI (CANALEX)	250	m	24,05
001 156 020010 20 00	20x10 mm KABLO KANALI (CANALEX)	200	m	25,96
001 156 020015 20 00	20x15 mm KABLO KANALI (CANALEX)	200	m	35,75
001 156 025016 20 00	25x16 mm KABLO KANALI (CANALEX)	150	m	36,73
001 156 025025 20 00	25x25 mm KABLO KANALI (CANALEX)	100	m	53,87
001 156 040016 20 00	40x16 mm KABLO KANALI (CANALEX)	100	m	65,13
001 156 040025 20 00	40x25 mm KABLO KANALI (CANALEX)	80	m	71,00
001 156 040040 20 00	40x40 mm KABLO KANALI (CANALEX)	50	m	91,10
001 156 060040 20 00	60x40 mm KABLO KANALI (CANALEX)	40	m	137,11
001 156 060060 20 00	60x60 mm KABLO KANALI (CANALEX)	32	m	210,58
001 156 080040 20 00	80x40 mm KABLO KANALI (CANALEX)	30	m	211,81
001 156 080060 20 00	80x60 mm KABLO KANALI (CANALEX)	24	m	249,75
001 156 100040 20 00	100x40 mm KABLO KANALI (CANALEX)	24	m	259,55
001 156 100060 20 00	100x60 mm KABLO KANALI (CANALEX)	20	m	342,80
CANALEX SERİSİ KAPALI TİP KABLO KANALLARI (YAPIŞKAN BANTLI)				
001 157 012012 20 00	12x12 mm KABLO KANALI CANALEX (YAPIŞKAN BANTLI)	250	m	26,70
001 157 015010 20 00	15x10 mm KABLO KANALI CANALEX (YAPIŞKAN BANTLI)	230	m	27,29
001 157 016016 20 00	16x16 mm KABLO KANALI CANALEX (YAPIŞKAN BANTLI)	240	m	29,13
001 157 020010 20 00	20x10 mm KABLO KANALI CANALEX (YAPIŞKAN BANTLI)	180	m	31,46
001 157 020015 20 00	20x15 mm KABLO KANALI CANALEX (YAPIŞKAN BANTLI)	180	m	43,31
001 157 025016 20 00	25x16 mm KABLO KANALI CANALEX (YAPIŞKAN BANTLI)	150	m	44,50
001 157 025025 20 00	25x25 mm KABLO KANALI CANALEX (YAPIŞKAN BANTLI)	100	m	65,28
001 157 040016 20 00	40x16 mm KABLO KANALI CANALEX (YAPIŞKAN BANTLI)	100	m	78,92
001 157 040025 20 00	40x25 mm KABLO KANALI CANALEX (YAPIŞKAN BANTLI)	80	m	86,04
001 157 040040 20 00	40x40 mm KABLO KANALI CANALEX (YAPIŞKAN BANTLI)	50	m	110,39
001 157 060040 20 00	60x40 mm KABLO KANALI CANALEX (YAPIŞKAN BANTLI)	40	m	166,15
EKO SERİSİ TSE'Lİ KAPALI TİP KABLO KANALLARI				
001 014 010008 20 00	10x08 mm KABLO KANALI EKO	330	m	24,73
001 014 012012 20 00	12x12 mm KABLO KANALI EKO	250	m	24,97
001 014 015010 20 00	15x10 mm KABLO KANALI EKO	250	m	25,30
001 014 015015 20 00	15x15 mm KABLO KANALI EKO	250	m	37,09
001 014 016016 20 00	16x16 mm KABLO KANALI EKO	250	m	34,62
001 014 020010 20 00	20x10 mm KABLO KANALI EKO	200	m	29,49
001 014 025016 20 00	25x16 mm KABLO KANALI EKO	150	m	44,33
001 014 025025 20 00	25x25 mm KABLO KANALI EKO	100	m	58,47
001 014 025040 20 00	25x40 mm KABLO KANALI EKO	80	m	132,20
001 014 930010 20 00	30x10 mm KABLO KANALI EKO (BÖLMELİ)	140	m	65,40
001 014 030015 20 00	30x15 mm KABLO KANALI EKO	140	m	59,50
001 014 930016 20 00	30x16 mm KABLO KANALI EKO (BÖLMELİ)	140	m	83,32
001 014 030016 20 00	30x16 mm KABLO KANALI EKO	140	m	69,42
001 014 030025 20 00	30x25 mm KABLO KANALI EKO	80	m	97,82
001 014 030030 20 00	30x30 mm KABLO KANALI EKO	80	m	88,64
001 014 940016 20 00	40x16 mm KABLO KANALI EKO (BÖLMELİ)	100	m	97,13
001 014 040016 20 00	40x16 mm KABLO KANALI EKO	100	m	71,15
001 014 040025 20 00	40x25 mm KABLO KANALI EKO	80	m	87,84
001 014 040040 20 00	40x40 mm KABLO KANALI EKO	50	m	99,99
001 014 040060 20 00	40x60 mm KABLO KANALI EKO	40	m	259,69
001 014 960025 20 00	60x25 mm KABLO KANALI EKO (BÖLMELİ)	40	m	177,41
001 014 060040 20 00	60x40 mm KABLO KANALI EKO	40	m	159,43
001 014 050050 20 00	50x50 mm KABLO KANALI EKO	30	m	226,66
001 014 060060 20 00	60x60 mm KABLO KANALI EKO	32	m	216,50
001 014 075075 20 00	75x75 mm KABLO KANALI EKO	28	m	360,79
001 014 080040 20 00	80x40 mm KABLO KANALI EKO	30	m	277,50
001 014 080060 20 00	80x60 mm KABLO KANALI EKO	24	m	269,92
001 014 100040 20 00	100x40 mm KABLO KANALI EKO (PRİZ SETİ TAKILABİLİR)	24	m	275,58
001 014 100037 20 00	100x37 mm KABLO KANALI İÇTEN KAPAKLI KANAL EKO FOLYOLU (PRİZ SETİ TAKILABİLİR)	30	m	306,60
001 014 100050 20 00	100x50 mm KABLO KANALI İÇTEN KAPAKLI KANAL EKO FOLYOLU (PRİZ SETİ TAKILABİLİR)	20	m	321,43
001 014 100060 20 00	100x60 mm KABLO KANALI EKO (PRİZ SETİ TAKILABİLİR)	20	m	370,89
001 014 120060 20 00	120x60 mm KABLO KANALI EKO	16	m	543,97
001 014 100100 20 00	100x100 mm KABLO KANALI EKO	20	m	642,86



Ürün Kodu	Ürün Adı	Amb. (Kutu)	Amb. Birimi	Fiyat (₺)
EKO SERİSİ KAPALI TİP KABLO KANALLARI (YAPIŞKAN BANTLI)				
IP40 				
001 004 009005 20 00	9x5 mm KABLO KANALI KENDİNDEN KAPAKLI	500	m	41,09
001 004 010007 20 44	9,5x7 mm KABLO KANALI ŞEFFAF KANAL	500	m	62,21
001 004 012007 20 00	12x7,5 mm KABLO KANALI KENDİNDEN KAPAKLI	350	m	42,17
001 004 013012 20 00	13x12,5 mm KABLO KANALI KENDİNDEN KAPAKLI	300	m	51,10
001 004 010008 20 00	10x8 mm KABLO KANALI EKO (YAPIŞKAN BANTLI)	330	m	28,20
001 004 010010 20 00	10x10 mm KABLO KANALI EKO KENDİNDEN KAPAKLI (YAPIŞKAN BANTLI)	320	m	43,25
001 004 012012 20 00	12x12 mm KABLO KANALI EKO (YAPIŞKAN BANTLI)	250	m	34,39
001 004 015010 20 00	15x10 mm KABLO KANALI EKO (YAPIŞKAN BANTLI)	230	m	35,37
001 004 016016 20 00	16x16 mm KABLO KANALI EKO (YAPIŞKAN BANTLI)	240	m	41,56
001 004 020010 20 00	20x10 mm KABLO KANALI EKO (YAPIŞKAN BANTLI)	180	m	39,29
001 004 025016 20 00	25x16 mm KABLO KANALI EKO (YAPIŞKAN BANTLI)	150	m	59,93
001 004 025025 20 00	25x25 mm KABLO KANALI EKO (YAPIŞKAN BANTLI)	100	m	78,59
001 004 025040 20 00	25x40 mm KABLO KANALI EKO (YAPIŞKAN BANTLI)	80	m	152,25
001 004 930010 20 00	30x10 mm KABLO KANALI EKO (YAPIŞKAN BANTLI) (BÖLMELİ)	140	m	74,65
001 004 030016 20 00	30x16 mm KABLO KANALI EKO (YAPIŞKAN BANTLI)	140	m	78,59
001 004 030025 20 00	30x25 mm KABLO KANALI EKO (YAPIŞKAN BANTLI)	80	m	110,50
001 004 040016 20 00	40x16 mm KABLO KANALI EKO (YAPIŞKAN BANTLI)	100	m	88,41
001 004 040025 20 00	40x25 mm KABLO KANALI EKO (YAPIŞKAN BANTLI)	80	m	112,43
001 004 040040 20 00	40x40 mm KABLO KANALI EKO (YAPIŞKAN BANTLI)	50	m	131,06
001 004 060040 20 00	60x40 mm KABLO KANALI EKO (YAPIŞKAN BANTLI)	40	m	206,29





Ürün Kodu	Ürün Adı	Amb. (Kutu)	Amb. Birimi	Fiyat (₺)
MEKS SERİSİ TSE'Lİ KAPALI TİP KABLO KANALLARI				
TSE CE IP40 				
001 002 015015 20 00	15x15 mm KABLO KANALI MEKS	250	m	44,86
001 002 016016 20 00	16x16 mm KABLO KANALI MEKS	250	m	45,37
001 002 025016 20 00	25x16 mm KABLO KANALI MEKS	150	m	65,54
001 002 025025 20 00	25x25 mm KABLO KANALI MEKS	100	m	85,70
001 002 030015 20 00	30x15 mm KABLO KANALI MEKS	140	m	78,14
001 002 030030 20 00	30x30 mm KABLO KANALI MEKS	80	m	110,90
001 002 040017 20 00	40x17 mm KABLO KANALI TAM KAPAKLI MEKS	100	m	124,53
001 002 940017 20 00	40x17 mm KABLO KANALI TAM KAPAKLI MEKS (BÖLMELİ)	100	m	133,04
001 002 040025 20 00	40x25 mm KABLO KANALI MEKS	80	m	124,68
001 002 040040 20 00	40x40 mm KABLO KANALI MEKS	50	m	145,00
001 002 960025 20 00	60x25 mm KABLO KANALI MEKS (BÖLMELİ)	40	m	216,77
001 002 060040 20 00	60x40 mm KABLO KANALI MEKS	40	m	226,86
001 002 080060 20 00	80x60 mm KABLO KANALI MEKS	24	m	362,97
001 002 100040 20 00	100x40 mm KABLO KANALI MEKS (PRİZ SETİ TAKILABİLİR)	24	m	388,18
001 002 100048 20 00	100x48 mm KABLO KANALI MEKS (PRİZ SETİ TAKILABİLİR)	24	m	504,11
001 002 100060 20 00	100x60 mm KABLO KANALI MEKS (PRİZ SETİ TAKILABİLİR)	20	m	514,20
001 002 120060 20 00	120x60 mm KABLO KANALI MEKS	16	m	705,76
MEKS SERİSİ İÇTEN KAPAKLI KAPALI TİP KABLO KANALLARI				
TSE CE IP40 				
001 002 100037 20 00	100x37 mm KABLO KANALI MEKS (İÇTEN KAPAKLI)(FOLYOLU)	30	m	428,49
001 002 100041 20 00	100x41 mm KABLO KANALI MEKS (İÇTEN KAPAKLI)(FOLYOLU)	24	m	433,54
001 002 100050 20 00	100x50 mm KABLO KANALI MEKS (İÇTEN KAPAKLI)(FOLYOLU)	20	m	453,70
001 002 120070 20 00	120x70 mm KABLO KANALI (İÇTEN KAPAKLI)(AKSESUAR SIZ)	16	m	705,76
001 002 170070 20 00	170x70 mm KABLO KANALI (İÇTEN KAPAKLI)(AKSESUAR SIZ)	12	m	841,87
001 002 250070 20 00	250x70 mm KABLO KANALI (İÇTEN KAPAKLI)(AKSESUAR SIZ)	8	m	1.310,70
MEKSPLUS SERİSİ KAPALI TİP KABLO KANALLARI				
TSE CE IP40 				
001 003 100037 20 00	100x37 mm KABLO KANALI (İÇTEN KAPAKLI)	30	m	453,70
001 003 100041 20 00	100x41 mm KABLO KANALI (İÇTEN KAPAKLI)	24	m	463,79
001 003 100050 20 00	100x50 mm KABLO KANALI (İÇTEN KAP.)(ET KALINLIĞI 2mm)	20	m	504,11
001 006 100050 20 00	100x50 mm KABLO KANALI (İÇTEN KAPAKLI)(KAİDESİZ SERİ)	20	m	626,21
001 003 120070 20 00	120x70 mm KABLO KANALI (İÇTEN KAPAKLI)(AKSESUAR SIZ)	16	m	806,58
001 003 170050 20 00	170x50 mm KABLO KANALI (İÇTEN KAPAKLI)	12	m	1.008,23
001 003 170070 20 00	170x70 mm KABLO KANALI (İÇTEN KAPAKLI)(AKSESUAR SIZ)	12	m	1.235,09
001 003 250070 20 00	250x70 mm KABLO KANALI (İÇTEN KAPAKLI)(AKSESUAR SIZ)	8	m	1.436,73





Ürün Kodu	Ürün Adı	Amb. (Kutu)	Amb. Birimi	Fiyat (₺)
MEKS SERİSİ KLİMA KANALI ve AKSESUARLARI  				
001 002 075060 20 00	75x60 mm KLİMA KANALI	30	m	302,47
001 050 030002 00 00	KLİMA KANALI KABLO TUTUCUSU	60	ad.	51,49
001 043 075060 00 00	KLİMA KANALI EK PARÇASI	40	ad.	51,49
001 039 075060 00 00	KLİMA KANALI İÇ KÖŞE	24	ad.	101,86
001 040 075060 00 00	KLİMA KANALI DIŞ KÖŞE	24	ad.	101,86
001 042 075060 00 00	KLİMA KANALI L KÖŞE	18	ad.	101,86
001 050 030001 00 00	KLİMA KANALI DUVAR GEÇİŞİ	60	ad.	63,67
001 044 075060 01 00	KLİMA KANALI İÇ SONLAMA	30	ad.	101,86
001 044 075060 02 00	KLİMA KANALI DIŞ SONLAMA	18	ad.	101,86



Ürün Kodu	Ürün Adı	Amb. (Kutu)	Amb. Birimi	Fiyat (₺)
TAVAN KÖŞE KANALI (23x23) ve AKSESUARLARI  				
001 002 023023 20 00	23x23 mm TAVAN KÖŞE KANALI	120	m	122,66
001 041 023023 00 00	23x23 mm T PARÇASI	60	ad.	29,67
001 042 023023 00 00	23x23 mm 90 L KÖŞE	60	ad.	29,67
001 043 023023 00 00	23x23 mm EK PARÇA	100	ad.	23,74
001 044 023023 00 00	23x23 mm UÇ TAPA	100	ad.	23,74



Ürün Kodu	Ürün Adı	Amb. (Kutu)	Amb. Birimi	Fiyat (₺)
SÜPÜRGELİK KABLO KANALLARI ve AKSESUARLARI				
001 010 000200 20 00	50'LİK FUGALI SÜPÜRGELİK	60	m	126,39
001 014 974020 20 00	74x20 mm KABLO KANALI EKO (BÖLMELİ)	50	m	241,01
001 039 074020 00 00	74x20 İÇ KÖŞE	20	ad.	75,62
001 040 074020 00 00	74x20 DIŞ KÖŞE	20	ad.	75,62
001 041 074020 00 00	74x20 T KÖŞE	30	ad.	88,21
001 042 074020 01 00	74x90 20 L KÖŞE	40	ad.	88,21
001 043 074020 00 00	74x20 EK PARÇA	50	ad.	42,91
001 044 074020 00 00	74x20 UÇ TAPA	50	ad.	42,91
001 047 017420 00 00	74x20 PRİZ MONTAJ KASASI (55x55)	6	ad.	259,26
001 047 017421 00 00	74x20 1'Lİ PRİZ MONTAJ KASASI (45x45)	12	ad.	429,63
001 002 975022 20 00	75x22 mm KABLO KANALI (BÖLMELİ)	50	m	333,33
001 039 075022 00 00	75x22 mm İÇ KÖŞE	20	ad.	43,21
001 040 075022 00 00	75x22 mm DIŞ KÖŞE	20	ad.	43,21
001 044 075022 01 00	75x22 mm SAĞ SONLAMA	30	ad.	66,27
001 044 075022 02 00	75x22 mm SOL SONLAMA	20	ad.	65,15
001 043 075022 00 00	75x22 mm EK PARÇASI	100	ad.	50,00



Ürün Kodu	Ürün Adı	Amb. (Kutu)	Amb. Birimi	Fiyat (₺)
TEZGAH SÜPÜRGELİĞİ 				
001 011 000100 00 00	25'LİK TEZGAH SÜPÜRGELİĞİ 100CM	60	m	137,04



Ürün Kodu	Ürün Adı	Amb. (Kutu)	Amb. Birimi	Fiyat (₺)
BALIK SIRTI KANALLARI 				
001 002 050013 20 17	50x13 mm BALIK SIRTI KANAL (ZEMİN İÇİN)	60	m	148,15
001 002 060015 20 17	60x15 mm BALIK SIRTI KANAL (ZEMİN İÇİN)	40	m	166,67
001 002 075018 20 17	75x18 mm BALIK SIRTI KANAL (ZEMİN İÇİN)	30	m	277,78
001 002 090020 20 17	90x20 mm BALIK SIRTI KANAL (ZEMİN İÇİN)	20	m	351,85
001 004 050013 20 17	50x13 mm KABLO KANALI BALIK SIRTI (YAPIŞKAN BANTLI)	60	m	166,67
001 004 060015 20 17	60x15 mm KABLO KANALI BALIK SIRTI (YAPIŞKAN BANTLI)	40	m	185,19
001 004 075018 20 17	75x18 mm KABLO KANALI BALIK SIRTI (YAPIŞKAN BANTLI)	30	m	303,70
001 004 090020 20 17	90x20 mm KABLO KANALI BALIK SIRTI (YAPIŞKAN BANTLI)	20	m	374,07

flaret®

HF HALOJEN FREE Flame Retardant Alev Yayımayan



DIŞ KÖŞE



T KÖŞE



L KÖŞE



İÇ KÖŞE



UÇ TAPA





EK PARÇA

Ürün Kodu	Ürün Adı	Amb. (Kutu)	Amb. Birimi	Fiyat (₺)
H.FREE FLARET SERİSİ KAPALI TİP KABLO KANALLARI 				
001 060 100050 20 00	100x50 mm KABLO KANALI İÇTEN KAPAKLI HALOJEN FREE	20	m	1.481,48
001 061 100050 20 00	100x50 mm KABLO KANALI ARA BÖLME HALOJEN FREE	150	m	170,37
001 039 100050 11 00	100x50-37 mm KABLO KANALI İÇ KÖŞE(HAREKETLİ) HALOJEN FREE	12	ad.	151,85
001 040 100050 11 00	100x50 mm KABLO KANALI DIŞ KÖŞE (HAREKETLİ) HALOJEN FREE	10	ad.	151,85
001 041 100050 11 00	100x50 mm KABLO KANALI T PARÇASI HALOJEN FREE	10	ad.	170,37
001 042 100050 11 00	100x50 mm KABLO KANALI 90 L KÖŞE HALOJEN FREE	10	ad.	170,37
001 043 100050 11 00	100x50 mm KABLO KANALI EK PARÇA (ÜÇLÜ SET) HALOJEN FREE	100	ad.	70,37
001 044 100050 11 00	100x50 mm KABLO KANALI UÇ TAPA HALOJEN FREE	40	ad.	70,37
001 047 100001 11 00	PMS(100x37/50)(45X45)(1'Lİ) HALOJEN FREE	30	ad.	129,63
001 047 100002 11 00	PMS(100x37/50)(45X45)(2'Lİ) HALOJEN FREE	16	ad.	166,67
001 047 100003 11 00	PMS(100x37/50)(45X45)(3'LÜ) HALOJEN FREE	14	ad.	222,22

H.FREE FLARET SERİSİ KAPALI TİP KABLO KANALLARI 				
001 060 025016 20 00	25x16 mm KABLO KANALI HALOJEN FREE	150	m	277,78
001 060 025025 20 00	25x25 mm KABLO KANALI HALOJEN FREE	100	m	314,81
001 060 040025 20 00	40x25 mm KABLO KANALI HALOJEN FREE	80	m	462,96
001 060 040040 20 00	40x40 mm KABLO KANALI HALOJEN FREE	50	m	537,04

25x16 H.FREE FLARET KANAL AKSESUARLARI 				
001 039 025016 11 00	25x16 mm İÇ KÖŞE	40	ad.	35,19
001 040 025016 11 00	25x16 mm DIŞ KÖŞE	40	ad.	35,19
001 041 025016 11 00	25x16 mm T PARÇASI	30	ad.	55,56
001 042 025016 11 00	25x16 mm 90 L KÖŞE	80	ad.	55,56
001 043 025016 11 00	25x16 mm EK PARÇA	100	ad.	33,33
001 044 025016 11 00	25x16 mm UÇ TAPA	100	ad.	33,33

25x25 H.FREE FLARET KANAL AKSESUARLARI 				
001 039 025025 11 00	25x25 mm İÇ KÖŞE	40	ad.	40,74
001 040 025025 11 00	25x25 mm DIŞ KÖŞE	40	ad.	40,74
001 041 025025 11 00	25x25 mm T PARÇASI	30	ad.	62,96
001 042 025025 11 00	25x25 mm 90 L KÖŞE	50	ad.	62,96
001 043 025025 11 00	25x25 mm EK PARÇA	100	ad.	37,04
001 044 025025 11 00	25x25 mm UÇ TAPA	100	ad.	37,04

40x25 H.FREE FLARET KANAL AKSESUARLARI 				
001 039 040025 11 00	40x25 mm İÇ KÖŞE	24	ad.	92,59
001 040 040025 11 00	40x25 mm DIŞ KÖŞE	30	ad.	92,59
001 041 040025 11 00	40x25 mm T PARÇASI	18	ad.	103,70
001 042 040025 11 00	40x25 mm 90 L KÖŞE	24	ad.	103,70
001 043 040025 11 00	40x25 mm EK PARÇA	70	ad.	74,07
001 044 040025 11 00	40x25 mm UÇ TAPA	25	ad.	74,07

40x40 H.FREE FLARET KANAL AKSESUARLARI 				
001 039 040040 11 00	40x40 mm İÇ KÖŞE	18	ad.	96,30
001 040 040040 11 00	40x40 mm DIŞ KÖŞE	16	ad.	96,30
001 041 040040 11 00	40x40 mm T PARÇASI	48	ad.	107,41
001 042 040040 11 00	40x40 mm 90 L KÖŞE	60	ad.	107,41
001 043 040040 11 00	40x40 mm EK PARÇA	100	ad.	77,78
001 044 040040 11 00	40x40 mm UÇ TAPA	25	ad.	77,78



EK PARÇA



T KÖŞE



İÇ KÖŞE



DIŞ KÖŞE



















L KÖŞE



UÇ TAPA



Ürün Kodu	Ürün Adı	Amb. (Kutu)	Amb. Birimi	Fiyat (₺)
BALIK SIRTI 60x15 AKSESUARLARI				
001 042 060015 00 17	60x15 mm BALIK SIRTI KANAL L KÖŞE	24	ad.	66,67
001 043 060015 00 17	60x15 mm BALIK SIRTI KANAL EK PARÇASI	50	ad.	31,48
001 044 060015 00 17	60x15 mm BALIK SIRTI KANAL SONLAMA KAPAĞI	50	ad.	31,48
001 041 060015 00 17	60x15 mm BALIK SIRTI KANAL T KÖŞE	10	ad.	66,67
BALIK SIRTI 75x18 AKSESUARLARI				
001 042 075018 00 17	75x18 mm BALIK SIRTI KANAL L KÖŞE	15	ad.	81,48
001 043 075018 00 17	75x18 mm BALIK SIRTI KANAL EK PARÇASI	50	ad.	37,04
001 044 075018 00 17	75x18 mm BALIK SIRTI KANAL SONLAMA KAPAĞI	50	ad.	37,04
001 041 075018 00 17	75x18 mm BALIK SIRTI KANAL T KÖŞE	8	ad.	81,48
BALIK SIRTI 90x20 AKSESUARLARI				
001 042 090020 00 17	90x20 mm BALIK SIRTI KANAL KANAL L KÖŞE	20	ad.	92,59
001 043 090020 00 17	90x20 mm BALIK SIRTI KANAL EK PARÇASI	50	ad.	40,74
001 044 090020 00 17	90x20 mm BALIK SIRTI KANAL SONLAMA KAPAĞI	50	ad.	40,74
001 041 090020 00 17	90x20 mm BALIK SIRTI KANAL T KÖŞE	12	ad.	92,59
12X12 KANAL AKSESUARLARI IP40				
001 039 012012 00 00	12x12 mm İÇ KÖŞE	60	ad.	25,93
001 040 012012 00 00	12x12 mm DIŞ KÖŞE	60	ad.	25,93
001 041 012012 00 00	12x12 mm T KÖŞE	60	ad.	27,78
001 042 012012 00 00	12x12 mm 90 L KÖŞE	60	ad.	27,78
001 044 012012 00 00	12x12 mm UÇ TAPA	100	ad.	25,00
001 043 012012 00 00	12x12 mm EK PARÇASI	100	ad.	25,00
15X10 KANAL AKSESUARLARI IP40				
001 039 015010 00 00	15x10 mm İÇ KÖŞE	60	ad.	25,93
001 040 015010 00 00	15x10 mm DIŞ KÖŞE	60	ad.	25,93
001 041 015010 00 00	15x10 mm T KÖŞE	60	ad.	27,78
001 042 015010 00 00	15x10 mm 90 L KÖŞE	60	ad.	27,78
001 044 015010 00 00	15x10 mm UÇ TAPA	100	ad.	25,00
001 043 015010 00 00	15x10 mm EK PARÇASI	100	ad.	25,00
20X10 KANAL AKSESUARLARI IP40				
001 039 020010 00 00	20x10 mm İÇ KÖŞE	60	ad.	25,93
001 040 020010 00 00	20x10 mm DIŞ KÖŞE	60	ad.	25,93
001 041 020010 00 00	20x10 mm T KÖŞE	30	ad.	27,78
001 042 020010 00 00	20x10 mm 90 L KÖŞE	50	ad.	27,78
001 044 020010 00 00	20x10 mm UÇ TAPA	100	ad.	25,00
001 043 020010 00 00	20x10 mm EK PARÇASI	100	ad.	25,00
16X16 KANAL AKSESUARLARI IP40				
001 039 016016 00 00	16x16 mm İÇ KÖŞE	100	ad.	25,93
001 040 016016 00 00	16x16 mm DIŞ KÖŞE	100	ad.	25,93
001 041 016016 00 00	16x16 mm T KÖŞE	60	ad.	31,48
001 042 016016 00 00	16x16 mm 90 L KÖŞE	60	ad.	31,48
001 044 016016 00 00	16x16 mm UÇ TAPA	100	ad.	25,00
001 043 016016 00 00	16x16 mm EK PARÇASI	100	ad.	25,00
25X16 KANAL AKSESUARLARI IP40				
001 039 025016 00 00	25x16 mm İÇ KÖŞE	40	ad.	27,78
001 040 025016 00 00	25x16 mm DIŞ KÖŞE	40	ad.	27,78
001 041 025016 00 00	25x16 mm T KÖŞE	30	ad.	44,44
001 042 025016 00 00	25x16 mm 90 L KÖŞE	80	ad.	44,44
001 044 025016 00 00	25x16 mm UÇ TAPA	100	ad.	27,78
001 043 025016 00 00	25x16 mm EK PARÇASI	100	ad.	27,78
001 047 017421 00 00	25X16 mm PMK (45x45)	12	ad.	429,63
25X25 KANAL AKSESUARLARI IP40				
001 039 025025 00 00	25x25 mm İÇ KÖŞE	40	ad.	35,20
001 040 025025 00 00	25x25 mm DIŞ KÖŞE	40	ad.	35,20
001 041 025025 00 00	25x25 mm T KÖŞE	24	ad.	58,66
001 042 025025 00 00	25x25 mm 90 L KÖŞE	40	ad.	58,66
001 044 025025 00 00	25x25 mm UÇ TAPA	100	ad.	32,78
001 043 025025 00 00	25x25 mm EK PARÇASI	50	ad.	32,78
001 047 017421 00 00	25x25 mm PMK (45x45)	12	ad.	429,63

Ürün Kodu	Ürün Adı	Amb. (Kutu)	Amb. Birimi	Fiyat (₺)
30X10 KANAL AKSESUARLARI  				
001 039 030010 00 00	30x10 mm İÇ KÖŞE	50	ad.	48,31
001 040 030010 00 00	30x10 mm DIŞ KÖŞE	50	ad.	48,31
001 041 030010 00 00	30x10 mm T KÖŞE	50	ad.	62,12
001 042 030010 00 00	30x10 mm 90 L KÖŞE	50	ad.	62,12
001 044 030025 00 00	30x10-16-25 mm UÇ TAPA	100	ad.	51,76
001 043 030025 00 00	30x10-16-25 mm EK PARÇASI	100	ad.	51,76
30X16 KANAL AKSESUARLARI  				
001 039 030016 00 00	30x16 mm İÇ KÖŞE	35	ad.	72,22
001 040 030016 00 00	30x16 mm DIŞ KÖŞE	48	ad.	72,22
001 041 030016 00 00	30x16 mm T KÖŞE	40	ad.	77,78
001 042 030016 00 00	30x16 mm 90 L KÖŞE	50	ad.	77,78
001 044 030025 00 00	30x10-16-25 mm UÇ TAPA	100	ad.	51,74
001 043 030025 00 00	30x10-16-25 mm EK PARÇASI	100	ad.	51,74
30X25 KANAL AKSESUARLARI  				
001 039 030025 00 00	30x25 mm İÇ KÖŞE	30	ad.	72,22
001 040 030025 00 00	30x25 mm DIŞ KÖŞE	32	ad.	72,22
001 041 030025 00 00	30x25 mm T KÖŞE	24	ad.	77,78
001 042 030025 00 00	30x25 mm 90 L KÖŞE	30	ad.	77,78
001 044 030025 00 00	30x10-16-25 mm UÇ TAPA	100	ad.	51,74
001 043 030025 00 00	30x10-16-25 mm EK PARÇASI	100	ad.	51,74
40X16 KANAL AKSESUARLARI  				
001 039 040016 00 00	40x16 mm İÇ KÖŞE	32	ad.	59,26
001 040 040016 00 00	40x16 mm DIŞ KÖŞE	30	ad.	59,26
001 041 040016 00 00	40x16 mm T KÖŞE	24	ad.	66,67
001 042 040016 00 00	40x16 mm 90 L KÖŞE	34	ad.	66,67
001 044 040040 00 00	40x16-25-40 mm UÇ TAPA	25	ad.	51,85
001 043 040016 00 00	40x16-25-40 mm EK PARÇASI	100	ad.	51,85
001 047 017421 00 00	40x16 mm PMK (45x45)	12	ad.	429,63
40X25 KANAL AKSESUARLARI  				
001 039 040025 00 00	40x25 mm İÇ KÖŞE	24	ad.	62,96
001 040 040025 00 00	40x25 mm DIŞ KÖŞE	30	ad.	62,96
001 041 040025 00 00	40x25 mm T KÖŞE	18	ad.	70,37
001 042 040025 00 00	40x25 mm 90 L KÖŞE	24	ad.	70,37
001 044 040040 00 00	40x16-25-40 mm UÇ TAPA	25	ad.	51,85
001 043 040016 00 00	40x16-25-40 mm EK PARÇASI	100	ad.	51,85
001 047 017421 00 00	40x25 mm PMK (45x45)	12	ad.	429,63
40X40 KANAL AKSESUARLARI  				
001 039 040040 01 00	40x40 mm İÇ KÖŞE (HAREKETLİ)	18	ad.	62,96
001 040 040040 01 00	40x40 mm DIŞ KÖŞE (HAREKETLİ)	16	ad.	62,96
001 041 040040 00 00	40x40 mm T KÖŞE	48	ad.	70,37
001 042 040040 00 00	40x40 mm 90 L KÖŞE	60	ad.	70,37
001 044 040040 00 00	40x16-25-40 mm UÇ TAPA	50	ad.	51,85
001 043 040016 00 00	40x16-25-40 mm EK PARÇASI	100	ad.	51,85
001 047 017421 00 00	40x40 mm PMK (45x45)	12	ad.	429,63
60X25 KANAL AKSESUARLARI  				
001 039 060025 00 00	60x25 mm İÇ KÖŞE	48	ad.	68,52
001 040 060025 00 00	60x25 mm DIŞ KÖŞE	72	ad.	68,52
001 041 060025 00 00	60x25 mm T KÖŞE	40	ad.	81,48
001 042 060025 00 00	60x25 mm 90 L KÖŞE	60	ad.	81,48
001 044 060025 00 00	60x25 mm UÇ TAPA	50	ad.	51,85
001 043 060025 00 00	60x25 mm EK PARÇASI	60	ad.	51,85
60X40 KANAL AKSESUARLARI  				
001 039 060040 00 00	60x40 mm İÇ KÖŞE	26	ad.	85,19
001 040 060040 00 00	60x40 mm DIŞ KÖŞE	32	ad.	85,19
001 041 060040 00 00	60x40 mm T KÖŞE	32	ad.	88,89
001 042 060040 00 00	60x40 mm 90 L KÖŞE	40	ad.	88,89
001 044 060040 00 00	60x40 mm UÇ TAPA	50	ad.	51,85
001 043 060040 00 00	60x40 mm EK PARÇASI	40	ad.	51,85



UÇ TAPA



T KÖŞE



İÇ KÖŞE



EK PARÇA

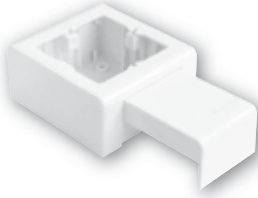

PRİZ MONTAJ KASASI



EK PARÇA



T KÖŞE

Ürün Kodu	Ürün Adı	Amb. (Kutu)	Amb. Birimi	Fiyat (₺)
60X60 KANAL AKSESUARLARI IP40				
001 039 060060 01 00	60x60 mm İÇ KÖŞE (HAREKETLİ)	16	ad.	111,11
001 040 060060 01 00	60x60 mm DIŞ KÖŞE (HAREKETLİ)	16	ad.	111,11
001 041 060060 00 00	60x60 mm T KÖŞE	20	ad.	144,44
001 042 060060 00 00	60x60 mm 90 L KÖŞE	24	ad.	144,44
001 044 060060 00 00	60x60 mm UÇ TAPA	30	ad.	77,78
001 043 060060 00 00	60x60 mm EK PARÇASI	25	ad.	77,78
80X40 KANAL AKSESUARLARI IP40				
001 039 080040 00 00	80x40 mm İÇ KÖŞE	18	ad.	129,63
001 040 080040 00 00	80x40 mm DIŞ KÖŞE	8	ad.	129,63
001 041 080040 00 00	80x40 mm T KÖŞE	12	ad.	148,15
001 042 080040 00 00	80x40 mm 90 L KÖŞE	16	ad.	148,15
001 044 080040 00 00	80x40 mm UÇ TAPA	60	ad.	100,00
001 043 080040 00 00	80x40 mm EK PARÇASI	100	ad.	100,00
80X60 KANAL AKSESUARLARI IP40				
001 039 080060 00 00	80x60 mm İÇ KÖŞE	12	ad.	137,04
001 040 080060 00 00	80x60 mm DIŞ KÖŞE	8	ad.	137,04
001 041 080060 00 00	80x60 mm T KÖŞE	10	ad.	155,56
001 042 080060 00 00	80x60 mm 90 L KÖŞE	12	ad.	155,56
001 044 080060 00 00	80x60 mm UÇ TAPA	48	ad.	107,41
001 043 080060 00 00	80x60 mm EK PARÇASI	80	ad.	107,41
100X37 KANAL AKSESUARLARI IP40				
001 039 100037 00 00	100x37 mm İÇ KÖŞE (SABİT)	12	ad.	111,11
001 040 100037 00 00	100x37 mm DIŞ KÖŞE (SABİT)	8	ad.	111,11
001 039 100037 01 00	100x37 mm İÇ KÖŞE (HAREKETLİ)	12	ad.	111,11
001 040 100037 01 00	100x37 mm DIŞ KÖŞE (HAREKETLİ)	10	ad.	111,11
001 041 100037 00 00	100x37 mm T PARÇASI	14	ad.	118,52
001 042 100037 00 00	100x37 mm 90 L KÖŞE	14	ad.	118,52
001 044 100037 00 00	100x37 mm UÇ TAPA	50	ad.	59,26
001 043 100037 00 00	100x37 mm EK PARÇA	100	ad.	59,26
001 050 030003 00 00	100X37/41/50 mm KANAL KİLİTLEME APARATI	75	ad.	22,22
100X40 KANAL AKSESUARLARI IP40				
001 039 100040 00 00	100x40 mm İÇ KÖŞE (SABİT)	8	ad.	133,33
001 040 100040 00 00	100x40 mm DIŞ KÖŞE (SABİT)	8	ad.	133,33
001 039 100040 01 00	100x40 mm İÇ KÖŞE (HAREKETLİ)	16	ad.	133,33
001 040 100040 01 00	100x40 mm DIŞ KÖŞE (HAREKETLİ)	10	ad.	133,33
001 041 100040 00 00	100x40 mm T PARÇASI	12	ad.	162,96
001 042 100040 00 00	100x40 mm 90 L KÖŞE	12	ad.	162,96
001 044 100060 00 00	100x40 mm UÇ TAPA	20	ad.	66,67
001 043 100060 00 00	100x40 mm EK PARÇA	100	ad.	66,67
001 050 030004 00 00	100x40 mm KANAL KİLİTLEME APARATI	100	ad.	22,22
001 013 100040 20 00	100x40 mm ARA BÖLME	200	mt.	92,59
100X48 KANAL AKSESUARLARI IP40				
001 039 100048 00 00	100X48 mm İÇ KÖŞE (SABİT)	8	ad.	137,04
001 040 100048 00 00	100X48 mm DIŞ KÖŞE (SABİT)	8	ad.	137,04
001 039 100048 01 00	100X48 mm İÇ KÖŞE (HAREKETLİ)	10	ad.	137,04
001 040 100048 01 00	100X48 mm DIŞ KÖŞE (HAREKETLİ)	10	ad.	137,04
001 041 100048 00 00	100X48 mm T PARÇASI	8	ad.	166,67
001 042 100048 00 00	100X48 mm 90 L KÖŞE	8	ad.	166,67
001 044 100060 00 00	100X48 mm UÇ TAPA	20	ad.	66,67
001 043 100060 00 00	100X48 mm EK PARÇA	100	ad.	66,67
001 050 030004 00 00	100X48 mm KANAL KİLİTLEME APARATI	100	ad.	22,22
001 013 100048 20 00	100X48 mm ARA BÖLME	150	mt.	74,07
100X50/41 KANAL AKSESUARLARI IP40				
001 039 100050 00 00	100X50/41 mm İÇ KÖŞE (SABİT)	8	ad.	83,52
001 040 100050 00 00	100X50/41 mm DIŞ KÖŞE (SABİT)	8	ad.	83,52
001 039 100050 01 00	100X50/41 mm İÇ KÖŞE (HAREKETLİ)	10	ad.	83,52
001 040 100050 01 00	100X50/41 mm DIŞ KÖŞE (HAREKETLİ)	8	ad.	83,52
001 041 100050 00 00	100X50/41 mm T PARÇASI	10	ad.	103,70
001 042 100050 00 00	100X50/41 mm 90 L KÖŞE	10	ad.	103,70
001 044 100050 00 00	100X50/41 mm UÇ TAPA	40	ad.	59,26
001 043 100050 00 00	100X50/41 mm EK PARÇA	100	ad.	59,26
001 043 100050 01 00	100X50 mm EK PARÇA (3'LÜ SET)	100	ad.	70,37
001 046 195100 00 00	100X50 mm KANAL İÇİ KÜP BUAT	25	ad.	88,89
001 013 100048 20 00	100X48 - 100X50 mm ARA BÖLME	150	mt.	74,07
001 050 030003 00 00	100X37/41/50 mm KANAL KİLİTLEME APARATI	75	ad.	22,22

Ürün Kodu	Ürün Adı	Amb. (Kutu)	Amb. Birimi	Fiyat (₺)
100X50 KAİDESİZ KANAL AKSESUARLARI TS CE IP40				
001 039 100051 00 00	100X50 mm KAİDESİZ İÇ KÖŞE	8	ad.	92,59
001 040 100051 00 00	100X50 mm KAİDESİZ DIŞ KÖŞE	8	ad.	92,59
001 041 100051 00 00	100X50 mm KAİDESİZ T PARÇASI	10	ad.	129,63
001 042 100051 00 00	100X50 mm KAİDESİZ 90 L KÖŞE	10	ad.	129,63
001 043 100051 00 00	100X50 mm KAİDESİZ EK PARÇA	100	ad.	81,48
001 044 100051 00 00	100X50 mm KAİDESİZ UÇ TAPA	40	ad.	81,48
001 888 100050 00 00	100X50 mm KABLO KANALI MONTAJ APARATI	50	ad.	85,19
100X60 KANAL AKSESUARLARI TS CE IP40				
001 039 100060 00 00	100X60 mm İÇ KÖŞE (SABİT)	8	ad.	137,04
001 040 100060 00 00	100X60 mm DIŞ KÖŞE (SABİT)	8	ad.	137,04
001 039 100060 01 00	100X60 mm İÇ KÖŞE (HAREKETLİ)	8	ad.	137,04
001 040 100060 01 00	100X60 mm DIŞ KÖŞE (HAREKETLİ)	10	ad.	137,04
001 041 100060 00 00	100X60 mm T PARÇASI	8	ad.	155,56
001 042 100060 00 00	100X60 mm 90 L KÖŞE	8	ad.	155,56
001 044 100060 00 00	100X60 mm UÇ TAPA	16	ad.	66,67
001 043 100060 00 00	100X60 mm EK PARÇA	100	ad.	66,67
001 050 030004 00 00	100X60 mm KANAL KİLİTLEME APARATI	100	ad.	22,22
001 013 100060 20 00	100X60 mm ARA BÖLME	130	ad.	98,15
120X60 KANAL AKSESUARLARI TS CE IP40				
001 039 120060 00 00	120X60 mm İÇ KÖŞE	8	ad.	148,15
001 040 120060 00 00	120X60 mm DIŞ KÖŞE	8	ad.	148,15
001 041 120060 00 00	120X60 mm T PARÇA	8	ad.	155,56
001 042 120060 00 00	120X60 mm 90 L KÖŞE	8	ad.	155,56
001 044 120060 00 00	120X60 mm UÇ TAPA	20	ad.	48,15
001 043 120060 00 00	120X60 mm EK PARÇA	50	ad.	48,15
170X50 KANAL AKSESUARLARI TS CE IP40				
001 039 170050 00 00	170X50 mm İÇ KÖŞE	32	ad.	177,78
001 040 170050 00 00	170X50 mm DIŞ KÖŞE	44	ad.	177,78
001 041 170050 00 00	170X50 mm T PARÇA	16	ad.	211,11
001 042 170050 00 00	170X50 mm 90 L KÖŞE	16	ad.	211,11
001 044 170050 00 00	170X50 mm UÇ TAPA	125	ad.	59,26
001 043 170050 00 00	170X50 mm EK PARÇA	125	ad.	59,26
İÇTEN KAPAKLI 100X37/50 İÇİN PRİZ MONTAJ SETİ (45x45) TS CE IP40				
001 047 070001 00 00	100X37/50 İÇİN 45X45 PMS (TEKLİ)	30	ad.	77,78
001 047 070002 00 00	100X37/50 İÇİN 45X45 PMS (İKİLİ)	16	ad.	90,74
001 047 070003 00 00	100X37/50 İÇİN 45X45 PMS (ÜÇLÜ)	14	ad.	100,00
001 047 070004 00 00	100X37/50 İÇİN 45X45 PMS (DÖRTLÜ)	13	ad.	185,19
İÇTEN KAPAKLI 100X37/50 İÇİN PRİZ MONTAJ SETİ (55X55)				
001 047 080001 00 00	100X37/50 İÇİN 55X55 PMS (TEKLİ)	20	ad.	122,22
001 047 080002 00 00	100X37/50 İÇİN 55X55 PMS (İKİLİ)	14	ad.	196,30
001 047 080003 00 00	100X37/50 İÇİN 55X55 PMS (ÜÇLÜ)	12	ad.	233,33
DIŞTAN KAPAKLI 100'LÜK KANAL PRİZ MONTAJ SETİ (55X55)				
001 047 020001 00 00	100'LÜK 55X55 PMS TEKLİ	20	ad.	177,78
001 047 020002 00 00	100'LÜK 55X55 PMS İKİLİ	14	ad.	222,22
001 047 020003 00 00	100'LÜK 55X55 PMS ÜÇLÜ	12	ad.	277,78
DIŞTAN KAPAKLI 100'LÜK KANAL PRİZ MONTAJ SETİ (45x45) TS CE IP40				
001 047 040001 00 00	100'LÜK 45X45 PMS TEKLİ	20	ad.	144,44
001 047 040002 00 00	100'LÜK 45X45 PMS İKİLİ	14	ad.	207,41
001 047 040003 00 00	100'LÜK 45X45 PMS ÜÇLÜ	12	ad.	296,30
001 047 040004 00 00	100'LÜK 45X45 PMS DÖRTLÜ	10	ad.	333,33
İNGİLİZ NORMU PRİZ MONTAJ SETLERİ (100x50/37)				
001 047 980001 00 00	İNGİLİZ NORMU TEKLİ PRİZ TABANI	200	ad.	85,19
001 047 980002 00 00	İNGİLİZ NORMU İKİLİ PRİZ TABANI	100	ad.	88,89
001 047 990002 00 00	İNGİLİZ NORMU İKİLİ YÜKSEK TİP PRİZ TABANI	94	ad.	148,15
001 166 000001 00 00	SIVA ALTI ANAHTAR KASASI	28	ad.	75,93

001 046 195100 00 00

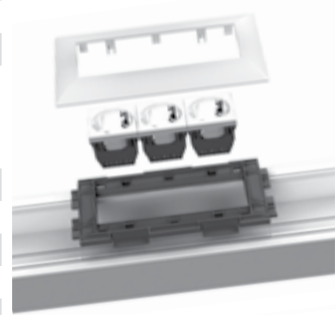
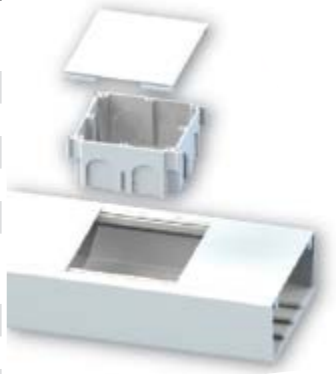



001 052 300001 00 00 001 052 300002 00 00

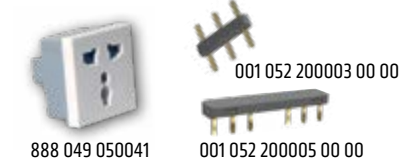

888 049 050041 001 052 200003 00 00 001 052 200005 00 00



888 049 050061 888 049 050074

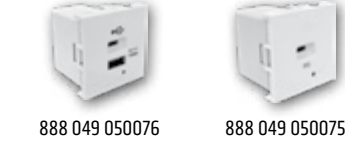

888 049 050076 888 049 050075



888 049 050040 888 049 050043



888 049 050042



888 049 050051 888 049 050055



888 049 050013 888 049 050008



888 049 050058 888 049 050047



888 049 050056 888 049 050049



KANAL İÇİN UPS VE ENERJİ PRİZLERİ

CE

Kod	Ürün Tanımı	Kutu Adedi	Koli Adedi	Fiyat (₺)
001 052 300001 00 00	45X45 TOPRAKLI PRİZ ÇEKİRDEĞİ ÇOCUK KORUMALI (45°)	50	300	185,19
001 052 300002 00 00	45X45 UPS PRİZ ÇEKİRDEĞİ ÇOCUK KORUMALI (45°)	50	300	185,19
001 052 200003 00 00	45X45 PRİZ BİRLEŞTİRME APARATI (YANDAN)	50	500	48,15
001 052 200005 00 00	45X45 PRİZ BİRLEŞTİRME APARATI	50	500	103,70
888 049 050041	45X45 UNİVERSAL PRİZ	10	200	5,90 \$

KANAL İÇİN ŞARJ PRİZLERİ

CE

Kod	Ürün Tanımı	Kutu Adedi	Koli Adedi	Fiyat (\$)
888 049 050061	45X22,5 USB ŞARJ PRİZİ 5V 2,1A	10	200	22,04 \$
888 049 050062	45X22,5 2'Lİ USB ŞARJ PRİZİ 5V 2,1A	20	200	24,89 \$
888 049 050074	45X45 ŞARJ PRİZİ TYPE-C+TYPE-C (C+C) 5V 4.2A	10	200	28,30 \$
888 049 050075	45X45 ŞARJ PRİZİ TYPE-C (C) 5V 3A	10	200	21,43 \$
888 049 050076	45X45 ŞARJ PRİZİ USB+TYPE-C (A+C) 5V 4.2A	10	200	27,54 \$

KANAL İÇİN ANAHTARLAR

CE

Kod	Ürün Tanımı	Kutu Adedi	Koli Adedi	Fiyat (\$)
888 049 050040	45X22,5 ANAHTAR	20	400	3,36 \$
888 049 050043	45X22,5 VAVİEN	20	400	3,90 \$
888 049 050063	45X45 ANAHTAR	10	200	4,81 \$
888 049 050044	45X45 YAYLI ÇAĞIRMA (LIGHT)	10	200	4,81 \$
888 049 050064	45X45 ARA VAVİEN	10	200	6,60 \$
888 049 050065	45X45 VAVİEN	10	200	5,10 \$
888 049 050042	45X45 KOMİTATÖR	10	200	5,90 \$

KANAL İÇİN KONNEKTÖRLER

CE

Kod	Ürün Tanımı	Kutu Adedi	Koli Adedi	Fiyat (\$)
888 049 050051	45X22,5 KÖR KAPAK	100	1000	0,35 \$
888 049 050055	45X45 KÖR KAPAK	100	400	0,36 \$
888 049 050012	45X22,5 KEYSTONE JACK PANJURLU KAPAK	100	1000	0,47 \$
888 049 050013	45X45 KEYSTONE JACK PANJURLU KAPAK	100	500	0,65 \$
888 049 050008	DATA KONNEKTÖRÜ CAT5E (RJ45)	100	1000	1,23 \$
888 049 050032	DATA KONNEKTÖRÜ CAT6E (RJ65 8)	100	1000	1,25 \$
888 049 050009	TELEFON KONNEKTÖRÜ CAT3 (RJ 11)	100	1000	1,23 \$
888 049 050058	45X22,5 USB 2.0 - AF/AF DATA 90 GİRİŞ	50	500	3,08 \$
888 049 050059	45X22,5 USB 2.0 - AF/AF DATA 180 GİRİŞ	50	500	3,08 \$

KANAL İÇİN GÖRÜNTÜ ve SES PRİZLERİ

CE

Kod	Ürün Tanımı	Kutu Adedi	Koli Adedi	Fiyat (\$)
888 049 050046	45X22,5 HDMI 90 GİRİŞ	50	500	8,76 \$
888 049 050047	45X22,5 VGA DATA JACK	50	500	4,98 \$
888 049 050056	45X22,5 TV PRİZİ ERKEK	50	500	2,23 \$
888 049 050057	45X22,5 TV PRİZİ DIŞI	50	500	2,33 \$
888 049 050049	45X22,5 RCA	50	500	5,49 \$
888 049 050060	45X22,5 SES JAKI 3,5 mm STEREO	50	500	3,02 \$

RACK KABİN ve AKSESUARLARI

Kod	Ürün Tanımı	Kutu Adedi	Koli Adedi	Fiyat (₺)
075 171 222508	16 MODÜL DÖŞEME ALTI PRİZ SİSTEM (BOŞ) 270X270	1	10	2.037,04
075 171 333308	16 MODÜL DÖŞEME ALTI PRİZ SİSTEM BUATI 352X352	1	5	2.007,41

SİDEM SERİSİ RENKLİ KABLO KANALLARI



Ürün Kodu	Ürün Adı	Amb. (Kutu)	Amb. Birimi	Fiyat (₺)
001 007 010008 20 XX	10X8 mm KABLO KANALI (SİDEM)	330	m	88,89
001 007 012012 20 XX	12X12 mm KABLO KANALI (SİDEM)	250	m	88,89
001 007 015010 20 XX	15X10 mm KABLO KANALI (SİDEM)	250	m	88,89
001 007 016016 20 XX	16X16 mm KABLO KANALI (SİDEM)	250	m	111,11
001 007 020010 20 XX	20X10 mm KABLO KANALI (SİDEM)	200	m	88,89
001 007 025016 20 XX	25X16 mm KABLO KANALI (SİDEM)	150	m	137,04
001 007 025025 20 XX	25X25 mm KABLO KANALI (SİDEM)	100	m	170,37
001 007 930010 20 XX	30X10 mm KABLO KANALI (SİDEM) BÖLMELİ	140	m	151,85
001 007 930016 20 XX	30X16 mm KABLO KANALI (SİDEM) BÖLMELİ	140	m	200,00
001 007 030025 20 XX	30X25 mm KABLO KANALI (SİDEM)	80	m	225,00
001 007 040016 20 XX	40X16 mm KABLO KANALI (SİDEM)	100	m	185,19
001 007 940016 20 XX	40X16 mm KABLO KANALI (SİDEM) (BÖLMELİ)	100	m	225,00
001 007 040025 20 XX	40X25 mm KABLO KANALI (SİDEM)	80	m	250,01
001 007 040040 20 XX	40X40 mm KABLO KANALI (SİDEM)	50	m	275,00
001 007 960025 20 XX	60X25 mm KABLO KANALI (SİDEM) BÖLMELİ	40	m	400,01
001 007 060040 20 XX	60X40 mm KABLO KANALI (SİDEM)	40	m	375,00
001 007 060060 20 XX	60X60 mm KABLO KANALI (SİDEM)	32	m	599,99
001 007 080040 20 XX	80X40 mm KABLO KANALI (SİDEM)	30	m	599,99
001 007 080060 20 XX	80X60 mm KABLO KANALI (SİDEM)	24	m	650,00
001 007 100040 20 XX	100X40 mm KABLO KANALI (SİDEM)	24	m	700,00
001 007 100048 20 XX	100X48 mm KABLO KANALI (SİDEM)	24	m	700,00
001 007 100060 20 XX	100X60 mm KABLO KANALI (SİDEM)	20	m	950,00
001 007 075060 20 XX	75X60 mm KABLO KANALI (SİDEM)	30	m	650,00
001 007 100037 20 XX	100X37 mm KABLO KANALI (SİDEM) İ.KAPAKLI	30	m	750,01
001 007 100050 20 XX	100X50 mm KABLO KANALI (SİDEM) İ.KAPAKLI	20	m	800,00
001 007 120060 20 XX	120X60 mm KABLO KANALI (SİDEM) İ.KAPAKLI	16	m	1.050,00
001 007 120070 20 XX	120X70 mm KABLO KANALI (SİDEM)	16	m	1.350,00
001 007 170070 20 XX	170X70 mm KABLO KANALI (SİDEM)	12	m	1.700,00

SİDEM SERİSİ RENKLİ KABLO KANALLARI (YAPIŞKANLI)



001 155 010008 20 XX	10X8 mm KABLO KANALI (SİDEM) YAPIŞKANLI	330	m	144,44
001 155 012012 20 XX	12X12 mm KABLO KANALI (SİDEM) YAPIŞKANLI	250	m	144,44
001 155 015010 20 XX	15X10 mm KABLO KANALI (SİDEM) YAPIŞKANLI	250	m	144,44
001 155 016016 20 XX	16X16 mm KABLO KANALI (SİDEM) YAPIŞKANLI	240	m	177,78
001 155 020010 20 XX	20X10 mm KABLO KANALI (SİDEM) YAPIŞKANLI	180	m	144,44
001 155 025016 20 XX	25X16 mm KABLO KANALI (SİDEM) YAPIŞKANLI	150	m	222,22
001 155 025025 20 XX	25X25 mm KABLO KANALI (SİDEM) YAPIŞKANLI	100	m	259,26
001 155 930010 20 XX	30X10 mm KABLO KANALI (SİDEM) YAPIŞKANLI	140	m	203,70
001 155 930016 20 XX	30X16 mm KABLO KANALI (SİDEM) YAPIŞKANLI	140	m	259,26
001 155 030025 20 XX	30X25 mm KABLO KANALI (SİDEM) YAPIŞKANLI	80	m	296,30
001 155 040016 20 XX	40X16 mm KABLO KANALI (SİDEM) YAPIŞKANLI	100	m	300,00
001 155 040025 20 XX	40X25 mm KABLO KANALI (SİDEM) YAPIŞKANLI	80	m	370,37
001 155 040040 20 XX	40X40 mm KABLO KANALI (SİDEM) YAPIŞKANLI	50	m	407,41
001 155 960025 20 XX	60X25 mm KABLO KANALI (SİDEM) YAPIŞKANLI	40	m	592,59
001 155 060040 20 XX	60X40 mm KABLO KANALI (SİDEM) YAPIŞKANLI	40	m	611,11

SİDEM SERİSİ SÜPÜRGELİKLER ve AKSESUARLARI

001 007 974020 20 XX	74X20 mm KABLO KANALI (SİDEM) BÖLMELİ	50	m	407,41
001 007 975022 20 XX	75X22 mm KABLO KANALI (SİDEM) BÖLMELİ	50	m	555,56

SİDEM SERİSİ BALIK SIRTİ ZEMİN KANALLARI ve AKSESUARLARI

001 007 050013 20 XX	50X13 mm KABLO KANALI (SİDEM)	60	m	296,30
001 007 060015 20 XX	60X15 mm KABLO KANALI (SİDEM)	40	m	333,33
001 031 060015 00 XX	60X15 mm L KÖŞE(SİDEM)	1	ad.	148,15
001 032 060015 00 XX	60X15 mm EK PARÇA (SİDEM)	1	ad.	92,59
001 033 060015 00 XX	60X15 mm SONLAMA KAPAĞI (SİDEM)	1	ad.	92,59
001 030 060015 00 XX	60X15 mm T KÖŞE (SİDEM)	1	ad.	166,67
001 007 075018 20 XX	75X18 mm KABLO KANALI (SİDEM)	30	m	481,48
001 007 090020 20 XX	90X20 mm KABLO KANALI (SİDEM)	20	m	740,74



SIYAH
BLACK
MUT-11

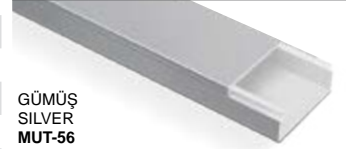

GÜMÜŞ
SILVER
MUT-56



ARMUT
PEAR
MUT-01



DAMARLI BEJ
RIBBED BEIGE
MUT-51

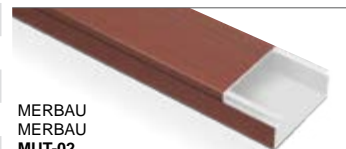

MERBAU
MERBAU
MUT-02



KIZIL KAHVE
SCARLET BROWN
MUT-52



KOYU CEVİZ
DARK WALNUT
MUT-03



DAMARLI KAHVE
RIBBED BROWN
MUT-53



AÇIK KAYIN
LIGHT BEECH
MUT-04



DAMARLI AÇIK BEJ
RIBBED LIGHT BEIGE
MUT-54



MAUN
MAHOGANY
MUT-05



DAMARLI KIZIL
RIBBED SCARLED
MUT-55

Ürün Kodu	Ürün Adı	Amb. (Kutu)	Amb. Birimi	Fiyat (₺)
SİDEM SERİSİ BALIK SIRTI ZEMİN KANALLARI (YAPIŞKANLI)				
001 155 050013 20 XX	50X13 mm KABLO KANALI (SİDEM) YAPIŞKANLI	60	m	444,44
001 155 060015 20 XX	60X15 mm KABLO KANALI (SİDEM) YAPIŞKANLI	40	m	462,96
001 155 075018 20 XX	75X18 mm KABLO KANALI (SİDEM) YAPIŞKANLI	30	m	518,52
12x12 KANAL AKSESUARLARI - SİDEM SERİSİ				
₺				
001 028 012012 00 XX	12X12 mm (SİDEM) İÇ KÖŞE	1	ad.	78,63
001 029 012012 00 XX	12X12 mm (SİDEM) DIŞ KÖŞE	1	ad.	78,63
001 030 012012 00 XX	12X12 mm (SİDEM) T KÖŞE	1	ad.	77,64
001 031 012012 00 XX	12X12 mm (SİDEM) 90 L KÖŞE	1	ad.	77,64
001 033 012012 00 XX	12X12 mm (SİDEM) UÇ TAPA	1	ad.	55,12
001 032 012012 00 XX	12X12 mm (SİDEM) EK PARÇASI	1	ad.	55,12
15x10 KANAL AKSESUARLARI - SİDEM SERİSİ				
₺				
001 028 015010 00 XX	15X10 mm (SİDEM) İÇ KÖŞE	1	ad.	50,74
001 029 015010 00 XX	15X10 mm (SİDEM) DIŞ KÖŞE	1	ad.	50,74
001 030 015010 00 XX	15X10 mm (SİDEM) T KÖŞE	1	ad.	80,03
001 031 015010 00 XX	15X10 mm (SİDEM) 90 L KÖŞE	1	ad.	80,03
001 033 015010 00 XX	15X10 mm (SİDEM) UÇ TAPA	1	ad.	46,85
001 032 015010 00 XX	15X10 mm (SİDEM) EK PARÇASI	1	ad.	46,85
16x16 KANAL AKSESUARLARI - SİDEM SERİSİ				
₺				
001 028 016016 00 XX	16x16 mm (SİDEM) İÇ KÖŞE	1	ad.	48,67
001 029 016016 00 XX	16x16 mm (SİDEM) DIŞ KÖŞE	1	ad.	48,67
001 030 016016 00 XX	16x16 mm (SİDEM) T KÖŞE	1	ad.	92,29
001 031 016016 00 XX	16x16 mm (SİDEM) 90 L KÖŞE	1	ad.	92,29
001 033 016016 00 XX	16x16 mm (SİDEM) UÇ TAPA	1	ad.	45,92
001 032 016016 00 XX	16x16 mm (SİDEM) EK PARÇASI	1	ad.	45,92
20x10 KANAL AKSESUARLARI - SİDEM SERİSİ				
₺				
001 028 020010 00 XX	20x10 mm (SİDEM) İÇ KÖŞE	1	ad.	72,69
001 029 020010 00 XX	20x10 mm (SİDEM) DIŞ KÖŞE	1	ad.	72,69
001 030 020010 00 XX	20x10 mm (SİDEM) T KÖŞE	1	ad.	76,02
001 031 020010 00 XX	20x10 mm (SİDEM) 90 L KÖŞE	1	ad.	76,02
001 033 020010 00 XX	20x10 mm (SİDEM) UÇ TAPA	1	ad.	51,53
001 032 020010 00 XX	20x10 mm (SİDEM) EK PARÇASI	1	ad.	51,53
TAVAN KÖŞE KANALI (23x23) AKSESUARLARI -SİDEM SERİSİ				
₺				
001 041 023023 00 XX	23X23 mm T PARÇASI	1	ad.	213,79
001 042 023023 00 XX	23X23 mm 90 L KÖŞE	1	ad.	213,79
001 043 023023 00 XX	23X23 mm EK PARÇA	1	ad.	55,59
001 044 023023 00 XX	23X23 mm UÇ TAPA	1	ad.	55,59
25x16 KANAL AKSESUARLARI - SİDEM SERİSİ				
₺				
001 028 025016 00 XX	25X16 mm (SİDEM) İÇ KÖŞE	1	ad.	92,51
001 029 025016 00 XX	25X16 mm (SİDEM) DIŞ KÖŞE	1	ad.	92,51
001 030 025016 00 XX	25X16 mm (SİDEM) T KÖŞE	1	ad.	103,92
001 031 025016 00 XX	25X16 mm (SİDEM) 90 L KÖŞE	1	ad.	103,92
001 033 025016 00 XX	25X16 mm (SİDEM) UÇ TAPA	1	ad.	60,67
001 032 025016 00 XX	25X16 mm (SİDEM) EK PARÇA	1	ad.	60,67
001 034 017421 00 XX	25X16 mm (SİDEM) PMK (45X45)	1	ad.	929,78
25x25 KANAL AKSESUARLARI - SİDEM SERİSİ				
₺				
001 028 025025 00 XX	25x25 mm (SİDEM) İÇ KÖŞE	1	ad.	69,61
001 029 025025 00 XX	25x25 mm (SİDEM) DIŞ KÖŞE	1	ad.	69,61
001 030 025025 00 XX	25x25 mm (SİDEM) T PARÇASI	1	ad.	97,53
001 031 025025 00 XX	25x25 mm (SİDEM) 90 L KÖŞE	1	ad.	97,53
001 033 025025 00 XX	25x25 mm (SİDEM) UÇ TAPA	1	ad.	50,47
001 032 025025 00 XX	25x25 mm (SİDEM) EK PARÇA	1	ad.	50,47
001 034 017421 00 XX	25x25 mm (SİDEM) PMK (45X45)	1	ad.	929,78

Ürün Kodu	Ürün Adı	Amb. (Kutu)	Amb. Birimi	Fiyat (₺)
30x10 KANAL AKSESUARLARI - SİDEM SERİSİ				CE
001 028 030010 00 XX	30X10 mm (SİDEM) İÇ KÖŞE	1	ad.	109,50
001 029 030010 00 XX	30X10 mm (SİDEM) DIŞ KÖŞE	1	ad.	109,50
001 030 030010 00 XX	30X10 mm (SİDEM) T PARÇASI	1	ad.	117,20
001 031 030010 00 XX	30X10 mm (SİDEM) 90 L KÖŞE	1	ad.	117,20
001 033 030010 00 XX	30X10 mm (SİDEM) UÇ TAPA	1	ad.	54,40
001 032 030010 00 XX	30X10 mm (SİDEM) EK PARÇA	1	ad.	54,40
30x16 KANAL AKSESUARLARI - SİDEM SERİSİ				CE
001 028 030016 00 XX	30x16 mm (SİDEM) İÇ KÖŞE	1	ad.	108,01
001 029 030016 00 XX	30x16 mm (SİDEM) DIŞ KÖŞE	1	ad.	108,01
001 030 030016 00 XX	30x16 mm (SİDEM) T PARÇASI	1	ad.	145,32
001 031 030016 00 XX	30x16 mm (SİDEM) 90 L KÖŞE	1	ad.	145,32
001 033 030016 00 XX	30x16 mm (SİDEM) UÇ TAPA	1	ad.	61,14
001 032 030016 00 XX	30x16 mm (SİDEM) EK PARÇA	1	ad.	61,14
30x25 KANAL AKSESUARLARI - SİDEM SERİSİ				CE
001 028 030025 00 XX	30X25 mm (SİDEM) İÇ KÖŞE	1	ad.	114,41
001 029 030025 00 XX	30X25 mm (SİDEM) DIŞ KÖŞE	1	ad.	114,41
001 030 030025 00 XX	30X25 mm (SİDEM) T PARÇASI	1	ad.	147,10
001 031 030025 00 XX	30X25 mm (SİDEM) 90 L KÖŞE	1	ad.	147,10
001 033 030025 00 XX	30X25 mm (SİDEM) UÇ TAPA	1	ad.	64,16
001 032 030025 00 XX	30X25 mm (SİDEM) EK PARÇA	1	ad.	64,16
40x16 KANAL AKSESUARLARI - SİDEM SERİSİ				CE
001 028 040016 00 XX	40x16 mm (SİDEM) İÇ KÖŞE	1	ad.	116,31
001 029 040016 00 XX	40x16 mm (SİDEM) DIŞ KÖŞE	1	ad.	116,31
001 030 040016 00 XX	40x16 mm (SİDEM) T PARÇASI	1	ad.	155,06
001 031 040016 00 XX	40x16 mm (SİDEM) 90 L KÖŞE	1	ad.	155,06
001 033 040016 00 XX	40x16 mm (SİDEM) UÇ TAPA	1	ad.	78,33
001 032 040016 00 XX	40x16 mm (SİDEM) EK PARÇA	1	ad.	78,33
001 034 017421 00 XX	40X16 mm (SİDEM) PMK (45X45)	1	ad.	929,78
40x25 KANAL AKSESUARLARI - SİDEM SERİSİ				CE
001 028 040025 00 XX	40X25 mm (SİDEM) İÇ KÖŞE	1	ad.	134,72
001 029 040025 00 XX	40X25 mm (SİDEM) DIŞ KÖŞE	1	ad.	134,72
001 030 040025 00 XX	40X25 mm (SİDEM) T KÖŞE	1	ad.	168,27
001 031 040025 00 XX	40X25 mm (SİDEM) 90 L KÖŞE	1	ad.	168,27
001 033 040025 00 XX	40X25 mm (SİDEM) UÇ TAPA	1	ad.	89,96
001 032 040025 00 XX	40X25 mm (SİDEM) EK PARÇASI	1	ad.	89,96
001 034 017421 00 XX	40X25 mm (SİDEM) PMK (45X45)	1	ad.	929,78
40x40 KANAL AKSESUARLARI - SİDEM SERİSİ				CE
001 028 040040 00 XX	40x40 mm (SİDEM) İÇ KÖŞE	1	ad.	142,38
001 029 040040 00 XX	40x40 mm (SİDEM) DIŞ KÖŞE	1	ad.	142,38
001 030 040040 00 XX	40x40 mm (SİDEM) T KÖŞE	1	ad.	149,39
001 031 040040 00 XX	40x40 mm (SİDEM) 90 L KÖŞE	1	ad.	149,38
001 033 040040 00 XX	40x40 mm (SİDEM) UÇ TAPA	1	ad.	108,44
001 032 040040 00 XX	40x40 mm (SİDEM) EK PARÇASI	1	ad.	108,44
001 034 017421 00 XX	40X40 mm (SİDEM) PMK (45X45)	1	ad.	929,78
60x25 KANAL AKSESUARLARI - SİDEM SERİSİ				CE
001 028 060025 00 XX	60x25 mm (SİDEM) İÇ KÖŞE	1	ad.	149,80
001 029 060025 00 XX	60x25 mm (SİDEM) DIŞ KÖŞE	1	ad.	149,80
001 030 060025 00 XX	60x25 mm (SİDEM) T KÖŞE	1	ad.	161,32
001 031 060025 00 XX	60x25 mm (SİDEM) 90 L KÖŞE	1	ad.	161,32
001 033 060025 00 XX	60x25 mm (SİDEM) UÇ TAPA	1	ad.	109,09
001 032 060025 00 XX	60x25 mm (SİDEM) EK PARÇASI	1	ad.	109,09



L KÖŞE



EK PARÇA



UÇ TAPA





İÇ KÖŞE



DIŞ KÖŞE



T KÖŞE



L KÖŞE



EK PARÇA



UÇ TAPA

Ürün Kodu	Ürün Adı	Amb. (Kutu)	Amb. Birimi	Fiyat (₺)
60x40 KANAL AKSESUARLARI - SİDEM SERİSİ				₺
001 028 060040 00 XX	60x40 mm (SİDEM) İÇ KÖŞE	1	ad.	154,88
001 029 060040 00 XX	60x40 mm (SİDEM) DIŞ KÖŞE	1	ad.	154,88
001 030 060040 00 XX	60x40 mm (SİDEM) T KÖŞE	1	ad.	162,43
001 031 060040 00 XX	60x40 mm (SİDEM) 90 L KÖŞE	1	ad.	162,43
001 033 060040 00 XX	60x40 mm (SİDEM) UÇ TAPA	1	ad.	113,04
001 032 060040 00 XX	60x40 mm (SİDEM) EK PARÇA	1	ad.	113,04
60x60 KANAL AKSESUARLARI - SİDEM SERİSİ				₺
001 028 060060 00 XX	60x60 mm (SİDEM) İÇ KÖŞE	1	ad.	192,46
001 029 060060 00 XX	60x60 mm (SİDEM) DIŞ KÖŞE	1	ad.	192,46
001 030 060060 00 XX	60x60 mm (SİDEM) T PARÇASI	1	ad.	221,55
001 031 060060 00 XX	60x60 mm (SİDEM) 90 L KÖŞE	1	ad.	221,55
001 033 060060 00 XX	60x60 mm (SİDEM) UÇ TAPA	1	ad.	132,03
001 032 060060 00 XX	60x60 mm (SİDEM) EK PARÇA	1	ad.	132,03
74x20 KANAL AKSESUARLARI - SİDEM SERİSİ				₺
001 028 074020 00 XX	74x20 mm (SİDEM) İÇ KÖŞE	1	ad.	160,35
001 029 074020 00 XX	74x20 mm (SİDEM) DIŞ KÖŞE	1	ad.	160,35
001 030 074020 00 XX	74x20 mm (SİDEM) T PARÇASI	1	ad.	167,24
001 031 074020 00 XX	74x20 mm (SİDEM) 90 L KÖŞE	1	ad.	167,24
001 032 074020 00 XX	74x20 mm (SİDEM) UÇ TAPA	1	ad.	151,85
001 033 074020 00 XX	74x20 mm (SİDEM) EK PARÇA	1	ad.	151,85
001 036 017420 00 XX	74x20 mm (SİDEM) PRİZ MONTAJ KASASI	1	ad.	1.641,98
75x22 KANAL AKSESUARLARI - SİDEM SERİSİ				₺
001 028 075022 00 XX	75x22 mm (SİDEM) İÇ KÖŞE	1	ad.	147,79
001 029 075022 00 XX	75x22 mm (SİDEM) DIŞ KÖŞE	1	ad.	147,79
001 033 075022 01 XX	75x22 mm (SİDEM) SAĞ SONLAMA	1	ad.	202,47
001 033 075022 02 XX	75x22 mm (SİDEM) SOL SONLAMA	1	ad.	202,47
001 032 075022 00 XX	75x22 mm (SİDEM) EK PARÇASI	1	ad.	134,09
80x40 KANAL AKSESUARLARI - SİDEM SERİSİ				₺
001 028 080040 00 XX	80x40 mm (SİDEM) İÇ KÖŞE	1	ad.	204,42
001 029 080040 00 XX	80x40 mm (SİDEM) DIŞ KÖŞE	1	ad.	204,42
001 030 080040 00 XX	80x40 mm (SİDEM) T PARÇASI	1	ad.	223,57
001 031 080040 00 XX	80x40 mm (SİDEM) 90 L KÖŞE	1	ad.	223,57
001 033 080040 00 XX	80x40 mm (SİDEM) UÇ TAPA	1	ad.	174,23
001 032 080040 00 XX	80x40 mm (SİDEM) EK PARÇA	1	ad.	174,23
80x60 KANAL AKSESUARLARI - SİDEM SERİSİ				₺
001 028 080060 00 XX	80x60 mm (SİDEM) İÇ KÖŞE	1	ad.	266,21
001 029 080060 00 XX	80x60 mm (SİDEM) DIŞ KÖŞE	1	ad.	266,21
001 030 080060 00 XX	80x60 mm (SİDEM) T PARÇASI	1	ad.	232,86
001 031 080060 00 XX	80x60 mm (SİDEM) 90 L KÖŞE	1	ad.	232,86
001 033 080060 00 XX	80x60 mm (SİDEM) UÇ TAPA	1	ad.	167,27
001 032 080060 00 XX	80x60 mm (SİDEM) EK PARÇA	1	ad.	167,27
100x37 KANAL AKSESUARLARI - SİDEM SERİSİ				₺
001 028 100037 00 XX	100x37 mm (SİDEM) İÇ KÖŞE (SABİT)	1	ad.	328,40
001 029 100037 00 XX	100x37 mm (SİDEM) DIŞ KÖŞE (SABİT)	1	ad.	328,40
001 028 100037 01 XX	100x37 mm (SİDEM) İÇ KÖŞE (HAREKETLİ)	1	ad.	328,40
001 029 100037 01 XX	100x37 mm (SİDEM) DIŞ KÖŞE (HAREKETLİ)	1	ad.	328,40
001 030 100037 00 XX	100x37 mm (SİDEM) T PARÇASI	1	ad.	349,88
001 031 100037 00 XX	100x37 mm (SİDEM) 90 L KÖŞE	1	ad.	349,88
001 033 100037 00 XX	100x37 mm (SİDEM) UÇ TAPA	1	ad.	229,17
001 032 100037 00 XX	100x37 mm (SİDEM) EK PARÇA	1	ad.	229,17

Ürün Kodu	Ürün Adı	Amb. (Kutu)	Amb. Birimi	Fiyat (₺)
100x40 KANAL AKSESUARLARI - SİDEM SERİSİ				CE
001 028 100040 00 XX	100X40 mm (SİDEM) İÇ KÖŞE (SABİT)	1	ad.	342,43
001 029 100040 00 XX	100X40 mm (SİDEM) DIŞ KÖŞE (SABİT)	1	ad.	342,43
001 028 100040 01 XX	100X40 mm (SİDEM) İÇ KÖŞE (HAREKETLİ)	1	ad.	342,43
001 029 100040 01 XX	100X40 mm (SİDEM) DIŞ KÖŞE (HAREKETLİ)	1	ad.	342,43
001 030 100040 00 XX	100X40 mm (SİDEM) T PARÇASI	1	ad.	356,04
001 031 100040 00 XX	100X40 mm (SİDEM) 90 L KÖŞE	1	ad.	356,04
001 033 100040 00 XX	100X40 mm (SİDEM) UÇ TAPA	1	ad.	232,93
001 032 100040 00 XX	100X40 mm (SİDEM) EK PARÇA	1	ad.	232,93
100x48 KANAL AKSESUARLARI - SİDEM SERİSİ				CE
001 028 100048 00 XX	100X48 mm (SİDEM) İÇ KÖŞE (SABİT)	1	ad.	369,86
001 029 100048 00 XX	100X48 mm (SİDEM) DIŞ KÖŞE (SABİT)	1	ad.	369,86
001 028 100048 01 XX	100X48 mm (SİDEM) İÇ KÖŞE (HAREKETLİ)	1	ad.	369,86
001 029 100048 01 XX	100X48 mm (SİDEM) DIŞ KÖŞE (HAREKETLİ)	1	ad.	369,86
001 030 100048 00 XX	100X48 mm (SİDEM) T PARÇASI	1	ad.	382,63
001 031 100048 00 XX	100X48 mm (SİDEM) 90 L KÖŞE	1	ad.	382,63
001 033 100048 00 XX	100X48 mm (SİDEM) UÇ TAPA	1	ad.	247,58
001 032 100048 00 XX	100X48 mm (SİDEM) EK PARÇA	1	ad.	247,58
100x50 KANAL AKSESUARLARI - SİDEM SERİSİ				CE
001 028 100050 00 XX	100X50 mm (SİDEM) İÇ KÖŞE (SABİT)	1	ad.	324,45
001 029 100050 00 XX	100X50 mm (SİDEM) DIŞ KÖŞE (SABİT)	1	ad.	324,45
001 028 100050 01 XX	100X50 mm (SİDEM) İÇ KÖŞE (HAREKETLİ)	1	ad.	324,45
001 029 100050 01 XX	100X50 mm (SİDEM) DIŞ KÖŞE (HAREKETLİ)	1	ad.	324,45
001 030 100050 00 XX	100X50 mm (SİDEM) T PARÇASI	1	ad.	331,76
001 031 100050 00 XX	100X50 mm (SİDEM) 90 L KÖŞE	1	ad.	331,76
001 033 100050 00 XX	100X50 mm (SİDEM) UÇ TAPA	1	ad.	215,57
001 032 100050 00 XX	100X50 mm (SİDEM) EK PARÇA	1	ad.	215,57
100x60 KANAL AKSESUARLARI - SİDEM SERİSİ				CE
001 028 100060 00 XX	100X60 mm (SİDEM) İÇ KÖŞE (SABİT)	1	ad.	366,31
001 029 100060 00 XX	100X60 mm (SİDEM) DIŞ KÖŞE (SABİT)	1	ad.	366,31
001 028 100060 01 XX	100X60 mm (SİDEM) İÇ KÖŞE (HAREKETLİ)	1	ad.	366,31
001 029 100060 01 XX	100X60 mm (SİDEM) DIŞ KÖŞE (HAREKETLİ)	1	ad.	366,31
001 030 100060 00 XX	100X60 mm (SİDEM) T PARÇASI	1	ad.	398,97
001 031 100060 00 XX	100X60 mm (SİDEM) 90 L KÖŞE	1	ad.	398,97
001 033 100060 00 XX	100X60 mm (SİDEM) UÇ TAPA	1	ad.	236,28
001 032 100060 00 XX	100X60 mm (SİDEM) EK PARÇA	1	ad.	236,28
İÇTEN KAPAKLI 100x37/50 İÇİN PMS - SİDEM SERİSİ				CE
001 034 400001 00 XX	100X37/50 (SİDEM) 45X45 PMS TEKLİ	1	ad.	192,61
001 034 400002 00 XX	100X37/50 (SİDEM) 45X45 PMS İKİLİ	1	ad.	205,43
001 034 400003 00 XX	100X37/50 (SİDEM) 45X45 PMS ÜÇLÜ	1	ad.	215,79
001 034 400004 00 XX	100X37/50 (SİDEM) 45X45 PMS DÖRTLÜ	1	ad.	326,61
001 034 500001 00 XX	100X37/50 (SİDEM) 55X55 PMS TEKLİ	1	ad.	275,59
001 034 500002 00 XX	100X37/50 (SİDEM) 55X55 PMS İKİLİ	1	ad.	317,52
001 034 500003 00 XX	100X37/50 (SİDEM) 55X55 PMS ÜÇLÜ	1	ad.	343,90
DIŞTAN KAPAKLI 100'LÜK PMS 55x55 İÇİN - SİDEM SERİSİ				CE
001 034 000001 00 XX	100'LÜK 55X55 PMS TEKLİ SİDEM	1	ad.	401,66
001 034 000002 00 XX	100'LÜK 55X55 PMS İKİLİ SİDEM	1	ad.	490,53
001 034 000003 00 XX	100'LÜK 55X55 PMS ÜÇLÜ SİDEM	1	ad.	556,69
DIŞTAN KAPAKLI 100'LÜK PMS 45x45 İÇİN - SİDEM SERİSİ				CE
001 034 100001 00 XX	100'LÜK 45X45 PMS TEKLİ SİDEM	1	ad.	259,47
001 034 100002 00 XX	100'LÜK 45X45 PMS İKİLİ SİDEM	1	ad.	332,24
001 034 100003 00 XX	100'LÜK 45X45 PMS ÜÇLÜ SİDEM	1	ad.	473,06
001 034 100004 00 XX	100'LÜK 45X45 PMS DÖRTLÜ SİDEM	1	ad.	501,97



İÇ KÖŞE



DIŞ KÖŞE



T KÖŞE



L KÖŞE



*Kutusuz ürünlerde topraklama klemensi bulunmamaktadır.

Ürün Kodu	Ürün Adı	Kutu Adet	Koli Adet	Normal Fiyat (₺)	Kutusuz ve Klemensiz Fiyat (₺)
COMFORT W OTOMAT KUTULARI					
IP40					
001 057 200001 00 00	COMFORT MÜHÜRLÜ SİGORTA KUTUSU(S/Ü) 1'Lİ	20	120	48,15	-
001 057 200002 00 00	COMFORT MÜHÜRLÜ SİGORTA KUTUSU(S/Ü) 1-2'Lİ	20	80	53,70	-
001 057 200004 00 00	COMFORT MÜHÜRLÜ SİGORTA KUTUSU(S/Ü) 2-4'Lİ	10	60	77,78	-
001 057 100006 00 00	COMFORT SİGORTA KUTUSU (S/Ü) 6'Lİ	1	20	407,41	334,08
001 057 100009 00 00	COMFORT SİGORTA KUTUSU (S/Ü) 9'LU	1	20	481,48	394,81
001 057 100012 00 00	COMFORT SİGORTA KUTUSU (S/Ü) 12'Lİ	1	10	592,59	485,92
001 057 100018 00 00	COMFORT SİGORTA KUTUSU (S/Ü) 18'Lİ	1	10	851,85	698,52
001 057 100024 00 00	COMFORT SİGORTA KUTUSU (S/Ü) 24'LÜ	1	5	1.037,04	819,26
001 057 100036 00 00	COMFORT SİGORTA KUTUSU (S/Ü) 36'Lİ	1	5	1.296,30	1.011,11
001 057 000006 00 00	COMFORT SİGORTA KUTUSU (S/A) 6'Lİ	1	20	407,41	334,08
001 057 000009 00 00	COMFORT SİGORTA KUTUSU (S/A) 9'LU	1	20	481,48	394,81
001 057 000012 00 00	COMFORT SİGORTA KUTUSU (S/A) 12'Lİ	1	10	592,59	485,92
001 057 000018 00 00	COMFORT SİGORTA KUTUSU (S/A) 18'Lİ	1	10	851,85	698,52
001 057 000024 00 00	COMFORT SİGORTA KUTUSU (S/A) 24'LÜ	1	5	1.037,04	819,26
001 057 000036 00 00	COMFORT SİGORTA KUTUSU (S/A) 36'Lİ	1	5	1.296,30	1.011,11



Ürün Kodu	Ürün Adı	Kutu Adet	Koli Adet	Fiyat (₺)
COMFORT W OTOMAT KUTULARI - ALEV YAYMAYAN				
IP40				
001 057 210001 00 00	COMFORT MÜHÜRLÜ SİGORTA (ALEV YAYMAYAN)(S/Ü) 1'Lİ	20	120	114,81
001 057 210002 00 00	COMFORT MÜHÜRLÜ SİGORTA (ALEV YAYMAYAN)(S/Ü) 1-2'Lİ	20	80	135,19
001 057 210004 00 00	COMFORT MÜHÜRLÜ SİGORTA (ALEV YAYMAYAN)(S/Ü) 2-4'LÜ	10	60	164,81
001 057 110006 00 00	COMFORT SİGORTA KUTUSU(S/Ü)(ALEV YAYMAYAN) 6'Lİ	1	20	703,70
001 057 110009 00 00	COMFORT SİGORTA KUTUSU(S/Ü)(ALEV YAYMAYAN) 9'LU	1	20	888,89
001 057 110012 00 00	COMFORT SİGORTA KUTUSU(S/Ü)(ALEV YAYMAYAN) 12'Lİ	1	10	1.148,15
001 057 110018 00 00	COMFORT SİGORTA KUTUSU(S/Ü)(ALEV YAYMAYAN) 18'Lİ	1	10	1.629,63
001 057 110024 00 00	COMFORT SİGORTA KUTUSU(S/Ü)(ALEV YAYMAYAN) 24'LÜ	1	5	1.796,30
001 057 110036 00 00	COMFORT SİGORTA KUTUSU(S/Ü)(ALEV YAYMAYAN) 36'Lİ	1	5	2.407,41
001 057 010006 00 00	COMFORT SİGORTA KUTUSU(S/A) ALEV YAYMAYAN 6'Lİ	1	20	703,70
001 057 010009 00 00	COMFORT SİGORTA KUTUSU(S/A) ALEV YAYMAYAN 9'LU	1	20	888,89
001 057 010012 00 00	COMFORT SİGORTA KUTUSU(S/A) ALEV YAYMAYAN 12'Lİ	1	10	1.148,15
001 057 010018 00 00	COMFORT SİGORTA KUTUSU(S/A) ALEV YAYMAYAN 18'Lİ	1	10	1.629,63
001 057 010024 00 00	COMFORT SİGORTA KUTUSU(S/A) ALEV YAYMAYAN 24'LÜ	1	5	1.796,30
001 057 010036 00 00	COMFORT SİGORTA KUTUSU(S/A) ALEV YAYMAYAN 36'Lİ	1	5	2.407,41



Ürün Kodu	Ürün Adı	Kutu Adet	Koli Adet	Fiyat (₺)
COMFORT W OTOMAT KUTULARI - HALOJEN FREE - ALEV YAYAN				
IP40				
001 057 220001 00 00	COMFORT MÜHÜRLÜ SİGORTA KUTUSU HALOJEN FREE (ALEV YAYAN)(S/Ü)1'Lİ	20	120	62,96
001 057 220002 00 00	COMFORT MÜHÜRLÜ SİGORTA KUTUSU HALOJEN FREE (ALEV YAYAN)(S/Ü)1-2'Lİ	20	80	81,48
001 057 220004 00 00	COMFORT MÜHÜRLÜ SİGORTA KUTUSU HALOJEN FREE (ALEV YAYAN)(S/Ü)2-4'Lİ	10	60	103,70
001 057 120006 00 00	COMFORT SİGORTA KUTUSU HALOJEN FREE (ALEV YAYAN) (S/Ü) 6'Lİ	1	20	500,00
001 057 120009 00 00	COMFORT SİGORTA KUTUSU HALOJEN FREE (ALEV YAYAN) (S/Ü) 9'LU	1	20	592,59
001 057 120012 00 00	COMFORT SİGORTA KUTUSU HALOJEN FREE (ALEV YAYAN) (S/Ü) 12'Lİ	1	10	796,30
001 057 120018 00 00	COMFORT SİGORTA KUTUSU HALOJEN FREE (ALEV YAYAN) (S/Ü) 18'Lİ	1	10	1.111,11
001 057 120024 00 00	COMFORT SİGORTA KUTUSU HALOJEN FREE (ALEV YAYAN) (S/Ü) 24'LÜ	1	5	1.462,96
001 057 120036 00 00	COMFORT SİGORTA KUTUSU HALOJEN FREE (ALEV YAYAN) (S/Ü) 36'Lİ	1	5	1.592,59
001 057 020006 00 00	COMFORT SİGORTA KUTUSU HALOJEN FREE (ALEV YAYAN) (S/A) 6'Lİ	1	20	500,00
001 057 020009 00 00	COMFORT SİGORTA KUTUSU HALOJEN FREE (ALEV YAYAN) (S/A) 9'LU	1	20	592,59
001 057 020012 00 00	COMFORT SİGORTA KUTUSU HALOJEN FREE (ALEV YAYAN) (S/A) 12'Lİ	1	10	796,30
001 057 020018 00 00	COMFORT SİGORTA KUTUSU HALOJEN FREE (ALEV YAYAN) (S/A) 18'Lİ	1	10	1.111,11
001 057 020024 00 00	COMFORT SİGORTA KUTUSU HALOJEN FREE (ALEV YAYAN) (S/A) 24'LÜ	1	5	1.462,96
001 057 020036 00 00	COMFORT SİGORTA KUTUSU HALOJEN FREE (ALEV YAYAN) (S/A) 36'Lİ	1	5	1.592,59



Ürün Kodu	Ürün Adı	Kutu Adet	Koli Adet	Fiyat (₺)
COMFORT W OTOMAT ZAYIF AKIM KUTULARI				IP40
001 057 101012 00 00	COMFORT ZAYIF AKIM KUTUSU (S/Ü)(225x270)	1	10	592,59
001 057 101020 00 00	COMFORT ZAYIF AKIM KUTUSU (S/Ü)(270x340)	1	5	1.000,00
001 057 101024 00 00	COMFORT 12'Lİ SİGORTA + ZAYIF AKIM KUTUSU (S/Ü)	1	5	1.074,07
001 057 101036 00 00	COMFORT 24'LÜ SİGORTA + ZAYIF AKIM KUTUSU (S/Ü)	1	5	1.351,85
001 057 001012 00 00	COMFORT ZAYIF AKIM KUTUSU (S/A)(205x250)	1	10	592,59
001 057 001020 00 00	COMFORT ZAYIF AKIM KUTUSU (S/A)(248x318)	1	5	1.000,00
001 057 001024 00 00	COMFORT 12'Lİ SİGORTA + ZAYIF AKIM KUTUSU (S/A)	1	5	1.074,07
001 057 001036 00 00	COMFORT 24'LÜ SİGORTA + ZAYIF AKIM KUTUSU (S/A)	1	5	1.351,85



Ürün Kodu	Ürün Adı	Kutu Adet	Koli Adet	Fiyat (₺)
COMFORT W OTOMAT ZAYIF AKIM KUTULARI - HALOJEN FREE - ALEV YAYAN				IP40
001 057 121012 00 00	COMFORT ZAYIF AKIM KUTUSU H.FREE (ALEV YAYAN) (S/Ü)(225x270)	1	10	759,26
001 057 121020 00 00	COMFORT ZAYIF AKIM KUTUSU H.FREE (ALEV YAYAN) (S/Ü)(270x340)	1	5	1.240,74
001 057 121024 00 00	COMFORT 12'Lİ SİGORTA + ZAYIF AKIM KUTUSU H.FREE (ALEV YAYAN) (S/Ü)	1	5	1.351,85
001 057 121036 00 00	COMFORT 24'LÜ SİGORTA + ZAYIF AKIM KUTUSU H.FREE (ALEV YAYAN) (S/Ü)	1	5	1.629,63
001 057 021012 00 00	COMFORT ZAYIF AKIM KUTUSU H.FREE (ALEV YAYAN) (S/A)(205x250)	1	10	759,26
001 057 021020 00 00	COMFORT ZAYIF AKIM KUTUSU H.FREE (ALEV YAYAN) (S/A)(248x318)	1	5	1.240,74
001 057 021024 00 00	COMFORT 12'Lİ SİGORTA + ZAYIF AKIM KUTUSU H.FREE (ALEV YAYAN) (S/A)	1	5	1.351,85
001 057 021036 00 00	COMFORT 24'LÜ SİGORTA + ZAYIF AKIM KUTUSU H.FREE (ALEV YAYAN) (S/A)	1	5	1.629,63

Ürün Kodu	Ürün Adı	Kutu Adet	Koli Adet	Fiyat (₺)
COMFORT W OTOMAT ZAYIF AKIM KUTULARI - ALEV YAYMAYAN				IP40
001 057 111012 00 00	COMFORT ZAYIF AKIM KUTUSU(A.YAYMAYAN)(S/Ü)(225x270)	1	10	1.018,52
001 057 111020 00 00	COMFORT ZAYIF AKIM KUTUSU(A.YAYMAYAN)(S/Ü)(270x340)	1	5	1.629,63
001 057 111024 00 00	COMFORT 12'Lİ SİGORTA + ZAYIF AKIM KUTUSU(A.YAYMAYAN)(S/Ü)	1	5	1.629,63
001 057 111036 00 00	COMFORT 24'LÜ SİGORTA + ZAYIF AKIM KUTUSU(A.YAYMAYAN)(S/Ü)	1	5	2.037,04
001 057 011012 00 00	COMFORT ZAYIF AKIM KUTUSU(A.YAYMAYAN)(S/A)(205x250)	1	10	1.018,52
001 057 011020 00 00	COMFORT ZAYIF AKIM KUTUSU(A.YAYMAYAN)(S/A)(248x318)	1	5	1.629,63
001 057 011024 00 00	COMFORT 12'Lİ SİGORTA + ZAYIF AKIM KUTUSU(A.YAYMAYAN)(S/A)	1	5	1.629,63
001 057 011036 00 00	COMFORT 24'LÜ SİGORTA + ZAYIF AKIM KUTUSU(A.YAYMAYAN)(S/A)	1	5	2.037,04



Sıva altı serisinde **betopan**, **alçıpan** duvarlara montaj yapılabileme özelliği.











Ürün Kodu	Ürün Adı	Kutu Adet	Koli Adet	Fiyat (₺)
COMFORT W OTOMAT KUTUSU AKSESUARLARI				
001 057 990001 00 00	SIVA ALTI COMFORT ALÇIPAN MONTAJ SETİ	1		62,96
001 057 990002 00 00	COMFORT SU TERAZİSİ	1		111,11
000 700 000574 00 00	RAY YÜKSELTME PARÇASI (UZUN/KISA)	1		11,11
001 057 001236 00 00	COMFORT ZAYIF AKIM ÖRTME PARÇASI	50		62,96

Ürün Kodu	Ürün Adı	Kutu Adet	Koli Adet	Fiyat (₺)
W OTOMAT ÖRTME PARÇASI				
001 026 000002 00 00	W OTOMAT ÖRTME PARÇASI 12'Lİ	50	400	37,04





Ürün Kodu	Ürün Adı	Kutu Adet	Koli Adet	Kutu Fiyat (₺)
MEKSBOX W OTOMAT KUTULARI				IP30
001 027 200001 00 00	MÜHÜRLÜ W OTOMAT KUTUSU (S/Ü) 1'Lİ	20	160	44,44
001 027 200002 00 00	MÜHÜRLÜ W OTOMAT KUTUSU (S/Ü) 2'Lİ	20	80	51,85
001 027 200004 00 00	MÜHÜRLÜ W OTOMAT KUTUSU (S/Ü) 4'LÜ	10	80	74,07
001 027 100002 00 00	W OTOMAT KUTUSU (S/Ü) MEKSBOX 2'Lİ	1	30	370,37
001 027 000002 00 00	W OTOMAT KUTUSU (S/A) MEKSBOX 2'Lİ	1	30	370,37
001 027 100004 00 00	W OTOMAT KUTUSU (S/Ü) MEKSBOX 4'LÜ	1	20	377,78
001 027 000004 00 00	W OTOMAT KUTUSU (S/A) MEKSBOX 4'LÜ	1	20	377,78
001 027 100006 00 00	W OTOMAT KUTUSU (S/Ü) MEKSBOX 6'Lİ	1	20	388,89
001 027 000006 00 00	W OTOMAT KUTUSU (S/A) MEKSBOX 6'Lİ	1	20	388,89
001 027 100009 00 00	W OTOMAT KUTUSU (S/Ü) MEKSBOX 9'LU	1	20	481,48
001 027 000009 00 00	W OTOMAT KUTUSU (S/A) MEKSBOX 9'LU	1	20	481,48
001 027 100012 00 00	W OTOMAT KUTUSU (S/Ü) MEKSBOX 12'Lİ	1	10	577,78
001 027 000012 00 00	W OTOMAT KUTUSU (S/A) MEKSBOX 12'Lİ	1	10	577,78
001 027 100016 00 00	W OTOMAT KUTUSU (S/Ü) MEKSBOX 16'Lİ	1	10	833,33
001 027 000016 00 00	W OTOMAT KUTUSU (S/A) MEKSBOX 16'Lİ	1	10	833,33
001 027 100024 00 00	W OTOMAT KUTUSU (S/Ü) MEKSBOX 24'LÜ	1	5	1.018,52
001 027 000024 00 00	W OTOMAT KUTUSU (S/A) MEKSBOX 24'LÜ	1	5	1.018,52
001 027 100036 00 00	W OTOMAT KUTUSU (S/Ü) MEKSBOX 36'Lİ	1	5	1.277,78
001 027 000036 00 00	W OTOMAT KUTUSU (S/A) MEKSBOX 36'Lİ	1	5	1.277,78
MEKSBOX W OTOMAT KUTULARI - ALEV YAYMAYAN				IP30
001 027 210001 00 00	MÜHÜRLÜ W OTOMAT KUTUSU ALEV YAYMAYAN (S/Ü) 1'Lİ	20	160	103,70
001 027 210002 00 00	MÜHÜRLÜ W OTOMAT KUTUSU ALEV YAYMAYAN (S/Ü) 2'Lİ	20	80	122,22
001 027 210004 00 00	MÜHÜRLÜ W OTOMAT KUTUSU ALEV YAYMAYAN (S/Ü) 4'LÜ	10	80	148,15
001 027 110002 00 00	W OTOMAT KUTUSU (S/Ü) ALEV YAYMAYAN 2'Lİ	1	30	629,63
001 027 010002 00 00	W OTOMAT KUTUSU (S/A) ALEV YAYMAYAN 2'Lİ	1	30	629,63
001 027 110004 00 00	W OTOMAT KUTUSU (S/Ü) ALEV YAYMAYAN 4'LÜ	1	20	648,15
001 027 010004 00 00	W OTOMAT KUTUSU (S/A) ALEV YAYMAYAN 4'LÜ	1	20	648,15
001 027 110006 00 00	W OTOMAT KUTUSU (S/Ü) ALEV YAYMAYAN 6'Lİ	1	20	685,19
001 027 010006 00 00	W OTOMAT KUTUSU (S/A) ALEV YAYMAYAN 6'Lİ	1	20	685,19
001 027 110009 00 00	W OTOMAT KUTUSU (S/Ü) ALEV YAYMAYAN 9'LU	1	20	870,37
001 027 010009 00 00	W OTOMAT KUTUSU (S/A) ALEV YAYMAYAN 9'LU	1	20	870,37
001 027 110012 00 00	W OTOMAT KUTUSU (S/Ü) ALEV YAYMAYAN 12'Lİ	1	10	1.129,63
001 027 010012 00 00	W OTOMAT KUTUSU (S/A) ALEV YAYMAYAN 12'Lİ	1	10	1.129,63
001 027 110016 00 00	W OTOMAT KUTUSU (S/Ü) ALEV YAYMAYAN 16'Lİ	1	10	1.333,33
001 027 010016 00 00	W OTOMAT KUTUSU (S/A) ALEV YAYMAYAN 16'Lİ	1	10	1.333,33
001 027 110024 00 00	W OTOMAT KUTUSU (S/Ü) ALEV YAYMAYAN 24'LÜ	1	5	1.777,78
001 027 010024 00 00	W OTOMAT KUTUSU (S/A) ALEV YAYMAYAN 24'LÜ	1	5	1.777,78
001 027 110036 00 00	W OTOMAT KUTUSU (S/Ü) ALEV YAYMAYAN 36'Lİ	1	5	2.314,81
001 027 010036 00 00	W OTOMAT KUTUSU (S/A) ALEV YAYMAYAN 36'Lİ	1	5	2.314,81

Ürün Kodu	Ürün Adı	Ort. İç Çap	Ort. Dış Çap	Kutu Mt.	Koli Adet	Fiyat (₺)
HAFİF SERİ PVC SİRALLER - ALEV YAYMAYAN (320N) 						
001 020 010016 00 17	Ø16 ALEV YAYMAYAN SİRAL (HAFİF SERİ)	11,4	15,85	100 mt.	500	16,83
001 020 010020 00 17	Ø20 ALEV YAYMAYAN SİRAL (HAFİF SERİ)	14,5	19,85	100 mt.	500	22,20
001 020 010025 00 17	Ø25 ALEV YAYMAYAN SİRAL (HAFİF SERİ)	18,7	24,8	50 mt.	250	31,50
001 020 010032 00 17	Ø32 ALEV YAYMAYAN SİRAL (HAFİF SERİ)	24,9	31,8	50 mt.	250	39,11
AĞIR SERİ PVC SİRALLER -ALEV YAYMAYAN (750N) 						
001 020 000016 00 17	Ø16 ALEV YAYMAYAN SİRAL (AĞIR SERİ)	11,2	15,85	100 mt.	500	19,25
001 020 000020 00 17	Ø20 ALEV YAYMAYAN SİRAL (AĞIR SERİ)	14,4	19,85	100 mt.	500	24,45
001 020 000025 00 17	Ø25 ALEV YAYMAYAN SİRAL (AĞIR SERİ)	18,1	24,8	50 mt.	250	33,00
001 020 000032 00 17	Ø32 ALEV YAYMAYAN SİRAL (AĞIR SERİ)	24,7	31,8	50 mt.	250	40,06
HAFİF SERİ PVC TELLİ SİRALLER - ALEV YAYMAYAN (320N) 						
001 020 120016 00 17	Ø16 TELLİ ALEV YAYMAYAN (HAFİF SERİ)	11,4	15,85	100 mt.	500	20,45
001 020 120020 00 17	Ø20 TELLİ ALEV YAYMAYAN (HAFİF SERİ)	14,5	19,85	100 mt.	500	25,92
001 020 120025 00 17	Ø25 TELLİ ALEV YAYMAYAN (HAFİF SERİ)	18,7	24,8	50 mt.	250	35,17
001 020 120032 00 17	Ø32 TELLİ ALEV YAYMAYAN (HAFİF SERİ)	24,9	31,8	50 mt.	250	43,21
AĞIR SERİ PVC TELLİ SİRALLER - ALEV YAYMAYAN (750N) 						
001 020 100016 00 17	Ø16 TELLİ ALEV YAYMAYAN (AĞIR SERİ)	11,2	15,85	100 mt.	500	22,91
001 020 100020 00 17	Ø20 TELLİ ALEV YAYMAYAN (AĞIR SERİ)	14,4	19,85	100 mt.	500	28,30
001 020 100025 00 17	Ø25 TELLİ ALEV YAYMAYAN (AĞIR SERİ)	18,1	24,8	50 mt.	250	36,91
001 020 100032 00 17	Ø32 TELLİ ALEV YAYMAYAN (AĞIR SERİ)	24,7	31,8	50 mt.	250	44,14
HALOJEN FREE SİRALLER -ALEV YAYAN (320N) 						
001 020 140016 00 17	Ø16 HALOJEN FREE SİRAL (ALEV YAYAN)	11,2	15,7	100 mt.	500	12,43
001 020 140020 00 17	Ø20 HALOJEN FREE SİRAL (ALEV YAYAN)	14,4	19,85	100 mt.	500	15,00
001 020 140025 00 17	Ø25 HALOJEN FREE SİRAL (ALEV YAYAN)	19,1	24,7	50 mt.	250	21,91
001 020 140032 00 17	Ø32 HALOJEN FREE SİRAL (ALEV YAYAN)	24,85	31,6	50 mt.	250	26,68
001 020 140040 00 17	Ø40 HALOJEN FREE SİRAL (ALEV YAYAN)			25 mt.	125	47,14
001 020 140050 00 17	Ø50 HALOJEN FREE SİRAL (ALEV YAYAN)			25 mt.	125	56,70
HALOJEN FREE SİRALLER -ALEV YAYAN (750N) 						
001 020 740020 00 17	Ø20 HALOJEN FREE SİRAL (ALEV YAYAN)	14,4	19,85	100 mt.	500	32,70
001 020 740025 00 17	Ø25 HALOJEN FREE SİRAL (ALEV YAYAN)	18,7	24,7	50 mt.	250	44,85
001 020 740032 00 17	Ø32 HALOJEN FREE SİRAL (ALEV YAYAN)	24,2	31,6	50 mt.	250	62,13
HALOJEN FREE SİRALLER TELLİ - ALEV YAYAN (320N) 						
001 020 141016 00 17	Ø16 HALOJEN FREE SİRAL(ALEV YAYAN)(TELLİ)	11,2	15,7	100 mt.	500	14,46
001 020 141020 00 17	Ø20 HALOJEN FREE SİRAL(ALEV YAYAN)(TELLİ)	14,4	19,85	100 mt.	500	17,03
001 020 141025 00 17	Ø25 HALOJEN FREE SİRAL(ALEV YAYAN)(TELLİ)	19,1	24,7	50 mt.	250	23,94
001 020 141032 00 17	Ø32 HALOJEN FREE SİRAL(ALEV YAYAN)(TELLİ)	24,85	31,6	50 mt.	250	28,71
001 020 141040 00 17	Ø40 HALOJEN FREE SİRAL(ALEV YAYAN)(TELLİ)			25 mt.	125	48,90
HALOJEN FREE SİRALLER - ALEV YAYMAYAN (320N) 						
001 020 150016 00 17	Ø16 HALOJEN FREE SİRAL(ALEV YAYMAYAN)	11,2	15,7	100 mt.	500	18,81
001 020 150020 00 17	Ø20 HALOJEN FREE SİRAL(ALEV YAYMAYAN)	14,4	19,85	100 mt.	500	23,74
001 020 150025 00 17	Ø25 HALOJEN FREE SİRAL(ALEV YAYMAYAN)	19,1	24,7	50 mt.	250	34,43
001 020 150032 00 17	Ø32 HALOJEN FREE SİRAL(ALEV YAYMAYAN)	24,85	31,6	50 mt.	250	42,03
001 020 150040 00 17	Ø40 HALOJEN FREE SİRAL(ALEV YAYMAYAN)			25 mt.	125	74,30
001 020 150050 00 17	Ø50 HALOJEN FREE SİRAL(ALEV YAYMAYAN)			25 mt.	125	90,23
HALOJEN FREE SİRALLER - ALEV YAYMAYAN (750N) 						
001 020 750020 00 17	Ø20 HALOJEN FREE SİRAL (ALEV YAYMAYAN)	14,4	19,85	100 mt.	500	48,12
001 020 750025 00 17	Ø25 HALOJEN FREE SİRAL (ALEV YAYMAYAN)	18,7	24,7	50 mt.	250	67,77
001 020 750032 00 17	Ø32 HALOJEN FREE SİRAL (ALEV YAYMAYAN)	24,2	31,6	50 mt.	250	89,41
HALOJEN FREE SİRALLER TELLİ - ALEV YAYMAYAN (320N) 						
001 020 151016 00 17	Ø16 HALOJEN SİRAL(ALEV YAYMAYAN)(TELLİ)	11,2	15,7	100 mt.	500	22,76
001 020 151020 00 17	Ø20 HALOJEN SİRAL(ALEV YAYMAYAN)(TELLİ)	14,4	19,85	100 mt.	500	26,92
001 020 151025 00 17	Ø25 HALOJEN SİRAL(ALEV YAYMAYAN)(TELLİ)	19,1	24,7	50 mt.	250	36,93
001 020 151032 00 17	Ø32 HALOJEN SİRAL(ALEV YAYMAYAN)(TELLİ)	24,85	31,6	50 mt.	250	43,57
001 020 151040 00 17	Ø40 HALOJEN SİRAL(ALEV YAYMAYAN)(TELLİ)			25 mt.	125	73,92





Ürün Kodu	Ürün Adı	Ort. İç Çap	Ort. Dış Çap	Kutu m/Ad.	Koli Adet	Fiyat (₺)
-----------	----------	-------------	--------------	------------	-----------	-----------

MEKS SERİSİ PLASTİK SİRALLER - SİYAH

001 020 400012 00 11	Ø12 PLASTİK SİRALLER (SİYAH)	12,3	15,9	100 m	1000	10,12
001 020 400014 00 11	Ø14 PLASTİK SİRALLER (SİYAH)	15,25	18,75	100 m	1000	10,37
001 020 400016 00 11	Ø16 PLASTİK SİRALLER (SİYAH)	15,7	19	100 m	1000	10,37
001 020 400018 00 11	Ø18 PLASTİK SİRALLER (SİYAH)	19,6	24,03	100 m	500	15,20
001 020 400020 00 11	Ø20 PLASTİK SİRALLER (SİYAH)	19,6	24,03	100 m	500	15,20
001 020 400026 00 11	Ø26 PLASTİK SİRALLER (SİYAH)	26,15	30,75	50 m	250	22,65
001 020 400032 00 11	Ø32 PLASTİK SİRALLER (SİYAH)	29,1	34,3	50 m	250	26,29
001 020 400040 00 11	Ø40 PLASTİK SİRALLER (SİYAH)	36,2	42,2	25 m	125	41,45
001 020 400050 00 11	Ø50 PLASTİK SİRALLER (SİYAH)	48,5	54,5	25 m	125	49,39

MEKS SERİSİ PLASTİK SİRALLER - SİYAH - TELLİ

001 020 410014 00 11	Ø14 PLASTİK SİRALLER (SİYAH) TELLİ	15,25	18,75	100 m	1000	13,22
001 020 410016 00 11	Ø16 PLASTİK SİRALLER (SİYAH) TELLİ	15,7	19	100 m	1000	13,22
001 020 410018 00 11	Ø18 PLASTİK SİRALLER (SİYAH) TELLİ	19,6	24,03	100 m	500	17,37
001 020 410020 00 11	Ø20 PLASTİK SİRALLER (SİYAH) TELLİ	19,6	24,03	100 m	500	17,37
001 020 410026 00 11	Ø26 PLASTİK SİRALLER (SİYAH) TELLİ	26,15	30,75	50 m	250	24,96
001 020 410032 00 11	Ø32 PLASTİK SİRALLER (SİYAH) TELLİ	29,1	34,3	50 m	250	28,48
001 020 410040 00 11	Ø40 PLASTİK SİRALLER (SİYAH) TELLİ	36,2	42,2	25 m	125	43,71

Ürün Kodu	Ürün Adı	Ort. İç Çap	Ort. Dış Çap	Kutu m/Ad.	Koli Adet	Gri Fiyat (₺)	Beyaz Fiyat (₺)
-----------	----------	-------------	--------------	------------	-----------	---------------	-----------------

PLASTİK SİRALLER - GRİ/BEYAZ

001 020 400014 00 XX	Ø14 PLASTİK SİRAL (GRİ-BEYAZ)	15,25	18,75	100 m	1000	11,87	13,48
001 020 400016 00 XX	Ø16 PLASTİK SİRAL (GRİ-BEYAZ)	15,7	19	100 m	1000	13,48	13,48
001 020 400018 00 XX	Ø18 PLASTİK SİRAL (GRİ-BEYAZ)	19,6	24,03	100 m	500	17,70	22,64
001 020 400020 00 XX	Ø20 PLASTİK SİRAL (GRİ-BEYAZ)	19,6	24,03	100 m	500	17,70	22,64
001 020 400026 00 XX	Ø26 PLASTİK SİRAL (GRİ-BEYAZ)	26,15	30,75	50 m	250	26,41	30,17
001 020 400032 00 XX	Ø32 PLASTİK SİRAL (GRİ-BEYAZ)	29,1	34,3	50 m	250	30,59	34,93
001 020 400040 00 XX	Ø40 PLASTİK SİRAL (GRİ-BEYAZ)	36,2	42,2	25 m	125	48,46	55,41
001 020 400050 00 XX	Ø50 PLASTİK SİRAL (GRİ-BEYAZ)	48,5	54,5	25 m	125	56,63	74,74



Ürün Kodu	Ürün Adı	Ort. İç Çap	Ort. Dış Çap	Kutu m/Ad.	Koli Adet	Renkli Fiyat (₺)
-----------	----------	-------------	--------------	------------	-----------	------------------

PLASTİK SİRALLER - RENKLİ (KIRMIZI-TURUNCU-MAVİ)

001 020 400014 00 XX	Ø14 PLASTİK SİRAL (KIRMIZI-TURUNCU-MAVİ)	15,25	18,75	100 m	1000	11,87
001 020 400016 00 XX	Ø16 PLASTİK SİRAL (KIRMIZI-TURUNCU-MAVİ)	15,7	19	100 m	1000	11,90
001 020 400018 00 XX	Ø18 PLASTİK SİRAL (KIRMIZI-TURUNCU-MAVİ)	19,6	24,03	100 m	500	17,71
001 020 400020 00 XX	Ø20 PLASTİK SİRAL (KIRMIZI-TURUNCU-MAVİ)	19,6	24,03	100 m	500	17,64
001 020 400026 00 XX	Ø26 PLASTİK SİRAL (KIRMIZI-TURUNCU-MAVİ)	26,15	30,75	50 m	250	26,41
001 020 400032 00 XX	Ø32 PLASTİK SİRAL (KIRMIZI-TURUNCU-MAVİ)	29,1	34,3	50 m	250	30,59
001 020 400040 00 XX	Ø40 PLASTİK SİRAL (KIRMIZI-TURUNCU-MAVİ)	36,2	42,2	25 m	125	48,46
001 020 400050 00 XX	Ø50 PLASTİK SİRAL (KIRMIZI-TURUNCU-MAVİ)	48,5	54,5	25 m	125	56,63

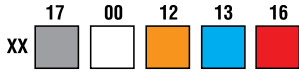
SİRAL EK MUFLARI - GRİ

001 020 990016 00 17	16 mm SİRAL EK MUFU (GRİ)				200 ad.	13,89
001 020 990020 00 17	20 mm SİRAL EK MUFU (GRİ)				200 ad.	16,67
001 020 990025 00 17	25 mm SİRAL EK MUFU (GRİ)				100 ad.	20,74
001 020 990032 00 17	32 mm SİRAL EK MUFU (GRİ)				200 ad.	27,78



Ürün Kodu	Ürün Adı	Ortalama İç Çap	Ortalama Dış Çap	Kutu Metre/Ad.	Fiyat (₺)
-----------	----------	-----------------	------------------	----------------	-----------





KORUGE BORULAR (250N)

096 045 150050	Ø50 KORUGE KANGAL BORU	43	50	100 m	83,03
096 045 150060	Ø63 KORUGE KANGAL BORU	54	63	100 m	103,78
096 045 150075	Ø75 KORUGE KANGAL BORU	64	75	100 m	124,54
096 045 150100	Ø100 KORUGE BOY BORU (6 m)	87	100	6 m	151,81
096 045 150115	Ø115 KORUGE BOY BORU (6 m)	100	115	6 m	166,06
096 045 150004	Ø50 MANŞON			1 ad.	35,58
096 045 150003	Ø75 MANŞON			1 ad.	45,99
096 045 150002	Ø100 MANŞON			1 ad.	53,38
096 045 150001	Ø115 MANŞON			1 ad.	65,24

RÖGAR KUTUSU

074 048 622020	20X20 RÖGAR KUTUSU TAKIM			1 ad.	300,93
074 048 623030	30X30 RÖGAR KUTUSU TAKIM			1 ad.	740,74
074 048 624040	40X40 RÖGAR KUTUSU TAKIM			1 ad.	1.527,78
074 048 625555	55X55 RÖGAR KUTUSU TAKIM			1 ad.	3.333,33



Ürün Kodu	Ürün Adı	Ort. İç Çap	Ort. Dış Çap	Kutu Metre	Koli Adet	Fiyat (₺)
EKO SERİSİ ÇELİK SİRALLER 						
001 054 150009 00 66	Ø9 EKO ÇELİK SİRALLER	9	12,1	50 m	200	32,34
001 054 150011 00 66	Ø11 EKO ÇELİK SİRALLER (3/8")	11	14,1	50 m	200	33,12
001 054 150014 00 66	Ø14 EKO ÇELİK SİRALLER (1/2")	14	17,1	50 m	200	39,86
001 054 150016 00 66	Ø16 EKO ÇELİK SİRALLER	16	19,1	50 m	200	43,81
001 054 150018 00 66	Ø18 EKO ÇELİK SİRALLER	18	21,1	50 m	200	47,99
001 054 150021 00 66	Ø21 EKO ÇELİK SİRALLER (3/4")	21	24,1	50 m	200	53,51
001 054 150026 00 66	Ø26 EKO ÇELİK SİRALLER (1")	26	29,1	25 m	100	73,08
001 054 150029 00 66	Ø29 EKO ÇELİK SİRALLER (1 1/4")	29	32,1	25 m	100	78,99
001 054 150032 00 66	Ø32 EKO ÇELİK SİRALLER	32	35,1	25 m	100	84,35
001 054 150037 00 66	Ø37 EKO ÇELİK SİRALLER (1 1/2")	37	41,1	25 m	100	110,84
001 054 150042 00 66	Ø42 EKO ÇELİK SİRALLER	42	45,1	25 m	100	129,14
001 054 150050 00 66	Ø50 EKO ÇELİK SİRALLER (2")	50	53,1	25 m	100	179,27
001 054 150063 00 66	Ø63 EKO ÇELİK SİRALLER	63	66,1	15 m	60	243,85
EKO SERİSİ ÇELİK SİRALLER - KILAVUZ TELLİ 						
001 054 221011 00 66	Ø11 EKO ÇELİK SİRAL (TELLİ)(3/8")	11	14,1	50 m	200	38,71
001 054 221014 00 66	Ø14 EKO ÇELİK SİRAL (TELLİ)(1/2")	14	17,1	50 m	200	46,98
001 054 221016 00 66	Ø16 EKO ÇELİK SİRAL (TELLİ)	16	19,1	50 m	200	49,74
001 054 221018 00 66	Ø18 EKO ÇELİK SİRAL (TELLİ)	18	21,1	50 m	200	57,90
001 054 221021 00 66	Ø21 EKO ÇELİK SİRAL (TELLİ) (3/4")	21	24,1	50 m	200	59,69
001 054 221026 00 66	Ø26 EKO ÇELİK SİRAL (TELLİ)(1")	26	29,1	25 m	100	80,54
001 054 221029 00 66	Ø29 EKO ÇELİK SİRAL (TELLİ)(1 1/4")	29	32,1	25 m	100	84,86
001 054 221032 00 66	Ø32 EKO ÇELİK SİRAL (TELLİ)	32	35,1	25 m	100	97,24
001 054 221037 00 66	Ø37 EKO ÇELİK SİRAL (TELLİ)(1 1/2")	37	41,1	25 m	100	117,90
001 054 221042 00 66	Ø42 EKO ÇELİK SİRAL (TELLİ)	42	45,1	25 m	100	136,03
001 054 221050 00 66	Ø50 EKO ÇELİK SİRAL (TELLİ) (2")	50	53,1	25 m	100	186,29
001 054 221063 00 66	Ø63 EKO ÇELİK SİRALLER	63	66,1	15 m	60	254,66
EKO SERİSİ İZOLELİ ÇELİK SİRALLER 						
001 054 160009 00 11	Ø9 EKO İZOLELİ ÇELİK SİRAL	9	13,2	50 m		40,69
001 054 160011 00 11	Ø11 EKO İZOLELİ ÇELİK SİRAL(3/8")	11	15,2	50 m		41,93
001 054 160014 00 11	Ø14 EKO İZOLELİ ÇELİK SİRAL(1/2")	14	18,4	50 m		49,87
001 054 160016 00 11	Ø16 EKO İZOLELİ ÇELİK SİRAL	16	20,4	50 m		52,89
001 054 160018 00 11	Ø18 EKO İZOLELİ ÇELİK SİRAL	18	22,4	50 m		61,08
001 054 160021 00 11	Ø21 EKO İZOLELİ ÇELİK SİRAL (3/4")	21	25,4	50 m		72,61
001 054 160026 00 11	Ø26 EKO İZOLELİ ÇELİK SİRAL(1")	26	30,4	25 m		89,08
001 054 160029 00 11	Ø29 EKO İZOLELİ ÇELİK SİRAL(1 1/4")	29	33,4	25 m		97,22
001 054 160032 00 11	Ø32 EKO İZOLELİ ÇELİK SİRAL	32	36,4	25 m		111,11
001 054 160037 00 11	Ø37 EKO İZOLELİ ÇELİK SİRAL (1 1/2")	37	42,4	25 m		138,52
001 054 160042 00 11	Ø42 EKO İZOLELİ ÇELİK SİRAL	42	46,4	25 m		167,96
001 054 160050 00 11	Ø50 EKO İZOLELİ ÇELİK SİRAL(2")	50	54,4	25 m		225,16
001 054 160063 00 11	Ø63 EKO İZOLELİ ÇELİK SİRAL	63	66,1	15 m		289,82
EKO SERİSİ İZOLELİ ÇELİK SİRALLER - KILAVUZ TELLİ 						
001 054 231011 00 11	Ø11 EKO İZOLELİ ÇELİK SİRAL (TELLİ)(3/8")	11	15,2	50 m		45,13
001 054 231014 00 11	Ø14 EKO İZOLELİ ÇELİK SİRAL (TELLİ)(1/2")	14	18,4	50 m		54,67
001 054 231016 00 11	Ø16 EKO İZOLELİ ÇELİK SİRAL (TELLİ)	16	20,4	50 m		58,29
001 054 231018 00 11	Ø18 EKO İZOLELİ ÇELİK SİRAL (TELLİ)	18	22,4	50 m		65,66
001 054 231021 00 11	Ø21 EKO İZOLELİ ÇELİK SİRAL (TELLİ) (3/4")	21	25,4	50 m		77,28
001 054 231026 00 11	Ø26 EKO İZOLELİ ÇELİK SİRAL (TELLİ)(1")	26	30,4	25 m		94,94
001 054 231029 00 11	Ø29 EKO İZOLELİ ÇELİK SİRAL (TELLİ)(1 1/4")	29	33,4	25 m		101,86
001 054 231032 00 11	Ø32 EKO İZOLELİ ÇELİK SİRAL (TELLİ)	32	36,4	25 m		119,77
001 054 231037 00 11	Ø37 EKO İZOLELİ ÇELİK SİRAL (TELLİ)(1 1/2")	37	42,4	25 m		147,43
001 054 231042 00 11	Ø42 EKO İZOLELİ ÇELİK SİRAL (TELLİ)	42	46,4	25 m		176,38
001 054 231050 00 11	Ø50 EKO İZOLELİ ÇELİK SİRAL (TELLİ) (2")	50	54,4	25 m		235,97
001 054 231063 00 11	Ø63 EKO İZOLELİ ÇELİK SİRAL	63	66,1	15 m		302,39



Ürün Kodu	Ürün Adı	Ort. İç Çap	Ort. Dış Çap	Kutu Metre/Ad.	Koli Adet	Fiyat (₺)
MEKS SERİSİ ÇELİK SİRALLER						
001 054 120009 00 66	Ø9 ÇELİK SİRALLER	9	12,1	50 m	200	34,59
001 054 120011 00 66	Ø11 ÇELİK SİRALLER(3/8")	11	14,1	50 m	200	36,00
001 054 120014 00 66	Ø14 ÇELİK SİRALLER(1/2")	14	17,1	50 m	200	43,33
001 054 120016 00 66	Ø16 ÇELİK SİRALLER	16	19,1	50 m	200	47,61
001 054 120018 00 66	Ø18 ÇELİK SİRALLER	18	21,1	50 m	200	52,16
001 054 120021 00 66	Ø21 ÇELİK SİRALLER (3/4")	21	24,1	50 m	200	57,94
001 054 120026 00 66	Ø26 ÇELİK SİRALLER(1")	26	29,1	25 m	100	75,89
001 054 120029 00 66	Ø29 ÇELİK SİRALLER(1 1/4")	29	32,1	25 m	100	81,40
001 054 120032 00 66	Ø32 ÇELİK SİRALLER	32	35,1	25 m	100	90,42
001 054 120037 00 66	Ø37 ÇELİK SİRALLER (1 1/2")	37	41,1	25 m	100	113,66
001 054 120042 00 66	Ø42 ÇELİK SİRALLER	42	45,1	25 m	100	135,41
001 054 120050 00 66	Ø50 ÇELİK SİRALLER(2")	50	53,1	25 m	100	191,16
001 054 120063 00 66	Ø63 ÇELİK SİRALLER	63	66,1	15 m	60	259,53



MEKS SERİSİ ÇELİK SİRALLER (KILAVUZ TELLİ)

001 054 121011 00 66	Ø11 ÇELİK SİRAL (TELLİ)(3/8")	11	14,1	50 m	200	40,24
001 054 121014 00 66	Ø14 ÇELİK SİRAL (TELLİ)(1/2")	14	17,1	50 m	200	48,85
001 054 121016 00 66	Ø16 ÇELİK SİRAL (TELLİ)	16	19,1	50 m	200	51,70
001 054 121018 00 66	Ø18 ÇELİK SİRAL (TELLİ)	18	21,1	50 m	200	62,94
001 054 121021 00 66	Ø21 ÇELİK SİRAL (TELLİ) (3/4")	21	24,1	50 m	200	64,77
001 054 121026 00 66	Ø26 ÇELİK SİRAL (TELLİ)(1")	26	29,1	25 m	100	86,18
001 054 121029 00 66	Ø29 ÇELİK SİRAL (TELLİ)(1 1/4")	29	32,1	25 m	100	91,02
001 054 121032 00 66	Ø32 ÇELİK SİRAL (TELLİ)	32	35,1	25 m	100	103,84
001 054 121037 00 66	Ø37 ÇELİK SİRAL (TELLİ)(1 1/2")	37	41,1	25 m	100	126,53
001 054 121042 00 66	Ø42 ÇELİK SİRAL (TELLİ)	42	45,1	25 m	100	147,85
001 054 121050 00 66	Ø50 ÇELİK SİRAL (TELLİ) (2")	50	53,1	25 m	100	201,84
001 054 121063 00 66	Ø63 ÇELİK SİRAL (TELLİ) (2")	63	66,1	15 m	60	274,15



MEKS SERİSİ İZOLELİ ÇELİK SİRALLER

001 054 130009 00 11	Ø9 İZOLELİ ÇELİK SİRAL	9	13,2	50 m		44,34
001 054 130011 00 11	Ø11 İZOLELİ ÇELİK SİRAL(3/8")	11	15,2	50 m		52,78
001 054 130014 00 11	Ø14 İZOLELİ ÇELİK SİRAL(1/2")	14	18,4	50 m		58,57
001 054 130016 00 11	Ø16 İZOLELİ ÇELİK SİRAL	16	20,4	50 m		67,65
001 054 130018 00 11	Ø18 İZOLELİ ÇELİK SİRAL	18	22,4	50 m		82,61
001 054 130026 00 11	Ø26 İZOLELİ ÇELİK SİRAL(1")	26	30,4	25 m		97,20
001 054 130029 00 11	Ø29 İZOLELİ ÇELİK SİRAL(1 1/4")	29	33,4	25 m		110,87
001 054 130032 00 11	Ø32 İZOLELİ ÇELİK SİRAL	32	36,4	25 m		125,93
001 054 130037 00 11	Ø37 İZOLELİ ÇELİK SİRAL (1 1/2")	37	42,4	25 m		152,87
001 054 130042 00 11	Ø42 İZOLELİ ÇELİK SİRAL	42	46,4	25 m		191,19
001 054 130050 00 11	Ø50 İZOLELİ ÇELİK SİRAL(2")	50	54,4	25 m		256,23
001 054 130063 00 11	Ø63 İZOLELİ ÇELİK SİRAL	63	67,2	15 m		329,32



MEKS SERİSİ İZOLELİ ÇELİK SİRALLER - KILAVUZ TELLİ

001 054 140011 00 11	Ø11 İZOLELİ ÇELİK SİRAL (TELLİ)(3/8")	11	15,2	50 m		49,98
001 054 140014 00 11	Ø14 İZOLELİ ÇELİK SİRAL (TELLİ)(1/2")	14	18,4	50 m		60,55
001 054 140016 00 11	Ø16 İZOLELİ ÇELİK SİRAL (TELLİ)	16	20,4	50 m		63,74
001 054 140018 00 11	Ø18 İZOLELİ ÇELİK SİRAL (TELLİ)	18	22,4	50 m		69,95
001 054 140026 00 11	Ø26 İZOLELİ ÇELİK SİRAL (TELLİ)(1")	26	30,4	25 m		103,66
001 054 140029 00 11	Ø29 İZOLELİ ÇELİK SİRAL (TELLİ)(1 1/4")	29	33,4	25 m		116,77
001 054 140032 00 11	Ø32 İZOLELİ ÇELİK SİRAL (TELLİ)	32	36,4	25 m		136,70
001 054 140037 00 11	Ø37 İZOLELİ ÇELİK SİRAL (TELLİ)(1 1/2")	37	42,4	25 m		161,55
001 054 140042 00 11	Ø42 İZOLELİ ÇELİK SİRAL (TELLİ)	42	46,4	25 m		202,81
001 054 140050 00 11	Ø50 İZOLELİ ÇELİK SİRAL (TELLİ) (2")	50	54,4	25 m		267,49
001 054 140063 00 11	Ø63 İZOLELİ ÇELİK SİRAL (TELLİ)	63	67,2	15 m		342,33



NİKEL KAPLI ÇELİK SİRAL RAKORU

012 097 030009	CLK-9 ÇELİK SİRAL RAKORU			1 ad.		6,71 €
012 097 030011	CLK-11 ÇELİK SİRAL RAKORU			1 ad.		7,87 €
012 097 030014	CLK-13,5 ÇELİK SİRAL RAKORU			1 ad.		12,50 €
012 097 030016	CLK-16 ÇELİK SİRAL RAKORU			1 ad.		13,66 €
012 097 030018	CLK-18 ÇELİK SİRAL RAKORU			1 ad.		20,00 €
012 097 030026	CLK-26 ÇELİK SİRAL RAKORU			1 ad.		33,33 €



Ürün Kodu	Ürün Adı	Kutu Metre	Koli Adet	Fiyat (₺)
-----------	----------	------------	-----------	-----------

PVC ALEV YAYMAYAN BOY BORULAR

001 045 120014 30 17	Ø14 PVC ALEV YAYMAYAN BOY BORU (3 m)	CC	102 m	25,93
001 045 120016 30 17	Ø16 PVC ALEV YAYMAYAN BOY BORU (3 m)	CC	102 m	31,48
001 045 120018 30 17	Ø18 PVC ALEV YAYMAYAN BOY BORU (3 m)	CC	102 m	33,33
001 045 120020 30 17	Ø20 PVC ALEV YAYMAYAN BOY BORU (3 m)	CC	102 m	45,37
001 045 120025 30 17	Ø25 PVC ALEV YAYMAYAN BOY BORU (3 m)	CC	51 m	61,11
001 045 120032 30 17	Ø32 PVC ALEV YAYMAYAN BOY BORU (3 m)	CC	30 m	101,85
001 045 120040 30 17	Ø40 PVC ALEV YAYMAYAN BOY BORU (3 m)	CC	30 m	190,74

PVC ALEV YAYMAYAN KENDİNDEN MUFLU BOY BORULAR

001 045 110014 30 17	Ø14 PVC ALEV YAYMAYAN KENDİNDEN MUFLU BOY BORU (3 m)	CC	102 m	29,63
001 045 110016 30 17	Ø16 PVC ALEV YAYMAYAN KENDİNDEN MUFLU BOY BORU (3 m)	CC	102 m	36,11
001 045 110018 30 17	Ø18 PVC ALEV YAYMAYAN KENDİNDEN MUFLU BOY BORU (3 m)	CC	102 m	38,15
001 045 110020 30 17	Ø20 PVC ALEV YAYMAYAN KENDİNDEN MUFLU BOY BORU (3 m)	CC	102 m	51,85
001 045 110025 30 17	Ø25 PVC ALEV YAYMAYAN KENDİNDEN MUFLU BOY BORU (3 m)	CC	51 m	70,37
001 045 110032 30 17	Ø32 PVC ALEV YAYMAYAN KENDİNDEN MUFLU BOY BORU (3 m)	CC	30 m	116,67
001 045 110040 30 17	Ø40 PVC ALEV YAYMAYAN KENDİNDEN MUFLU BOY BORU (3 m)	CC	30 m	218,52

DİRSEK VE MUFLAR - ALEV YAYMAYAN

001 051 010014 00 17	Ø14 DİRSEK ALEV YAYMAYAN	CC	100 ad.	700	14,81
001 051 010016 00 17	Ø16 DİRSEK ALEV YAYMAYAN	CC	100 ad.	600	15,56
001 051 010018 00 17	Ø18 DİRSEK ALEV YAYMAYAN	CC	100 ad.	400	16,85
001 051 010020 00 17	Ø20 DİRSEK ALEV YAYMAYAN	CC	100 ad.	300	18,52
001 051 010025 00 17	Ø25 DİRSEK ALEV YAYMAYAN	CC	50 ad.	150	36,11
001 051 010032 00 17	Ø32 DİRSEK ALEV YAYMAYAN	CC	50 ad.	100	55,56
001 051 030014 00 17	Ø14-16 MUF ALEV YAYMAYAN	CC	100 ad.	700	8,70
001 051 030018 00 17	Ø18-20 MUF ALEV YAYMAYAN	CC	100 ad.	500	9,26
001 051 030025 00 17	Ø25 MUF ALEV YAYMAYAN	CC	50 ad.	300	27,78
001 051 030032 00 17	Ø32 MUF ALEV YAYMAYAN	CC	50 ad.	200	36,11

GEÇMELİ TİP ANTİGRON BORU KROŞESİ

XX yerine Gri için 17, Beyaz için 00 rakamını yazınız.

001 048 010016 00 XX	Ø16 ANTİGRON BORU KROŞESİ (GEÇMELİ)		100 ad.	2000	3,70
001 048 010018 00 XX	Ø18 ANTİGRON BORU KROŞESİ (GEÇMELİ)		100 ad.	3000	7,22
001 048 010020 00 XX	Ø20 ANTİGRON BORU KROŞESİ (GEÇMELİ)		100 ad.	4500	7,41
001 048 010025 00 XX	Ø25 ANTİGRON BORU KROŞESİ (GEÇMELİ)		100 ad.	1000	7,78
001 048 010032 00 XX	Ø32 ANTİGRON BORU KROŞESİ (GEÇMELİ)		100 ad.	800	8,15
001 048 010040 00 XX	Ø40 ANTİGRON BORU KROŞESİ (GEÇMELİ)		50 ad.	750	15,93
001 048 020016 00 XX	Ø16 ANTİGRON BORU KROŞESİ (RAY TİPİ - GEÇMELİ)		100 ad.	2000	4,44
001 048 020020 00 XX	Ø20 ANTİGRON BORU KROŞESİ (RAY TİPİ - GEÇMELİ)		100 ad.	1500	7,78
001 048 020025 00 XX	Ø25 ANTİGRON BORU KROŞESİ (RAY TİPİ - GEÇMELİ)		100 ad.	1000	8,15
001 048 020032 00 XX	Ø32 ANTİGRON BORU KROŞESİ (RAY TİPİ - GEÇMELİ)		100 ad.	800	8,52
074 048 050016	Ø16 ANTİGRON BORU KROŞESİ KAPAKLI (GEÇMELİ)		100 ad.	4000	5,33
074 048 050017	Ø20 ANTİGRON BORU KROŞESİ KAPAKLI (GEÇMELİ)		100 ad.	3500	8,15
074 048 050025	Ø25 ANTİGRON BORU KROŞESİ KAPAKLI (GEÇMELİ)		100 ad.	3000	8,89
074 048 050032	Ø32 ANTİGRON BORU KROŞESİ KAPAKLI (GEÇMELİ)		50 ad.	1500	10,74





Ürün Kodu	Ürün Adı	Kutu Mtre/Ad.	Koli Adet	Fiyat (₺)
BOY BORULAR - HALOJEN FREE - ALEV YAYMAYAN - FLARET - 320N TS CE				
001 045 500016 30 17	Ø16 HALOJEN FREE ALEV YAYMAYAN BORU(3 m)(320N)	102 m		123,99
001 045 500020 30 17	Ø20 HALOJEN FREE ALEV YAYMAYAN BORU(3 m)(320N)	102 m		149,42
001 045 500025 30 17	Ø25 HALOJEN FREE ALEV YAYMAYAN BORU(3 m)(320N)	102 m		205,55
001 045 500032 30 17	Ø32 HALOJEN FREE ALEV YAYMAYAN BORU(3 m)(320N)	102 m		288,94
001 045 500040 30 17	Ø40 HALOJEN FREE ALEV YAYMAYAN BORU(3 m)(320N)	51 m		414,19
001 045 500050 30 17	Ø50 HALOJEN FREE ALEV YAYMAYAN BORU(3 m)(320N)	30 m		670,52
BOY BORULAR - HALOJEN FREE - ALEV YAYMAYAN - FLARET - 750N TS CE				
001 045 510016 30 17	Ø16 HALOJEN FREE ALEV YAYMAYAN BORU(3 m)(750N)	102 m		130,19
001 045 510020 30 17	Ø20 HALOJEN FREE ALEV YAYMAYAN BORU(3 m)(750N)	102 m		162,24
001 045 510025 30 17	Ø25 HALOJEN FREE ALEV YAYMAYAN BORU(3 m)(750N)	102 m		218,37
001 045 510032 30 17	Ø32 HALOJEN FREE ALEV YAYMAYAN BORU(3 m)(750N)	102 m		307,25
001 045 510040 30 17	Ø40 HALOJEN FREE ALEV YAYMAYAN BORU(3 m)(750N)	51 m		438,65
001 045 510050 30 17	Ø50 HALOJEN FREE ALEV YAYMAYAN BORU(3 m)(750N)	30 m		765,32
BOY BORULAR - HALOJEN FREE - ALEV YAYMAYAN - FLARET - 1250N TS CE				
001 045 520016 30 17	Ø16 HALOJEN FREE ALEV YAYMAYAN BORU(3 m)(1250N)	102 m		141,47
001 045 520020 30 17	Ø20 HALOJEN FREE ALEV YAYMAYAN BORU(3 m)(1250N)	102 m		173,51
001 045 520025 30 17	Ø25 HALOJEN FREE ALEV YAYMAYAN BORU(3 m)(1250N)	102 m		237,68
001 045 520032 30 17	Ø32 HALOJEN FREE ALEV YAYMAYAN BORU(3 m)(1250N)	102 m		342,89
001 045 520040 30 17	Ø40 HALOJEN FREE ALEV YAYMAYAN BORU(3 m)(1250N)	51 m		467,81
001 045 520050 30 17	Ø50 HALOJEN FREE ALEV YAYMAYAN BORU(3 m)(1250N)	30 m		853,44
BORU - SİRAL EK MUF - ALEV YAYMAYAN				
999 999 777616	16'LİK BORU-SİRAL EK MUFU ALEV YAYMAYAN	100 ad.	4000	26,00
999 999 777620	20'LİK BORU-SİRAL EK MUFU ALEV YAYMAYAN	100 ad.	2000	28,17
999 999 777625	25'LİK BORU-SİRAL EK MUFU ALEV YAYMAYAN	100 ad.	2000	37,28
999 999 777632	32'LİK BORU-SİRAL EK MUFU ALEV YAYMAYAN	100 ad.	1000	39,00
DÜZ BORU T DİRSEK - ALEV YAYMAYAN				
999 999 999888	16'LİK DÜZ BORU T DİRSEK ALEV YAYMAYAN	100 ad.	1500	47,67
999 999 999889	20'LİK DÜZ BORU T DİRSEK ALEV YAYMAYAN	100 ad.	1000	56,32
999 999 999890	25'LİK DÜZ BORU T DİRSEK ALEV YAYMAYAN	50 ad.	800	69,33
999 999 999891	32'LİK DÜZ BORU T DİRSEK ALEV YAYMAYAN	25 ad.	500	91,00
DÜZ BORU RAKORU - ALEV YAYMAYAN				
999 999 998816	Ø16 DÜZ BORU REKORU ALEV YAYMAYAN	100 ad.	4000	48,15
999 999 998820	Ø20 DÜZ BORU REKORU ALEV YAYMAYAN	100 ad.	2500	59,26
999 999 998825	Ø25 DÜZ BORU REKORU ALEV YAYMAYAN	100 ad.	2000	70,37
999 999 998832	Ø32 DÜZ BORU REKORU ALEV YAYMAYAN	100 ad.	1000	92,59
ANTİGRON BORU KROŞESİ (GEÇMELİ) - ALEV YAYMAYAN				
074 048 060016	Ø16 ANTİGRON BORU KROŞESİ (GEÇMELİ TİP) KAPAKLI ALEV YAYMAYAN	100 ad.	4000	13,00
074 048 060020	Ø20 ANTİGRON BORU KROŞESİ (GEÇMELİ TİP) KAPAKLI ALEV YAYMAYAN	100 ad.	3500	14,33
074 048 060025	Ø25 ANTİGRON BORU KROŞESİ (GEÇMELİ TİP) KAPAKLI ALEV YAYMAYAN	100 ad.	3000	16,94
074 048 060032	Ø32 ANTİGRON BORU KROŞESİ (GEÇMELİ TİP) KAPAKLI ALEV YAYMAYAN	100 ad.	2000	20,83
SİRAL RAKORU - ALEV YAYMAYAN				
999 999 777516	Ø16 KAPAKLI SİRAL REKORU ALEV YAYMAYAN	100 ad.	4000	49,83
999 999 777520	Ø20 KAPAKLI SİRAL REKORU ALEV YAYMAYAN	100 ad.	3000	56,33
999 999 777525	Ø25 KAPAKLI SİRAL REKORU ALEV YAYMAYAN	100 ad.	1800	73,67
999 999 777532	Ø32 KAPAKLI SİRAL REKORU ALEV YAYMAYAN	100 ad.	1000	95,33



Ürün Kodu	Ürün Adı		Kutu Metre/Ad.	Fiyat (₺)
YENİ MUTLUSAN EKO SERİSİ TURUNCU BORULAR - HALOJEN FREE - ALEV YAYAN - 320N - 6 ATÜ				
001 165 710014 00 12	Ø14/6 ATÜ BORU (HALOJEN FREE TURUNCU) (ALEV YAYAN) (EKO)	☐ ☐	200 m	14,24
001 165 710016 00 12	Ø16/6 ATÜ BORU (HALOJEN FREE TURUNCU) (ALEV YAYAN) (EKO)	☐ ☐ ☐	200 m	17,07
001 165 710018 00 12	Ø18/6 ATÜ BORU (HALOJEN FREE TURUNCU) (ALEV YAYAN) (EKO)	☐ ☐	200 m	19,69
001 165 710020 00 12	Ø20/6 ATÜ BORU (HALOJEN FREE TURUNCU) (ALEV YAYAN) (EKO)	☐ ☐ ☐	200 m	21,55
001 165 710025 00 12	Ø25/6 ATÜ BORU (HALOJEN FREE TURUNCU) (ALEV YAYAN) (EKO)	☐ ☐ ☐	100 m	35,26
001 165 710032 00 12	Ø32/6 ATÜ BORU (HALOJEN FREE TURUNCU) (ALEV YAYAN) (EKO)	☐ ☐ ☐	100 m	54,22
001 165 710040 00 12	Ø40/6 ATÜ BORU (HALOJEN FREE TURUNCU) (ALEV YAYAN) (EKO)	☐ ☐ ☐	100 m	81,65
001 165 710050 00 12	Ø50/6 ATÜ BORU (HALOJEN FREE TURUNCU) (ALEV YAYAN) (EKO)	☐ ☐ ☐	100 m	142,15
YENİ MUTLUSAN EKO SERİSİ MAVİ BORULAR - HALOJEN FREE - ALEV YAYAN - 320N - 6 ATÜ				
001 165 710014 00 13	Ø14/6 ATÜ BORU (HALOJEN FREE MAVİ) (ALEV YAYAN) (EKO)	☐ ☐	200 m	14,24
001 165 710016 00 13	Ø16/6 ATÜ BORU (HALOJEN FREE MAVİ) (ALEV YAYAN) (EKO)	☐ ☐ ☐	200 m	17,07
001 165 710018 00 13	Ø18/6 ATÜ BORU (HALOJEN FREE MAVİ) (ALEV YAYAN) (EKO)	☐ ☐	200 m	19,69
001 165 710020 00 13	Ø20/6 ATÜ BORU (HALOJEN FREE MAVİ) (ALEV YAYAN) (EKO)	☐ ☐ ☐	200 m	21,55
001 165 710025 00 13	Ø25/6 ATÜ BORU (HALOJEN FREE MAVİ) (ALEV YAYAN) (EKO)	☐ ☐ ☐	100 m	35,26
001 165 710032 00 13	Ø32/6 ATÜ BORU (HALOJEN FREE MAVİ) (ALEV YAYAN) (EKO)	☐ ☐ ☐	100 m	54,22
001 165 710040 00 13	Ø40/6 ATÜ BORU (HALOJEN FREE MAVİ) (ALEV YAYAN) (EKO)	☐ ☐ ☐	100 m	81,65
001 165 710050 00 13	Ø50/6 ATÜ BORU (HALOJEN FREE MAVİ) (ALEV YAYAN) (EKO)	☐ ☐ ☐	100 m	142,15
MEKS SERİSİ TURUNCU BORULAR - HALOJEN FREE - ALEV YAYAN - 320N - 6 ATÜ				
001 165 506014 00 12	Ø14/6 ATÜ BORU (HALOJEN FREE)(ALEV YAYAN)	☐ ☐	100 m	19,34
001 165 506016 00 12	Ø16/6 ATÜ BORU (HALOJEN FREE)(ALEV YAYAN)	☐ ☐ ☐	100 m	22,13
001 165 506018 00 12	Ø18/6 ATÜ BORU (HALOJEN FREE)(ALEV YAYAN)	☐ ☐	100 m	24,83
001 165 506020 00 12	Ø20/6 ATÜ BORU (HALOJEN FREE)(ALEV YAYAN)	☐ ☐ ☐	100 m	27,27
001 165 506025 00 12	Ø25/6 ATÜ BORU (HALOJEN FREE)(ALEV YAYAN)	☐ ☐ ☐	100 m	38,22
001 165 506032 00 12	Ø32/6 ATÜ BORU (HALOJEN FREE)(ALEV YAYAN)	☐ ☐ ☐	100 m	57,01
001 165 506037 00 12	Ø37/6 ATÜ BORU (HALOJEN FREE)(ALEV YAYAN)	☐ ☐	100 m	83,75
001 165 506040 00 12	Ø40/6 ATÜ BORU (HALOJEN FREE)(ALEV YAYAN)	☐ ☐ ☐	100 m	87,63
001 165 506050 00 12	Ø50/6 ATÜ BORU (HALOJEN FREE)(ALEV YAYAN)	☐ ☐ ☐	100 m	143,09
001 165 506063 00 12	Ø63/6 ATÜ BORU (HALOJEN FREE)(ALEV YAYAN)	☐ ☐ ☐	100 m	192,15
001 165 506075 00 12	Ø75/6 ATÜ BORU (HALOJEN FREE)(ALEV YAYAN)	☐ ☐ ☐	100 m	256,78
001 165 506090 00 12	Ø90/6 ATÜ BORU (HALOJEN FREE)(ALEV YAYAN)	☐ ☐ ☐	75 m	382,60
MEKS SERİSİ TURUNCU BORULAR - HALOJEN FREE - ALEV YAYAN - 750N - 10 ATÜ				
001 165 510014 00 12	Ø14/10 ATÜ BORU (HALOJEN FREE)(ALEV YAYAN)	☐ ☐	100 m	20,75
001 165 510016 00 12	Ø16/10 ATÜ BORU (HALOJEN FREE)(ALEV YAYAN)	☐ ☐ ☐	100 m	23,39
001 165 510018 00 12	Ø18/10 ATÜ BORU (HALOJEN FREE)(ALEV YAYAN)	☐ ☐	100 m	27,20
001 165 510020 00 12	Ø20/10 ATÜ BORU (HALOJEN FREE)(ALEV YAYAN)	☐ ☐ ☐	100 m	32,15
001 165 510025 00 12	Ø25/10 ATÜ BORU (HALOJEN FREE)(ALEV YAYAN)	☐ ☐ ☐	100 m	40,93
001 165 510032 00 12	Ø32/10 ATÜ BORU (HALOJEN FREE)(ALEV YAYAN)	☐ ☐ ☐	100 m	60,06
001 165 510037 00 12	Ø37/10 ATÜ BORU (HALOJEN FREE)(ALEV YAYAN)	☐ ☐	100 m	95,49
001 165 510040 00 12	Ø40/10 ATÜ BORU (HALOJEN FREE)(ALEV YAYAN)	☐ ☐ ☐	100 m	100,31
001 165 510050 00 12	Ø50/10 ATÜ BORU (HALOJEN FREE)(ALEV YAYAN)	☐ ☐ ☐	100 m	165,00
001 165 510063 00 12	Ø63/10 ATÜ BORU (HALOJEN FREE)(ALEV YAYAN)	☐ ☐ ☐	100 m	216,32
001 165 510075 00 12	Ø75/10 ATÜ BORU (HALOJEN FREE)(ALEV YAYAN)	☐ ☐ ☐	100 m	298,84
001 165 510090 00 12	Ø90/10 ATÜ BORU (HALOJEN FREE)(ALEV YAYAN)	☐ ☐ ☐	75 m	416,67
001 165 510100 00 12	Ø100/10 ATÜ BORU (HALOJEN FREE)(ALEV YAYAN)	☐ ☐	75 m	516,96
001 165 510110 00 12	Ø110/10 ATÜ BORU (HALOJEN FREE)(ALEV YAYAN)	☐ ☐	50 m	610,18
MEKS SERİSİ TURUNCU BORULAR - HALOJEN FREE - ALEV YAYAN - 1250N				
001 165 512020 00 12	20 Ø BORU (HALOJEN FREE)(ALEV YAYAN)	☐ ☐ ☐	100 m	67,91
001 165 512025 00 12	25 Ø BORU (HALOJEN FREE)(ALEV YAYAN)	☐ ☐ ☐	100 m	83,06
001 165 512032 00 12	32 Ø BORU (HALOJEN FREE)(ALEV YAYAN)	☐ ☐ ☐	100 m	123,41





Ürün Kodu	Ürün Adı	Kutu Mt./Ad.	Fiyat (₺)
MEKS SERİSİ TURUNCU BORULAR - HALOJEN FREE - ALEV YAYMAYAN - 320N - 6 ATÜ			
001 165 106014 00 12	Ø14/6 ATÜ BORU (HALOJEN FREE)(ALEV YAYMAYANYAYMAYAN)	100 m	27,39
001 165 106016 00 12	Ø16/6 ATÜ BORU (HALOJEN FREE)(ALEV YAYMAYANYAYMAYAN)	100 m	31,88
001 165 106018 00 12	Ø18/6 ATÜ BORU (HALOJEN FREE)(ALEV YAYMAYANYAYMAYAN)	100 m	36,34
001 165 106020 00 12	Ø20/6 ATÜ BORU (HALOJEN FREE)(ALEV YAYMAYANYAYMAYAN)	100 m	40,00
001 165 106025 00 12	Ø25/6 ATÜ BORU (HALOJEN FREE)(ALEV YAYMAYANYAYMAYAN)	100 m	57,99
001 165 106032 00 12	Ø32/6 ATÜ BORU (HALOJEN FREE)(ALEV YAYMAYANYAYMAYAN)	100 m	85,42
001 165 106037 00 12	Ø37/6 ATÜ BORU (HALOJEN FREE)(ALEV YAYMAYANYAYMAYAN)	100 m	124,54
001 165 106040 00 12	Ø40/6 ATÜ BORU (HALOJEN FREE)(ALEV YAYMAYANYAYMAYAN)	100 m	142,49
001 165 106050 00 12	Ø50/6 ATÜ BORU (HALOJEN FREE)(ALEV YAYMAYANYAYMAYAN)	100 m	209,12
001 165 106063 00 12	Ø63/6 ATÜ BORU (HALOJEN FREE)(ALEV YAYMAYANYAYMAYAN)	100 m	281,91
001 165 106075 00 12	Ø75/6 ATÜ BORU (HALOJEN FREE)(ALEV YAYMAYANYAYMAYAN)	100 m	370,21
001 165 106090 00 12	Ø90/6 ATÜ BORU (HALOJEN FREE)(ALEV YAYMAYANYAYMAYAN)	75 m	572,88
MEKS SERİSİ TURUNCU BORULAR - HALOJEN FREE - ALEV YAYMAYAN - 750N - 10 ATÜ			
001 165 110014 00 12	Ø14/10 ATÜ BORU (HALOJEN FREE)(ALEV YAYMAYANYAYMAYAN)	100 m	29,73
001 165 110016 00 12	Ø16/10 ATÜ BORU (HALOJEN FREE)(ALEV YAYMAYANYAYMAYAN)	100 m	34,71
001 165 110018 00 12	Ø18/10 ATÜ BORU (HALOJEN FREE)(ALEV YAYMAYANYAYMAYAN)	100 m	41,37
001 165 110020 00 12	Ø20/10 ATÜ BORU (HALOJEN FREE)(ALEV YAYMAYANYAYMAYAN)	100 m	50,48
001 165 110025 00 12	Ø25/10 ATÜ BORU (HALOJEN FREE)(ALEV YAYMAYANYAYMAYAN)	100 m	63,72
001 165 110032 00 12	Ø32/10 ATÜ BORU (HALOJEN FREE)(ALEV YAYMAYANYAYMAYAN)	100 m	98,44
001 165 110037 00 12	Ø37/10 ATÜ BORU (HALOJEN FREE)(ALEV YAYMAYANYAYMAYAN)	100 m	155,74
001 165 110040 00 12	Ø40/10 ATÜ BORU (HALOJEN FREE)(ALEV YAYMAYANYAYMAYAN)	100 m	163,40
001 165 110050 00 12	Ø50/10 ATÜ BORU (HALOJEN FREE)(ALEV YAYMAYANYAYMAYAN)	100 m	248,31
001 165 110063 00 12	Ø63/10 ATÜ BORU (HALOJEN FREE)(ALEV YAYMAYANYAYMAYAN)	100 m	319,33
001 165 110075 00 12	Ø75/10 ATÜ BORU (HALOJEN FREE)(ALEV YAYMAYANYAYMAYAN)	100 m	447,18
001 165 110090 00 12	Ø90/10 ATÜ BORU (HALOJEN FREE)(ALEV YAYMAYANYAYMAYAN)	75 m	631,39
001 165 110100 00 12	Ø100/10 ATÜ BORU (HALOJEN FREE)(ALEV YAYMAYANYAYMAYAN)	75 m	816,93
001 165 110110 00 12	Ø110/10 ATÜ BORU (HALOJEN FREE)(ALEV YAYMAYANYAYMAYAN)	50 m	1.010,53
MEKS SERİSİ BORULAR - HALOJEN FREE - ALEV YAYMAYAN - 1250N			
001 165 112020 00 12	Ø20 BORU (HALOJEN FREE)(ALEV YAYMAYANYAYMAYAN)	100 m	95,66
001 165 112025 00 12	Ø25 BORU (HALOJEN FREE)(ALEV YAYMAYANYAYMAYAN)	100 m	122,39
001 165 112032 00 12	Ø32 BORU (HALOJEN FREE)(ALEV YAYMAYANYAYMAYAN)	100 m	189,68
MEKS SERİSİ TURUNCU BORU - HALOJEN FREE - ALEV YAYAN - TELLİ - 320N - 6 ATÜ			
001 165 906014 00 12	Ø14/6 ATÜ BORU(HALOJEN FREE)(ALEV YAYMAYANYAYAN)(TELLİ)(TURUNCU)	100 m	20,96
001 165 906016 00 12	Ø16/6 ATÜ BORU(HALOJEN FREE)(ALEV YAYMAYANYAYAN)(TELLİ)(TURUNCU)	100 m	23,75
001 165 906018 00 12	Ø18/6 ATÜ BORU(HALOJEN FREE)(ALEV YAYMAYANYAYAN)(TELLİ)(TURUNCU)	100 m	26,45
001 165 906020 00 12	Ø20/6 ATÜ BORU(HALOJEN FREE)(ALEV YAYMAYANYAYAN)(TELLİ)(TURUNCU)	100 m	28,89
001 165 906025 00 12	Ø25/6 ATÜ BORU(HALOJEN FREE)(ALEV YAYMAYANYAYAN)(TELLİ)(TURUNCU)	100 m	39,84
001 165 906032 00 12	Ø32/6 ATÜ BORU(HALOJEN FREE)(ALEV YAYMAYANYAYAN)(TELLİ)(TURUNCU)	100 m	58,63
001 165 906037 00 12	Ø37/6 ATÜ BORU(HALOJEN FREE)(ALEV YAYMAYANYAYAN)(TELLİ)(TURUNCU)	100 m	85,37
001 165 906040 00 12	Ø40/6 ATÜ BORU(HALOJEN FREE)(ALEV YAYMAYANYAYAN)(TELLİ)(TURUNCU)	100 m	89,25
MEKS SERİSİ TURUNCU BORU - HALOJEN FREE - ALEV YAYAN - TELLİ - 750N - 10 ATÜ			
001 165 910014 00 12	Ø14/10 ATÜ BORU(HALOJEN FREE)(ALEV YAYMAYANYAYAN)(TELLİ)(TURUNCU)	100 m	22,37
001 165 910016 00 12	Ø16/10 ATÜ BORU(HALOJEN FREE)(ALEV YAYMAYANYAYAN)(TELLİ)(TURUNCU)	100 m	25,01
001 165 910018 00 12	Ø18/10 ATÜ BORU(HALOJEN FREE)(ALEV YAYMAYANYAYAN)(TELLİ)(TURUNCU)	100 m	28,82
001 165 910020 00 12	Ø20/10 ATÜ BORU(HALOJEN FREE)(ALEV YAYMAYANYAYAN)(TELLİ)(TURUNCU)	100 m	33,77
001 165 910025 00 12	Ø25/10 ATÜ BORU(HALOJEN FREE)(ALEV YAYMAYANYAYAN)(TELLİ)(TURUNCU)	100 m	42,55
001 165 910032 00 12	Ø32/10 ATÜ BORU(HALOJEN FREE)(ALEV YAYMAYANYAYAN)(TELLİ)(TURUNCU)	100 m	61,68
001 165 910037 00 12	Ø37/10 ATÜ BORU(HALOJEN FREE)(ALEV YAYMAYANYAYAN)(TELLİ)(TURUNCU)	100 m	97,11
001 165 910040 00 12	Ø40/10 ATÜ BORU(HALOJEN FREE)(ALEV YAYMAYANYAYAN)(TELLİ)(TURUNCU)	100 m	101,94
MEKS SERİSİ BORULAR - HALOJEN FREE - ALEV YAYMAYAN - TELLİ - 320N - 6 ATÜ			
001 165 306014 00 12	Ø14/6 ATÜ BORU(HALOJEN FREE)(ALEV YAYMAYANYAYMAYAN)(TELLİ)(TURUNCU)	100 m	29,01
001 165 306016 00 12	Ø16/6 ATÜ BORU(HALOJEN FREE)(ALEV YAYMAYANYAYMAYAN)(TELLİ)(TURUNCU)	100 m	33,50
001 165 306018 00 12	Ø18/6 ATÜ BORU(HALOJEN FREE)(ALEV YAYMAYANYAYMAYAN)(TELLİ)(TURUNCU)	100 m	37,96
001 165 306020 00 12	Ø20/6 ATÜ BORU(HALOJEN FREE)(ALEV YAYMAYANYAYMAYAN)(TELLİ)(TURUNCU)	100 m	41,62
001 165 306025 00 12	Ø25/6 ATÜ BORU(HALOJEN FREE)(ALEV YAYMAYANYAYMAYAN)(TELLİ)(TURUNCU)	100 m	59,61
001 165 306032 00 12	Ø32/6 ATÜ BORU(HALOJEN FREE)(ALEV YAYMAYANYAYMAYAN)(TELLİ)(TURUNCU)	100 m	87,04
001 165 306037 00 12	Ø37/6 ATÜ BORU(HALOJEN FREE)(ALEV YAYMAYANYAYMAYAN)(TELLİ)(TURUNCU)	100 m	126,16
001 165 306040 00 12	Ø40/6 ATÜ BORU(HALOJEN FREE)(ALEV YAYMAYANYAYMAYAN)(TELLİ)(TURUNCU)	100 m	144,11

Ürün Kodu	Ürün Adı	Kutu Mt./Ad.	Fiyat (₺)
MEKS SERİSİ BORULAR - HALOJEN FREE - ALEV YAYMAYAN - TELLİ - 750N - 10 ATÜ			
001 165 310014 00 12	Ø14/10 ATÜ BORU(H.FREE)(ALEV YAYMAYANYAYMAYAN)(TELLİ)(TURUNCU)	100 m	31,35
001 165 310016 00 12	Ø16/10 ATÜ BORU(H.FREE)(ALEV YAYMAYANYAYMAYAN)(TELLİ)(TURUNCU)	100 m	36,33
001 165 310018 00 12	Ø18/10 ATÜ BORU(H.FREE)(ALEV YAYMAYANYAYMAYAN)(TELLİ)(TURUNCU)	100 m	42,99
001 165 310020 00 12	Ø20/10 ATÜ BORU(H.FREE)(ALEV YAYMAYANYAYMAYAN)(TELLİ)(TURUNCU)	100 m	52,10
001 165 310025 00 12	Ø25/10 ATÜ BORU(H.FREE)(ALEV YAYMAYANYAYMAYAN)(TELLİ)(TURUNCU)	100 m	65,34
001 165 310032 00 12	Ø32/10 ATÜ BORU(H.FREE)(ALEV YAYMAYANYAYMAYAN)(TELLİ)(TURUNCU)	100 m	100,07
001 165 310037 00 12	Ø37/10 ATÜ BORU(H.FREE)(ALEV YAYMAYANYAYMAYAN)(TELLİ)(TURUNCU)	100 m	157,36
001 165 310040 00 12	Ø40/10 ATÜ BORU(H.FREE)(ALEV YAYMAYANYAYMAYAN)(TELLİ)(TURUNCU)	100 m	165,02



Ürün Kodu	Ürün Adı	Kutu Mt./Ad.	Koli Adet	Fiyat (₺)
PLASTİK BORULAR				
001 045 000014 30 00	14 mm KALIN BOY BORU	102 m	510 m	17,15
001 045 000018 30 00	18 mm KALIN BOY BORU	102 m	510 m	20,38
001 045 000026 30 00	26 mm KALIN BOY BORU	51 m	255 m	34,87
001 045 000037 30 00	37 mm KALIN BOY BORU	30 m		64,67
001 045 010014 00 11	14 mm KANGAL (NORMAL)	100 m		17,15
001 045 010018 00 11	18 mm KANGAL (NORMAL)	100 m		20,38
001 045 010026 00 11	26 mm KANGAL (NORMAL)	50 m		34,87
001 045 010037 00 11	37 mm KANGAL (NORMAL)	50 m		78,99
001 045 020014 00 00	14 mm KANGAL (KAUÇUK)	100 m		17,30
001 045 020018 00 00	18 mm KANGAL (KAUÇUK)	100 m		20,84
001 045 020026 00 00	26 mm KANGAL (KAUÇUK)	50 m		35,34
001 045 020037 00 00	37 mm KANGAL (KAUÇUK)	50 m		81,48
001 045 030014 00 00	14 mm KANGAL (KAUÇUK) (KALIN)	100 m		19,58
001 045 030018 00 00	18 mm KANGAL (KAUÇUK) (KALIN)	100 m		21,98



Ürün Kodu	Ürün Adı	Kutu Mt./Ad.	Koli Adet	Fiyat (₺)
PLASTİK DİRSEK VE MUFLAR				
127 051 000014	PLASTİK 14 Ø DİRSEK	100 ad.	2000	6,02
127 051 000018	PLASTİK 18 Ø DİRSEK	100 ad.	1000	7,56
127 051 000026	PLASTİK 26 Ø DİRSEK	100 ad.	500	13,58
001 051 020014 00 11	PLASTİK 14 Ø MUF		1500	7,41
001 051 020018 00 11	PLASTİK 18 Ø MUF		1000	13,33
001 051 020026 00 11	PLASTİK 26 Ø MUF		500	13,89
001 051 020037 00 11	PLASTİK 37 Ø MUF		250	27,78



Ürün Kodu	Ürün Adı	Kutu Mt./Ad.	Koli Adet	Fiyat (₺)
POLİETİLEN SİYAH YERALTI BORULAR - 450N				
001 165 406014 00 11	14/6 ATÜ POLİETİLEN BORU (SİYAH)	€€	100 m	17,39
001 165 406016 00 11	16/6 ATÜ POLİETİLEN BORU (SİYAH)	€€	100 m	19,83
001 165 406018 00 11	18/6 ATÜ POLİETİLEN BORU (SİYAH)	€€	100 m	22,06
001 165 406020 00 11	20/6 ATÜ POLİETİLEN BORU (SİYAH)	€€	100 m	24,09
001 165 406025 00 11	25/6 ATÜ POLİETİLEN BORU (SİYAH)	€€	100 m	33,68
001 165 406032 00 11	32/6 ATÜ POLİETİLEN BORU (SİYAH)	€€	100 m	50,04
001 165 406037 00 11	37/6 ATÜ POLİETİLEN BORU (SİYAH)	€€	100 m	74,14
001 165 406040 00 11	40/6 ATÜ POLİETİLEN BORU (SİYAH)	€€	100 m	75,93
001 165 406050 00 11	50/6 ATÜ POLİETİLEN BORU (SİYAH)	€€	100 m	126,59
001 165 406063 00 11	63/6 ATÜ POLİETİLEN BORU (SİYAH)	€€	100 m	168,70
001 165 406075 00 11	75/6 ATÜ POLİETİLEN BORU (SİYAH)	€€	100 m	228,57
001 165 406090 00 11	90/6 ATÜ POLİETİLEN BORU (SİYAH)	€€	75 m	334,27

Ürün Kodu	Ürün Adı	Kutu Mt./Ad.	Koli Adet	Fiyat (₺)
POLİETİLEN SİYAH YER ALTI BORULAR - 750N				
001 165 410014 00 11	14/10 ATÜ POLİETİLEN BORU (SİYAH)	€€	100 m	18,61
001 165 410016 00 11	16/10 ATÜ POLİETİLEN BORU (SİYAH)	€€	100 m	20,84
001 165 410018 00 11	18/10 ATÜ POLİETİLEN BORU (SİYAH)	€€	100 m	24,09
001 165 410020 00 11	20/10 ATÜ POLİETİLEN BORU (SİYAH)	€€	100 m	28,14
001 165 410025 00 11	25/10 ATÜ POLİETİLEN BORU (SİYAH)	€€	100 m	35,91
001 165 410032 00 11	32/10 ATÜ POLİETİLEN BORU (SİYAH)	€€	100 m	54,50
001 165 410037 00 11	37/10 ATÜ POLİETİLEN BORU (SİYAH)	€€	100 m	80,22
001 165 410040 00 11	40/10 ATÜ POLİETİLEN BORU (SİYAH)	€€	100 m	79,80
001 165 410050 00 11	50/10 ATÜ POLİETİLEN BORU (SİYAH)	€€	100 m	144,85
001 165 410063 00 11	63/10 ATÜ POLİETİLEN BORU (SİYAH)	€€	100 m	182,90
001 165 410075 00 11	75/10 ATÜ POLİETİLEN BORU (SİYAH)	€€	100 m	262,22
001 165 410090 00 11	90/10 ATÜ POLİETİLEN BORU (SİYAH)	€€	75 m	372,16
001 165 410100 00 11	100/10 ATÜ POLİETİLEN BORU (SİYAH)	€€	75 m	453,71
001 165 410110 00 11	110/10 ATÜ POLİETİLEN BORU (SİYAH)	€€	50 m	534,86





Ürün Kodu	Ürün Adı	Kutu Metre	Koli Adet	Fiyat (₺)
-----------	----------	------------	-----------	-----------

FİBER SUSTALAR

999 999 000779	FİBER KILAVUZ 11 mm (100-120-150-200 Metre)	1 m		263,89
999 999 000780	FİBER KILAVUZ MAKARASI	1 ad.		12.962,96

PLASTİK SUSTALAR - KILAVUZ TELLİ

049 019 400010	10 Metre KILAVUZ TELLİ PLASTİK SUSTA	1 ad.	25	254,63
049 019 400015	15 Metre KILAVUZ TELLİ PLASTİK SUSTA	1 ad.	20	381,94
049 019 400020	20 Metre KILAVUZ TELLİ PLASTİK SUSTA	1 ad.	15	509,26
049 019 400025	25 Metre KILAVUZ TELLİ PLASTİK SUSTA	1 ad.	15	636,57

ÇELİK SUSTALAR

001 019 000010 00 00	SUSTA (1.KALİTE) (10 Metre)	40 ad.	40	388,89
001 019 000015 00 00	SUSTA (1.KALİTE) (15 Metre)	30 ad.	30	555,56
001 019 000020 00 00	SUSTA (1.KALİTE) (20 Metre)	20 ad.	20	740,74
001 019 000025 00 00	SUSTA (1.KALİTE) (25 Metre)	15 ad.	15	888,89
001 019 100010 00 00	TAKVİYELİ SUSTA (1.KALİTE)(10 Metre)	40 ad.	40	407,41
001 019 100015 00 00	TAKVİYELİ SUSTA (1.KALİTE)(15 Metre)	30 ad.	30	574,07
001 019 100020 00 00	TAKVİYELİ SUSTA (1.KALİTE)(20 Metre)	20 ad.	20	777,78
001 019 100025 00 00	TAKVİYELİ SUSTA (1.KALİTE)(25 Metre)	15 ad.	15	962,96

Ürün Kodu	Ürün Adı	Kutu Mt./Ad.	Koli Adet	Fiyat (₺)
-----------	----------	--------------	-----------	-----------

PLASTİK KASA - BUAT - TAKOZLAR

001 046 130102 00 11	NORM KASA	100 ad.	1000	6,67
001 046 130101 00 11	NORM BUAT (14-18 ÇIKIŞLI)	50 ad.	500	14,81
001 046 130105 00 11	NORM BUAT KAPAKSIZ	50 ad.	500	11,20
001 046 160102 00 11	GEÇMELİ PLASTİK KASA	100 ad.	400	18,07
001 046 160101 00 11	GEÇMELİ DERİN KASA	100 ad.	500	13,33
001 046 130107 00 11	GEÇMELİ DERİN KASA KAPAKSIZ	100 ad.	500	9,44
001 046 180101 00 11	ÇİFT KİLİTLEMELİ GEÇMELİ DERİN KASA SİYAH	75 ad.	300	34,07
001 046 150000 00 11	GEÇMELİ DERİN KASA UZATMA PARÇASI SİYAH	225 ad.	900	11,11
001 046 120110 00 11	GEÇMELİ ALÇIPAN KASA (KOLAY BAĞLANTILI) SİYAH	60 ad.	240	27,04
001 046 120101 00 11	ALÇIPAN KASA 1'Lİ	75 ad.	300	40,07
001 046 120102 00 11	ALÇIPAN KASA 2'Lİ	50 ad.	200	58,58
001 046 120103 00 11	ALÇIPAN KASA 3'Lİ	25 ad.	100	84,06
001 046 120100 00 11	GEÇMELİ ALÇIPAN KASA - SİYAH	50 ad.	300	25,46
001 046 000001 00 11	PLASTİK TAKOZ (14-18 ÇIKIŞLI)	100 ad.	1000	11,01

TURUNCU KASA VE BUATLAR - HALOJEN FREE - ALEV YAYAN

001 046 130202 00 12	NORM KASA (TURUNCU) (HALOJEN FREE) (ALEV YAYAN)	100 ad.	1000	12,81
001 046 130201 00 12	NORM BUAT (TURUNCU) (HALOJEN FREE) (ALEV YAYAN)	50 ad.	500	21,67
001 046 160201 00 12	GEÇMELİ DERİN KASA (TURUNCU) (HALOJEN FREE) (ALEV YAYAN)	100 ad.	500	24,07

TURUNCU KASA VE BUATLAR - ALEV YAYAN

001 046 130102 00 12	NORM KASA (TURUNCU)(ALEV YAYAN)	100 ad.	1000	9,48
001 046 130101 00 12	NORM BUAT (TURUNCU)(ALEV YAYAN)	50 ad.	500	18,96
001 046 160102 00 12	GEÇMELİ PLASTİK KASA (TURUNCU)(ALEV YAYAN)	100 ad.	400	21,85
001 046 160101 00 12	GEÇMELİ DERİN KASA (TURUNCU)(ALEV YAYAN)	100 ad.	500	22,22
001 046 180101 00 12	ÇİFT KİLİTLEMELİ GEÇMELİ DERİN KASA TURUNCU	75 ad.	300	34,26
001 046 150000 00 12	GEÇMELİ DERİN KASA UZATMA PARÇASI TURUNCU	225 ad.	900	11,44
001 046 120110 00 12	GEÇMELİ ALÇIPAN KASA (KOLAY BAĞLANTILI) TURUNCU	60 ad.	240	29,86
001 046 120101 00 12	ALÇIPAN KASA 1'Lİ (TURUNCU)(ALEV YAYAN)	75 ad.	300	42,30
001 046 120102 00 12	ALÇIPAN KASA 2'Lİ (TURUNCU)(ALEV YAYAN)	50 ad.	200	62,52
001 046 120103 00 12	ALÇIPAN KASA 3'LÜ (TURUNCU)(ALEV YAYAN)	25 ad.	100	89,16
001 046 120100 00 12	GEÇMELİ ALÇIPAN KASA (TURUNCU)(ALEV YAYAN)	50 ad.	300	26,39

001 046 130101 00 11

001 046 130102 00 12

001 046 130102 00 11

001 046 130107 00 11

001 046 160101 00 12

001 046 150001 00 11

001 046 180101 00 11

001 046 180101 00 12

001 046 120110 00 12

001 046 120102 00 12

001 046 120101 00 12

001 046 120103 00 12

001 046 120100 00 12

Ürün Kodu	Ürün Adı	Kutu Adet	Koli Adet	Fiyat (₺)
TURUNCU KASA VE BUATLAR - ALEV YAYMAYAN				
001 046 131102 00 12	NORM KASA (TURUNCU)(ALEV YAYMAYAN)	100 ad.	1000	11,38
001 046 131101 00 12	NORM BUAT (TURUNCU)(ALEV YAYMAYAN)	50 ad.	500	21,70
001 046 161102 00 12	GEÇMELİ PLASTİK KASA (TURUNCU)(ALEV YAYMAYAN)	100 ad.	400	42,27
001 046 161101 00 12	GEÇMELİ DERİN KASA (TURUNCU)(ALEV YAYMAYAN)	100 ad.	500	26,20
001 046 181101 00 12	ÇİFT KİLİTLEMELİ GEÇMELİ DERİN KASA TURUNCU	75 ad.	300	27,04
001 046 181201 00 12	ÇİFT KİLİT. GEÇ. DERİN KASA TURUNCU A.YAYMAYAN (H.FREE)	75 ad.	300	49,26
001 046 150001 00 12	GEÇMELİ DERİN KASA UZATMA PARÇASI TURUNCU	225 ad.	900	22,22
001 046 121101 00 12	ALÇIPAN KASA 1'Lİ (TURUNCU)(ALEV YAYMAYAN)	75 ad.	300	51,60
001 046 121102 00 12	ALÇIPAN KASA 2'Lİ (TURUNCU)(ALEV YAYMAYAN)	50 ad.	200	76,67
001 046 121103 00 12	ALÇIPAN KASA 3'LÜ (TURUNCU)(ALEV YAYMAYAN)	25 ad.	100	108,45
001 046 121100 00 12	GEÇMELİ ALÇIPAN KASA (TURUNCU)(ALEV YAYMAYAN)	50 ad.	300	32,59



001 046 1210102 00 12

001 046 120101 00 12



001 046 121103 00 12



001 046 121100 00 12

KARE BUAT

001 046 021010 00 11	10X10 KARE BUAT (SİYAH)	10 ad.	300	152,32
001 046 021212 00 11	12X12 KARE BUAT (SİYAH)	10 ad.	200	153,69
001 046 021515 00 11	15X15 KARE BUAT (SİYAH)	10 ad.	120	208,35
001 046 022020 00 11	20X20 KARE BUAT (SİYAH)	10 ad.	70	245,17
001 046 000103 00 11	ANTİGRON BUAT 3'LÜ PLASTİK (SİYAH)	10 ad.	240	107,41
001 046 000104 00 11	ANTİGRON BUAT 4'LÜ PLASTİK (SİYAH)	10 ad.	240	122,22
001 046 000103 00 00	ANTİGRON BUAT 3'LÜ PLASTİK (BEYAZ)	10 ad.	240	107,41
001 046 000104 00 00	ANTİGRON BUAT 4'LÜ PLASTİK (BEYAZ)	10 ad.	240	122,22
001 046 021010 00 12	10X10 KARE BUAT TURUNCU	10 ad.	300	159,94
001 046 021212 00 12	12X12 KARE BUAT TURUNCU	10 ad.	200	161,37
001 046 021515 00 12	15X15 KARE BUAT TURUNCU	10 ad.	120	218,77
001 046 022020 00 12	20X20 KARE BUAT TURUNCU	10 ad.	70	257,43
001 046 000103 00 12	ANTİGRON BUAT 3'LÜ TURUNCU	10 ad.	240	120,11
001 046 000104 00 12	ANTİGRON BUAT 4'LÜ TURUNCU	10 ad.	240	136,62



001 046 021212 00 11



001 046 021212 00 12



001 046 000103 00 00



001 046 000103 00 11

TURUNCU KARE BUAT - ALEV YAYMAYAN



001 046 051010 00 12	KARE BUAT TURUNCU(10X10) (ALEV YAYMAYAN)	10 ad.	300	167,93
001 046 051212 00 12	KARE BUAT TURUNCU(12X12) (ALEV YAYMAYAN)	10 ad.	200	169,44
001 046 051515 00 12	KARE BUAT TURUNCU(15X15) (ALEV YAYMAYAN)	10 ad.	120	240,74
001 046 052020 00 12	KARE BUAT TURUNCU(20X20) (ALEV YAYMAYAN)	10 ad.	70	296,30

LÜKS BUAT KAPAKLARI

126 046 180001	LÜKS BUAT KAPAĞI (BOMBELİ-PLASTİK AYAK)	100 ad.	1000	8,00
126 046 180003	LÜKS BUAT KAPAĞI (DÜZ - PLASTİK AYAK)	100 ad.	1000	8,00
126 046 180004	LÜKS BUAT KAPAĞI (BOMBELİ PLASTİK AYAK)VİDALI	100 ad.	1000	22,22



126 046 180001

126 046 180004

KARE BUAT KAPAKLARI

000 700 000043 00 00	10X10 KARE BUAT KAPAĞI	1 ad.	300	27,78
000 700 000045 00 00	12X12 KARE BUAT KAPAĞI	1 ad.	350	31,48
000 700 000047 00 00	15X15 KARE BUAT KAPAĞI	1 ad.	260	46,30
000 700 000049 00 00	20X20 KARE BUAT KAPAĞI	1 ad.	140	77,78



000 700 000047 00 00

Ürün Kodu	Ürün Adı	Kutu Adet	Koli Adet	Fiyat (₺)
GALVANİZLİ SAC KROŞELER				
001 048 060001 00 00	NO. 1 TEKLİ GALVANİZ SAC KROŞE 12 mm	1500 ad.		4,17
001 048 060002 00 00	NO. 2 TEKLİ GALVANİZ SAC KROŞE 14 mm	1000 ad.		4,33
001 048 060003 00 00	NO. 3 TEKLİ GALVANİZ SAC KROŞE 17 mm	700 ad.		4,62
001 048 060004 00 00	NO. 4 TEKLİ GALVANİZ SAC KROŞE 20 mm	500 ad.		5,02
001 048 060007 00 00	NO. 7 TEKLİ GALVANİZ SAC KROŞE 26 mm	350 ad.		6,13
001 048 060008 00 00	NO. 8 TEKLİ GALVANİZ SAC KROŞE 34 mm	250 ad.		16,40
001 048 060009 00 00	NO. 9 TEKLİ GALVANİZ SAC KROŞE 43 mm	200 ad.		18,60
001 048 060010 00 00	NO. 10 TEKLİ GALVANİZ SAC KROŞE 53 mm	150 ad.		19,86
001 048 060011 00 00	NO. 11 TEKLİ GALVANİZ SAC KROŞE 55 mm	120 ad.		22,13
001 048 070002 00 00	NO. 2 ÇİFTLİ GALVANİZ SAC KROŞE 13 mm	600 ad.		4,64
001 048 070003 00 00	NO. 3 ÇİFTLİ GALVANİZ SAC KROŞE 16 mm	500 ad.		5,34
001 048 070004 00 00	NO. 4 ÇİFTLİ GALVANİZ SAC KROŞE 22 mm	400 ad.		5,41
001 048 070007 00 00	NO. 7 ÇİFTLİ GALVANİZ SAC KROŞE 25 mm	400 ad.		6,38
001 048 070008 00 00	NO. 8 ÇİFTLİ GALVANİZ SAC KROŞE 35 mm	300 ad.		16,67
001 048 070009 00 00	NO. 9 ÇİFTLİ GALVANİZ SAC KROŞE 45 mm	200 ad.		18,89
001 048 070010 00 00	NO. 10 ÇİFTLİ GALVANİZ SAC KROŞE 50 mm	150 ad.		20,00
Ürün Kodu	Ürün Adı	Kutu Adet	Koli Adet	Fiyat (₺)

MUTLUSAN BETON ÇİVİLİ KROŞELER

032 048 070000	NO:0 BETON ÇİVİLİ KROŞE (0.75 YASSI KORDON)	1000 ad.	20000	0,93
032 048 070001	NO:1 BETON ÇİVİLİ KROŞE (0.75 YASSI KORDON)	1000 ad.	20000	0,93
032 048 070002	NO:2 BETON ÇİVİLİ KROŞE (0.75 YASSI KORDON)	1000 ad.	20000	0,93
032 048 070003	NO:3 BETON ÇİVİLİ KROŞE (2X1.5-3X1.5)	1000 ad.	20000	1,26
032 048 070004	NO:4 BETON ÇİVİLİ KROŞE (2X4)	1000 ad.	20000	1,26
032 048 070005	NO:5 BETON ÇİVİLİ KROŞE (2X4-4X4)	1000 ad.	10000	1,74
032 048 070006	NO:6 BETON ÇİVİLİ KROŞE (2X6)	1000 ad.	10000	2,11
032 048 070007	NO:7 BETON ÇİVİLİ KROŞE (4X10)	1000 ad.	5000	3,15
032 048 070008	NO:8 BETON ÇİVİLİ KROŞE (3X16+10)	800 ad.	3200	4,81

RAY KROŞE VE TANDIR KROŞELER

035 048 100001	NO. 1 RAY KROŞE (2X1.5-4X2.5)	350 ad.		15,74
035 048 100002	NO. 2 RAY KROŞE (4X4-4X16)	250 ad.		17,59
001 025 010100 00 00	GALVANİZ KROŞE RAYI (1 Metre)	50 ad.		111,11
035 048 110001	NO. 1 TANDIR KROŞE (2X1.5-2X6)	350 ad.		15,74
035 048 110002	NO. 2 TANDIR KROŞE (4X6)	250 ad.		15,74
035 048 110003	NO. 3 TANDIR KROŞE (4X10)	250 ad.		15,74
035 048 110004	NO. 4 TANDIR KROŞE (4X16)	150 ad.		20,37
035 048 110005	NO. 5 TANDIR KROŞE (3X25+16)	150 ad.		20,37

PLASTİK DÜBELLER

016 053 000014	BURGULU ALÇIPAN DÜBELİ	100 ad.	10000	1,37
001 053 000001 00 00	ALÇIPAN DÜBEL	100 ad.	10000	0,94
001 053 000002 00 00	KANAL DÜBELİ	1000 ad.	10000	0,75
016 053 000006	6 mm BEYAZ DÜBEL	1000 ad.	50000	0,45
016 053 000007	7 mm BEYAZ DÜBEL	1000 ad.	25000	0,49
016 053 000008	8 mm BEYAZ DÜBEL	1000 ad.	25000	0,50

DÜBELLİ KROŞELER

001 048 090002 00 17	3/13 TEKLİ KABLO KROŞESİ	500 ad.	10000	1,44
001 048 090006 00 17	8/28 TEKLİ KABLO KROŞESİ	500 ad.	5000	1,94
001 048 090001 00 00	ÇİFTLİ KABLO KROŞESİ (20'LİK)	100 ad.	8000	2,34
001 048 090002 00 00	ÇİFTLİ KABLO KROŞESİ (25'LİK)	250 ad.	5000	2,42
001 048 090003 00 17	16'LİK BORU KELEPÇESİ	100 ad.	2000	2,21
001 048 090004 00 17	20'LİK BORU KELEPÇESİ	100 ad.	1500	2,60
001 048 090005 00 17	25'LİK BORU KELEPÇESİ	100 ad.	1000	3,32

ELEKTRİK İZOLASYON BANTLARI 0.13mm x 19mm x 10yds (9,14m)

Ürün Kodu	Ürün Adı	Paket Ad.	Koli Ad.	Fiyat (₺)
065 133 001019	PVC ELEKTRİK İZOLE BANDI - SİYAH	10	500	33,33
065 133 011019	PVC ELEKTRİK İZOLE BANDI - BEYAZ	10	500	33,33
065 133 161019	PVC ELEKTRİK İZOLE BANDI - KIRMIZI	10	500	33,33
065 133 131019	PVC ELEKTRİK İZOLE BANDI - MAVİ	10	500	33,33
065 133 141019	PVC ELEKTRİK İZOLE BANDI - SARI	10	500	33,33
065 133 151019	PVC ELEKTRİK İZOLE BANDI - YEŞİL	10	500	33,33
065 133 171019	PVC ELEKTRİK İZOLE BANDI - SARI + YEŞİL	10	500	37,04



001 053 000002 00 00



016 053 000014

001 053 000001 00 00



Evinizin ritmi, kapınızda başlasın!



- 32 Farklı Seçilebilir Melodi
- Pil ile Çalışan Dekoratif Kablosuz Kapı Zili
- Algılama Mesafesi: Açık Alanda 100 Mt.
- Diğer Kablosuz Aygıtlarla Karışmayı Önlemek İçin Frekans Filtresi Kodu
- IP44 Led Işıklı, Etiketli Zil Butonu
- Zil Butonu İçin 1x12V 23A Pil
- İç Ünite İçin 3x1.5V AA Pil

* WA-628 ve WA-638 modellerinin özellikleridir.



888 038 218000



018 105 158100



018 105 114800



018 105 162800



018 105 163800



018 105 162811



018 105 163811

KAPI ZİLLERİ

Kod	Ürün Tanımı	Kutu Adedi	Koli Adedi	Fiyat (\$)
888 038 218000	Q218 KABLOSUZ KAPI ZİLİ LEDLİ 100 Metre - 32 MELODİ	1	10	43,00 \$
018 105 158100	X-581 KAPI ZİLİ - 32 MELODİ	1	10	29,00 \$
018 105 114800	A-148 KAPI ZİLİ - 32 MELODİ	1	10	29,00 \$
018 105 162800	WA-628 KAPI ZİLİ - BEYAZ 32 MELODİ	1	10	36,50 \$
018 105 162811	WA-628 KAPI ZİLİ - SİYAH 32 MELODİ	1	10	36,50 \$
018 105 163800	WA-638 KAPI ZİLİ - BEYAZ 32 MELODİ	1	10	36,50 \$
018 105 163811	WA-638 KAPI ZİLİ - SİYAH 32 MELODİ	1	10	36,50 \$



Ürün Kodu	Ürün Adı	Kutu Adet	Koli Adet	Fiyat (₺)
ZİLLER VE ZİL TRAFOLARI				
027 105 010012	ZİL TRAFOSU 12V	1 ad.	80	439,81
027 105 010015	ZİL TRAFOSU 15V	1 ad.	40	787,04
028 105 020003	KAMPANA ZİL 220V AC	1 ad.	24	2.037,04
028 105 020004	KAMPANA ZİL 12V AC, 24V AC, 110V AC	1 ad.	24	3.009,26
028 105 020000	MUNZAM ZİL ROLESİ	1 ad.	100	1.365,74
018 105 000006	KANARYA ZİL (TEK SES)	1 ad.	50	231,48
018 105 000007	KANARYA ZİL (ÜÇ SES)	1 ad.	50	254,63
018 105 000001	TELEFON ZİLİ (AYARLI)	1 ad.	50	393,52
018 105 000002	DİNG DONG ZİL ELEKTRONİK (3 SES)	1 ad.	50	296,30



Ürün Kodu	Ürün Adı	Kutu Adet	Koli Adet	Fiyat (₺)
KAPI VE MERDİVEN OTOMATIĞI				
027 112 000001	GİZLİ KAPI OTOMATIĞI (DOKUNMATİK)	1 ad.	20	1.759,26
027 112 000002	GİZLİ KAPI OTOMATIĞI (BASMATİK)	1 ad.	20	1.759,26
027 112 000007	ELEKTRİKLİ KİLİTLİ (ANAHTARLI) KAPI OTOMATIĞI	1 ad.	12	3.009,26
027 112 000009	ELEKTRİKLİ KİLİTLİ KAPI OTOMATIĞI (BİLYELİ)	1 ad.	12	3.009,26
027 112 000003	BUTONLU KAPI OTOMATIĞI	1 ad.	30	1.250,00
028 112 000004	KAPI OTOMATIĞI (NORMAL)	1 ad.	30	1.226,85
027 112 000004	BAS-AÇ KAPI OTOMATIĞI (TIRAJLI KİLİT İÇİN)	1 ad.	30	1.851,85
027 112 000005	MERDİVEN OTOMATIĞI (RAYLI)	1 ad.	30	1.226,85
027 112 000006	MERDİVEN OTOMATIĞI (NORMAL)	1 ad.	30	1.226,85



YANGIN ALGILAMA ve İKAZ SİSTEMLERİ

Ürün Kodu	Ürün Adı	Kutu Adet	Koli Adet	Fiyat (₺)
İKAZ KORNASI				
026 112 010001	İKAZ KORNASI 220V	1 ad.	45	902,78
028 120 000001	İKAZ BUTONU (KARE)	2 ad.	90	287,04
ALARM KORNA ve YANGIN İHBAR BUTONU				
010 090 050050	RESETLENEBİLİR BUTON	2 ad.	90	1.273,15
010 090 050051	RESETLENEBİLİR BUTON (KAPAKLI)	1 ad.	90	1.412,04
028 120 010006	ALARM KORNA PLASTİK	1 ad.	30	1.250,00
028 120 010005	ALARM KORNA DÖKÜM	1 ad.	30	1.435,19
SİRENLER				
102 111 000012	LEDLİ FLAŞÖRLÜ ELEKTRONİK SİREN 12V	1 ad.	25	638,89
102 111 000024	LEDLİ FLAŞÖRLÜ ELEKTRONİK SİREN 24V	1 ad.	25	638,89
102 111 000220	LEDLİ FLAŞÖRLÜ ELEKTRONİK SİREN 220V	1 ad.	25	671,30
102 111 000221	LEDLİ FLAŞÖRLÜ ELEKTRONİK SİREN 220V (YENİ MODEL)	1 ad.	30	925,93
888 111 050004	MS190 MİNİ SİREN (105 db)	1 ad.	40	15,50 \$
026 111 010001	AS.1 MOTORLU SİREN (PLASTİK GÖVDE) 220V, 100W (110 db.)	1 ad.	20	2.662,04
026 111 010002	AS.2 MOTORLU SİREN (PLASTİK GÖVDE) 220V, 100W (117 db.)	1 ad.	12	2.893,52
026 111 010003	AS.1 MOTORLU SİREN (METAL GÖVDE) 220V, 100W (115 db.)	1 ad.	20	3.125,00
026 111 010004	AS.2 MOTORLU SİREN (METAL GÖVDE) 220V, 100W (120 db.)	1 ad.	12	3.958,33
026 111 010005	AS.3 MOTORLU SİREN 220V-280W (130 db.)	1 ad.	-	26.157,41

KAPALI TİP BANYO ASPİRATÖRLERİ

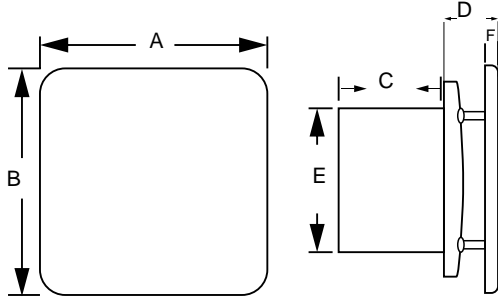

Ürün Kodu	Ürün Adı	Güç (W)	Emiş Hacmi (m ³ /h)	Devir hızı (rpm)	Ses (dB)	Ölçüler (mm)					Kutu /Koli Adet	Fiyat (₺)
						A	B	C	D	E		
001 211 100100 00 00	ME-FAN 100 KAPALI TİP ASPİRATÖR BEYAZ	12W	100 m ³ /h	2450 rpm	43 dB	180	180	60	35	100	1/20	816,67
001 211 100100 00 19	ME-FAN 100 KAPALI TİP ASPİRATÖR ANTRASİT	12W	100 m ³ /h	2450 rpm	43 dB	180	180	60	35	100	1/20	1.166,67
001 211 100120 00 00	ME-FAN 120 KAPALI TİP ASPİRATÖR BEYAZ	15W	120 m ³ /h	1900 rpm	47 dB	215	215	65	45	120	1/20	863,33
001 211 100120 00 19	ME-FAN 120 KAPALI TİP ASPİRATÖR ANTRASİT	15W	120 m ³ /h	1900 rpm	47 dB	215	215	65	45	120	1/20	1.353,33
001 211 100150 00 00	ME-FAN 150 KAPALI TİP ASPİRATÖR BEYAZ	20W	150 m ³ /h	1350 rpm	47 dB	260	260	80	40	150	1/12	1.213,33
001 211 100150 00 19	ME-FAN 150 KAPALI TİP ASPİRATÖR ANTRASİT	20W	150 m ³ /h	1350 rpm	47 dB	260	260	80	40	150	1/12	1.703,33

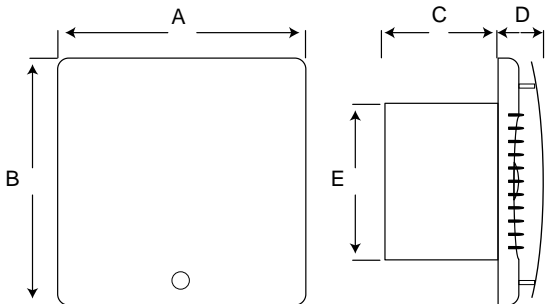

Ürün Kodu	Ürün Adı	Güç (W)	Emiş Hacmi (m ³ /h)	Devir hızı (rpm)	Ses (dB)	Ölçüler (mm)					Kutu /Koli Adet	Fiyat (₺)
						A	B	C	D	E		
001 111 100100 00 00	DEKORA 100 KAPALI TİP ASPİRATÖR	12W	100 m ³ /h	2450 rpm	43 dB	158	158	72	29	100	1/20	925,93

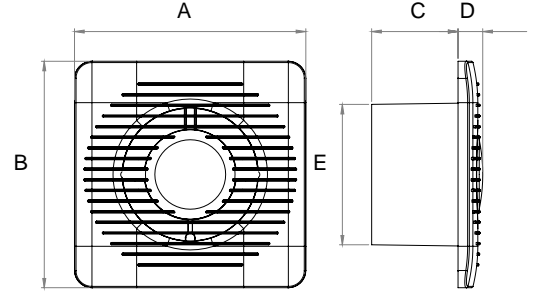

220-240V / 50-60Hz

ME-FAN BANYO ASPİRATÖLERİ

Ürün Kodu	Ürün Adı	Güç (W)	Emiş Hacmi (m ³ /h)	Devir hızı (rpm)	Ses (dB)	Ölçüler (mm)					Kutu /Koli Adet	Fiyat (₺)
						A	B	C	D	E		
001 211 000100 00 00	ME-FAN 100 ASPİRATÖR	12W	100 m ³ /h	2450 rpm	43 dB	158	158	60	17	100	1/20	686,00
001 211 000120 00 00	ME-FAN 120 ASPİRATÖR	15W	120 m ³ /h	1900 rpm	47 dB	180	180	65	20	120	1/20	714,00
001 211 000150 00 00	ME-FAN 150 ASPİRATÖR	20W	150 m ³ /h	1350 rpm	47 dB	222	222	80	22,5	150	1/12	1.073,33
001 211 000200 00 00	ME-FAN 200 ASPİRATÖR	40W	200 m ³ /h	1200 rpm	55 dB	260	260	90	13	200	1/6	1.726,67

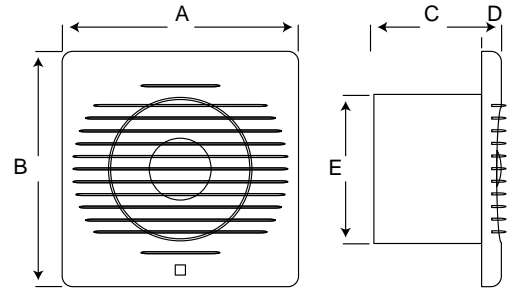

220-240V / 50-60Hz

MUTLUSAN BANYO ASPİRATÖLERİ

Ürün Kodu	Ürün Adı	Güç (W)	Emiş Hacmi (m ³ /h)	Devir hızı (rpm)	Ses (dB)	Ölçüler (mm)					Kutu /Koli Adet	Fiyat (₺)
						A	B	C	D	E		
001 111 000100 00 00	MUTLUSAN AIR 100 ASPİRATÖR	12W	100 m ³ /h	2450 rpm	43 dB	158	158	85	13	100	1/20	777,78
001 111 000120 00 00	MUTLUSAN AIR 120 ASPİRATÖR	15W	120 m ³ /h	1900 rpm	47 dB	175	175	85	13	120	1/20	814,81
001 111 000150 00 00	MUTLUSAN AIR 150 ASPİRATÖR	20W	150 m ³ /h	1350 rpm	47 dB	205	205	85	13	150	1/16	1.185,19
001 111 000200 00 00	MUTLUSAN AIR 200 ASPİRATÖR	40W	200 m ³ /h	1000 rpm	55 dB	260	260	90	13	200	1/6	2.037,04



Bluetooth™

Uzaktan Kumandalı



- 52cm pervane
- Düşük enerjili yüksek verimli motor
- İki yönlü fan çalışma özelliği
- Uzaktan kumanda
- 6 ayarlanabilir hız seçeneği
- Zaman ayarı
- Işık parlaklığı ve 3 renk ayarı
(beyaz - gün ışığı - soğuk beyaz)
- Bluetooth - müzik fonksiyonu
- Hoparlör
- LED aydınlatma

AYDINLATMALI TAVAN VANTİLATÖRÜ (BLUETOOTHLU)

Ürün Kodu	Ürün Adı	Kutu Adedi	Fiyat (₺)
001 038 300100 00 00	AYDINLATMALI TAVAN VANTİLATÖRÜ (BLUETOOTHLU) - BÜYÜK BOY - 52 cm	1	15.500,00

E

EXIT - ACİL AYDINLATMA ARMATÜRLERİ (LEDLİ) - IP20 CE



102 038 0008XX - CEXA

FİYAT : 986,11 ₺

- *GÖVDE : ABS
- *CAM : Polistren (PS) isteğe bağlı Akrilik(PMMA) veya Polycarbon(PC)
- *BASKI : Akrilik Işık geçirgen Translucent Folyo
- *ÇALIŞMA : Acil de ve Şebeke de sürekli çalışma
- *PİL : 3.6V 80mAH NİMH (NikelMethalhidrid)
- *ŞARJ SÜRESİ : 14-20 Saat
- *DEŞARJ SÜRESİ : 180 Dk
- *KORUMA SINIFI : IP20
- *LED : 4.8mm 6000K Beyaz Mantar Led
veya 2835 6400K EDİSON OPTO SMD Led
- TÜKETİM : 2 Watt

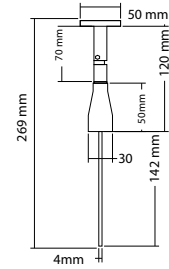
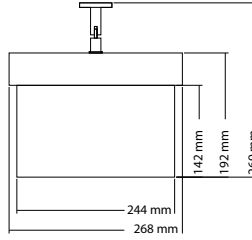

01	02	03	04	05	06	07	08
09	10	11	12	13	14		
15	16	17	18	19	20		
21	22	23	24	25	26		
27	28	29	30	31	32		
33	34	35	36				
37	38	39	40	41	42	43	
44	45	46	47	48	49	50	51
52	53	54	55	56	57	58	59
60	61	62	63	64	65		

*Sipariş Verdiğiniz Ürünün Sembol Kodunu Yazmayı Unutmayınız.

*Ürün Kodunun Son 2 hanesi olan XX Rakamları Ürünün Sembol Kodunu belirtmektedir.

LED ARMATÜR ÇEŞİTLERİ



Renk	BEYAZ	SİYAH
Ürün Kodu	016 038 701500	016 038 701511
Ürün Adı	LED GLOP ARMATÜR IP20	
Lümen/Watt	2000Lm/20W	
Kelvin	6400K	
Kutu/Koli Ad.	24	
Fiyat (₺)	607,64	



IP65

Ürün Kodu	016 038 701700	
Ürün Adı	18W NEMLİYER LED OVAL ARMATÜR - BEYAZ	
Lümen/Watt	1900Lm/18W	
Kelvin	6400K	
Kutu/Koli Ad.	1/40	
Fiyat (₺)	704,86	



IP65

Renk	BEYAZ	SİYAH
Ürün Kodu	016 038 701100	016 038 701111
Ürün Adı	LEDLIGHT-1 LEDLİ ARMATÜR	
Lümen/Watt	1500Lm/15W	
Kelvin	6400K	
Kutu/Koli Ad.	30	
Fiyat (₺)	351,85	



IP65

Renk	BEYAZ	SİYAH
Ürün Kodu	016 038 701300	016 038 701311
Ürün Adı	LEDLIGHT-3 LEDLİ ARMATÜR	
Lümen/Watt	1500Lm/15W	
Kelvin	6400K	
Kutu/Koli Ad.	30	
Fiyat (₺)	425,93	



Max: 26W



Ürün Kodu	016 038 250085	
Ürün Adı	ÇINAR DUVAR APLİK PLASTİK SOFT	
Kutu/Koli Ad.	1/24	
Fiyat (₺)	947,92	



IP65

Ürün Kodu	016 038 701522	
Ürün Adı	LED GLOP ARMATÜR KROM - IP20	
Lümen/Watt	2000Lm/20W	
Kelvin	6400K	
Kutu/Koli Ad.	24	
Fiyat (₺)	753,47	



Ürün Kodu	016 038 701600	
Ürün Adı	22W NEMLİYER LED GLOP ARM. - BEYAZ	
Lümen/Watt	2340Lm/22W	
Kelvin	6400K	
Kutu/Koli Ad.	1/40	
Fiyat (₺)	704,86	



IP65

Renk	BEYAZ	SİYAH
Ürün Kodu	016 038 701200	016 038 701211
Ürün Adı	LEDLIGHT-2 LEDLİ ARM.	
Lümen/Watt	2000Lm/20W	
Kelvin	6400K	
Kutu/Koli Ad.	20	
Fiyat (₺)	370,37	



IP65

Renk	BEYAZ	SİYAH
Ürün Kodu	016 038 701400	016 038 701411
Ürün Adı	LEDLIGHT-4 LEDLİ ARM.	
Lümen/Watt	2000Lm/20W	
Kelvin	6400K	
Kutu/Koli Ad.	20	
Fiyat (₺)	481,48	



Max: 26W



Ürün Kodu	078 039 500100	
Ürün Adı	SENSÖRLÜ DUVAR APLİK E-27 DUYLU	
Kutu/Koli Ad.	1/20	
Fiyat (₺)	947,92	



CE

Ürün Kodu	001 038 250026 00 00	
Ürün Adı	SENSÖRLÜ GLOP ARMATÜRÜ 2XE27 PLASTİK	
Kutu/Koli Ad.	1/12	
Fiyat (₺)	777,78	



CE

Ürün Kodu	001 038 250027 00 00	
Ürün Adı	SENSÖRLÜ GLOP ARMATÜRÜ LEDLİ PLASTİK	
Kutu/Koli Ad.	1/12	
Fiyat (₺)	1.186,11	



CE

Ürün Kodu	001 038 250022 00 00	
Ürün Adı	360° SENSÖRLÜ TAVAN ARMATÜRÜ (2x25W)	
Kutu/Koli Ad.	1/12	
Fiyat (₺)	991,67	

ARMATÜR ÇEŞİTLERİ



Renk	BEYAZ	SİYAH
Ürün Kodu	016 038 411110	016 038 411120
Ürün Adı	AQUA KAFESLİ APLİK - IP65	
Kutu/Koli Ad.	1/20	
Fiyat (₺)	402,78	



CE

Renk	BEYAZ	SİYAH
Ürün Kodu	016 038 700300	016 038 700311
Ürün Adı	DOLUNAY OPAK APLİK - IP54	
Kutu/Koli Ad.	1/20	
Fiyat (₺)	493,52	



CE

Renk	BEYAZ	SİYAH
Ürün Kodu	016 038 411300	016 038 411311
Ürün Adı	OPAK KAFESLİ ARMATÜR - IP54	
Kutu/Koli Ad.	1/24	
Fiyat (₺)	438,89	



Renk	BEYAZ	CEVİZ
Ürün Kodu	016 038 250088	016 038 250089
Ürün Adı	İNCİ APLİK - DUVAR ARMATÜR	
Kutu/Koli Ad.	4/64	
Fiyat (₺)	216,32	303,82



CE

Renk	BEYAZ	SİYAH
Ürün Kodu	016 038 700400	016 038 700411
Ürün Adı	DOLUNAY ŞEFFAF APLİK - IP54	
Kutu/Koli Ad.	1/20	
Fiyat (₺)	493,52	



CE

Renk	BEYAZ	SİYAH
Ürün Kodu	016 038 410600	016 038 410611
Ürün Adı	ELİPS OPAK ARMATÜR - IP65	
Kutu/Koli Ad.	1/10	
Fiyat (₺)	740,74	



CE

Renk	BEYAZ	SİYAH
Ürün Kodu	016 038 410500	016 038 410511
Ürün Adı	OPAK ARMATÜR - IP65	
Kutu/Koli Ad.	1/10	
Fiyat (₺)	718,98	



CE

Renk	BEYAZ	SİYAH
Ürün Kodu	016 038 410800	016 038 410811
Ürün Adı	OPAK ARMATÜR - IP65	
Kutu/Koli Ad.	1/16	
Fiyat (₺)	510,65	



Ürün Kodu	078 039 100005
Ürün Adı	NERGİS APLİK
Kutu/Koli Ad.	8/64
Fiyat (₺)	216,32



Renk	BEYAZ	CEVİZ
Ürün Kodu	016 038 250086	016 038 250087
Ürün Adı	İNCİ TAVAN ARMATÜR	
Kutu/Koli Ad.	4/32	
Fiyat (₺)	325,69	408,33



CE

Ürün Kodu	078 039 100006
Ürün Adı	ÇİFT DUYULU TAVAN ARMATÜR - IP20
Kutu/Koli Ad.	2/32
Fiyat (₺)	420,49



CE

Boyut	KÜÇÜK	BÜYÜK
Ürün Kodu	001 038 250016 00 00	001 038 250017 00 00
Ürün Adı	PAPATYA HAZIR ASKI TİJ TAKIMI	
Kutu/Koli Ad.	25/275	10/80
Fiyat (₺)	92,59	138,89



CE

Ürün Kodu	001 038 250018 00 00
Ürün Adı	HAZIR ASKI TİJ TAKIMI
Kutu/Koli Ad.	25/300
Fiyat (₺)	92,59



CE

Ürün Kodu	024 109 010005
Ürün Adı	YAĞMUR DUY (PLASTİK YANMAZ) E27
Kutu/Koli Ad.	50
Fiyat (₺)	60,76

APLİK ÇEŞİTLERİ



CE

Ürün Adı	ZETA 4'LÜ APLİK - IP64
Ürün Kodu	001 038 200102 00 11
Renk	3000K
Lümen/Watt	480Lm/4W
Kutu Adedi	1
Fiyat (\$)	10,00 \$



CE

Ürün Adı	ZETA 4'LÜ APLİK - IP64
Ürün Kodu	001 038 201102 00 11
Renk	2R+2B
Lümen/Watt	480Lm/4W
Kutu Adedi	1
Fiyat (\$)	10,00 \$



CE

Ürün Adı	ZETA 6'LI APLİK - IP64
Ürün Kodu	001 038 200103 00 11
Renk	3000K
Lümen/Watt	720Lm/6W
Kutu Adedi	1
Fiyat (\$)	10,67 \$



CE

Ürün Adı	ZETA 8'LI APLİK - IP64
Ürün Kodu	001 038 201104 00 11
Renk	2R+2G+2B+2Y
Lümen/Watt	960Lm/8W
Kutu Adedi	1
Fiyat (\$)	11,33 \$



CE

Ürün Adı	ZETA 8'LI APLİK - IP64
Ürün Kodu	001 038 200104 00 11
Renk	3000K
Lümen/Watt	960Lm/8W
Kutu Adedi	1
Fiyat (\$)	11,33 \$



CE

Ürün Adı	ZETA 10'LU APLİK - IP64
Ürün Kodu	001 038 201105 00 11
Renk	2R+2G+2B+2G+2R
Lümen/Watt	1200Lm/10W
Kutu Adedi	1
Fiyat (\$)	15,00 \$



CE

Ürün Adı	ZETA 10'LU APLİK - IP64
Ürün Kodu	001 038 200105 00 11
Renk	3000K
Lümen/Watt	1200Lm/10W
Kutu Adedi	1
Fiyat (\$)	15,00 \$



CE

Ürün Adı	HAPPY APLİK - IP64
Ürün Kodu	001 038 200124 00 11
Renk	3000K
Lümen/Watt	660Lm/6W
Kutu Adedi	1
Fiyat (\$)	12,77 \$



CE

Ürün Adı	KARE KÜÇÜK APLİK - IP44
Ürün Kodu	001 038 200108 00 11
Renk	3000K
Lümen/Watt	500Lm/5W
Kutu Adedi	1
Fiyat (\$)	11,00 \$



CE

Ürün Adı	KARE BÜYÜK APLİK - IP44
Ürün Kodu	001 038 200112 00 11
Renk	3000K
Lümen/Watt	1200Lm/12W
Kutu Adedi	1
Fiyat (\$)	19,33 \$



CE

Ürün Adı	MİNA APLİK - IP64
Ürün Kodu	001 038 200116 00 11
Renk	3000K
Lümen/Watt	1000Lm/10W
Kutu Adedi	1
Fiyat (\$)	11,00 \$



CE

Ürün Adı	MİLA APLİK - IP64
Ürün Kodu	001 038 200118 00 11
Renk	3000K
Lümen/Watt	1000Lm/10W
Kutu Adedi	1
Fiyat (\$)	19,33 \$

APLİK ÇEŞİTLERİ



CE

Ürün Adı	ALYA KÜÇÜK APLİK- IP44
Ürün Kodu	001 038 200110 00 11
Renk	3000K
Lümen/Watt	500Lm/5W
Kutu Adedi	1
Fiyat (\$)	11,00 \$



CE

Ürün Adı	ALYA BÜYÜK APLİK- IP44
Ürün Kodu	001 038 200114 00 11
Renk	3000K
Lümen/Watt	1200Lm/12W
Kutu Adedi	1
Fiyat (\$)	19,33 \$



CE

Ürün Adı	PERA APLİK - IP64
Ürün Kodu	001 038 200120 00 11
Renk	3000K
Lümen/Watt	660Lm/6W
Kutu Adedi	1
Fiyat (\$)	13,14 \$



CE

Ürün Adı	HERA APLİK - IP64
Ürün Kodu	001 038 200122 00 11
Renk	3000K
Lümen/Watt	660Lm/6W
Kutu Adedi	1
Fiyat (\$)	13,14 \$



Karanlığı Işıkla Buluşturur
SUNBOX Ledli Solar
Projektör

SOLAR BAHÇE APLİK ÇEŞİTLERİ



CE

Ürün Adı	ZETA 4'LÜ LEDLİ SOLAR APLİK - IP65
Ürün Kodu	016 038 200102
Renk	3000K
Lümen/Watt	60Lm/10W
Kutu Adedi	1/50
Fiyat (\$)	20,00 \$



CE

Ürün Adı	ZETA 6'LI LEDLİ SOLAR APLİK - IP65
Ürün Kodu	016 038 200104
Renk	3000K
Lümen/Watt	90Lm/15W
Kutu Adedi	1/50
Fiyat (\$)	28,33 \$



CE

Ürün Adı	VENUS LEDLİ SENSÖRLÜ SOLAR APLİK - IP65
Ürün Kodu	016 038 200106
Renk	3000K
Lümen/Watt	60Lm/10W
Kutu Adedi	1/80
Fiyat (\$)	18,33 \$



CE

Ürün Adı	MARS LEDLİ SOLAR BAHÇE ARMATÜRÜ - IP65
Ürün Kodu	016 038 200108
Renk	3000K
Lümen/Watt	40Lm/7W
Kutu Adedi	1/20
Fiyat (\$)	26,67 \$



CE

Ürün Adı	JUPİTER LEDLİ SOLAR BAHÇE ARMATÜRÜ - IP65
Ürün Kodu	016 038 200110
Renk	3000-4500K KUMANDALI
Lümen/Watt	380Lm/20W
Kutu Adedi	1/20
Fiyat (\$)	63,33 \$



CE

Ürün Adı	NEPTUNE LEDLİ SOLAR APLİK - IP65
Ürün Kodu	016 038 200112
Renk	3000-4500K KUMANDALI
Lümen/Watt	380Lm/20W
Kutu Adedi	1/20
Fiyat (\$)	38,11 \$



CE

Ürün Adı	SATURN LEDLİ SOLAR BAHÇE ARMATÜRÜ - IP65
Ürün Kodu	016 038 200114
Renk	3000-4500K KUMANDALI
Lümen/Watt	960Lm/50W
Kutu Adedi	1/6
Fiyat (\$)	89,91 \$



CE

Ürün Adı	SUNBOX LEDLİ SOLAR PROJKTÖR - IP65
Ürün Kodu	016 038 200116
Renk	W+R+B
Lümen/Watt	1420Lm/200W
Kutu Adedi	1/20
Fiyat (\$)	40,00 \$

BAHÇE AYDINLATMA



Ürün Adı	BURGAZ APLİK 28 CM - IP54
Ürün Kodu	016 038 710002
Duy	E27
Kutu/Koli Ad.	1/18
Fiyat (₺)	611,11



Ürün Adı	SEDEF APLİK 28 CM - IP54
Ürün Kodu	016 038 710006
Duy	E27
Kutu/Koli Ad.	1/20
Fiyat (₺)	611,11



Ürün Adı	ALİZE KÜP SET ÜSTÜ 27 CM - IP54
Ürün Kodu	016 038 710020
Duy	E27
Kutu/Koli Ad.	1/12
Fiyat (₺)	810,19



Ürün Adı	ERDEK APLİK 25 CM - IP54
Ürün Kodu	016 038 710010
Duy	E27
Kutu/Koli Ad.	1/18
Fiyat (₺)	611,11



Ürün Adı	MARMARA KÜP SET ÜSTÜ 27 CM - IP54
Ürün Kodu	016 038 710021
Duy	E27
Kutu/Koli Ad.	1/12
Fiyat (₺)	810,19



Ürün Adı	MARMARA APLİK 25 CM - IP54
Ürün Kodu	016 038 710014
Duy	E27
Kutu/Koli Ad.	1/20
Fiyat (₺)	638,89

BAHÇE ARMATÜRLERİ

Ürün Kodu	Ürün Adı	Ölçü	Kutu/Koli Ad.	Fiyat (₺)
016 038 710005	SEDEF SET ÜSTÜ - IP54 - E27 DUY	42 CM	1/16	611,11
016 038 710007	SEDEF BOLLARD - IP54 - E27 DUY	60 CM	1/12	839,12



Ürün Kodu	Ürün Adı	Ölçü	Kutu/Koli Ad.	Fiyat (₺)
016 038 710009	ERDEK SET ÜSTÜ - IP54 - E27 DUY	42 CM	1/18	611,11
016 038 710011	ERDEK BOLLARD - IP54 - E27 DUY	60 CM	1/12	839,12
016 038 710012	ERDEK BOLLARD - IP54 - E27 DUY	80 CM	1/12	1.070,60



Ürün Kodu	Ürün Adı	Ölçü	Kutu/Koli Ad.	Fiyat (₺)
016 038 710001	BURGAZ SET ÜSTÜ - IP54 - E27 DUY	42 CM	1/18	611,11
016 038 710003	BURGAZ BOLLARD - IP54 - E27 DUY	60 CM	1/12	839,12
016 038 710004	BURGAZ BOLLARD - IP54 - E27 DUY	80 CM	1/12	1.070,60



Ürün Kodu	Ürün Adı	Ölçü	Kutu/Koli Ad.	Fiyat (₺)
016 038 710013	MARMARA SET ÜSTÜ - IP54 - E27 DUY	42 CM	1/16	638,89
016 038 710015	MARMARA BOLLARD - IP54 - E27 DUY	60 CM	1/12	861,11
016 038 710016	MARMARA BOLLARD - IP54 - E27 DUY	80 CM	1/12	1.064,81



BAHÇE ARMATÜRLERİ



Ürün Kodu	Ürün Adı	Kutu/Koli Ad.	Fiyat (₺)
016 038 010116	FLORA BAHÇE ARMATÜRÜ - SİYAH	1/12	597,22
016 038 020116	FLORA BAHÇE ARMATÜRÜ - BEYAZ	1/12	597,22



Ürün Kodu	Ürün Adı	Kutu/Koli Ad.	Fiyat (₺)
016 038 010117	FLORA BAHÇE ARMATÜRÜ APLİK - SİYAH	1/12	597,22
016 038 020117	FLORA BAHÇE ARMATÜRÜ APLİK - BEYAZ	1/12	597,22



Ürün Kodu	Ürün Adı	Kutu/Koli Ad.	Fiyat (₺)
016 038 412011	FLORA BAHÇE ARMATÜRÜ TAVAN TİPİ - SİYAH	1/12	665,28
016 038 412000	FLORA BAHÇE ARMATÜRÜ TAVAN TİPİ - BEYAZ	1/12	665,28



Ürün Kodu	Ürün Adı	Kutu/Koli Ad.	Fiyat (₺)
016 038 412111	FLORA BAHÇE ARMATÜRÜ YARIM APLİK - SİYAH	1/20	494,44
016 038 412100	FLORA BAHÇE ARMATÜRÜ YARIM APLİK - BEYAZ	1/20	494,44

CE IP44



Ürün Kodu	Ürün Adı	Ölçü	Kutu/Koli Ad.	Fiyat (₺)
016 038 010120	GARDEN UZUN YER AYDINLATMA - SİYAH	542,3mm x Ø151,8	1/8	624,54
016 038 010118	GARDEN YER AYDINLATMA - SİYAH	327,5mm x Ø152	1/12	531,48
016 038 010122	GARDEN DUVAR AYDINLATMA - SİYAH	396mm	1/20	510,65

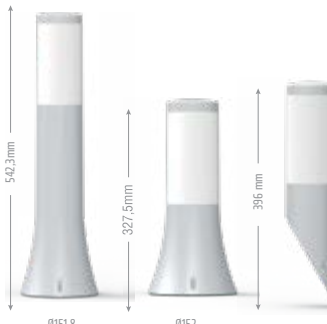

Ürün Kodu	Ürün Adı	Ölçü	Kutu/Koli Ad.	Fiyat (₺)
016 038 010121	GARDEN UZUN YER AYDINLATMA - GRİ	542,3mm x Ø151,8	1/8	624,54
016 038 010119	GARDEN YER AYDINLATMA - GRİ	327,5mm x Ø152	1/12	531,48
016 038 010123	GARDEN DUVAR AYDINLATMA - GRİ	396mm	1/20	510,65



Ürün Kodu	Ürün Adı	Kutu/Koli Ad.	Fiyat (₺)
016 038 010124	GARDEN APLİK - SİYAH	1/16	645,37
016 038 010125	GARDEN APLİK - GRİ	1/16	645,37

PANO ve ENDÜSTRİYEL ÜRÜN GRUBU



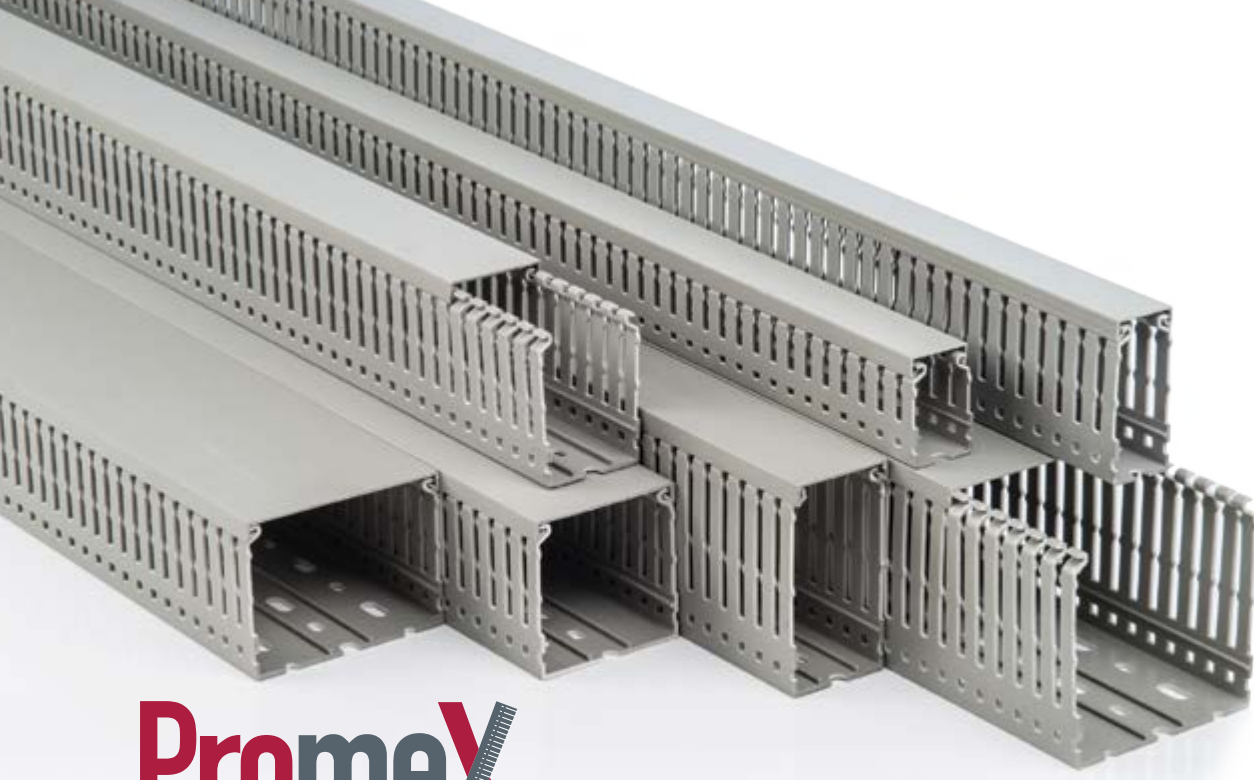

Promex

PANO TİPİ DELİKLİ KABLO KANALLARI



Kanal tırnakları tabanın üst noktasından, herhangi bir el aletine gereksinim duymadan 90 derecelik bükülme sonucu kolayca kırılabilir.

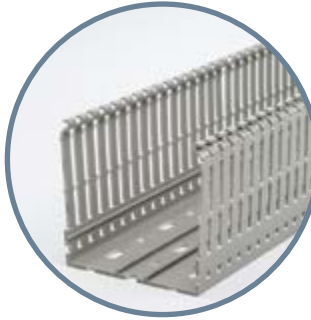

Özel tırnak tasarımı yapıları ile kablolarınızı sıkıştırabilirsiniz. Kanal içindeki kabloların, kablo bağı ile bağlanmasına imkan veren delikleri sayesinde daha düzenli ve hızlı kablolama imkanına sahip olursunuz.

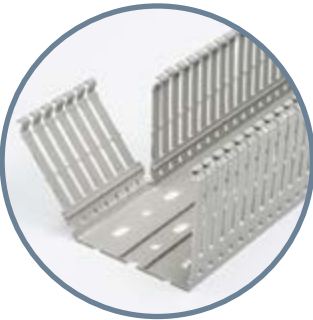

Kanal yan duvarı, kolay kırılma çizgileri sayesinde tabana sıfır olarak çıkarılabilir.



Özel kapak tasarımı, kanalın hangi konumda monte edildiğine bakılmaksızın kapağı kolayca monte etmemizi ve sökmemizi sağlar. Yoğun kablolamalarda bile kapağın kendinden çıkmasını engeller.

UL94-V0 alev iletmez özelliğe sahip PVC hammaddeden imal
Slot aralığı 4/6/4 + 5/8/5 mm genişliğinde
Taban montaj delikleri DIN 43659 standartına uygun
Standart kanal boyları 2mt
EN 50085-2-3 standartlarına uygun
Her türlü sevkiyat ve depolama koşullarına dayanıklı özel karton ambalaj
Standart renk RAL7030 Gri, istek üzerine diğer renkler üretilebilir
CE, RoHS sertifikalı

Ürün Kodu	Ölçü (mm)	Ürün Adı	Slot Aralığı (mm)	Ambalaj/Metre	Fiyat (₺)
PROMEX DELİKLİ KABLO KANALI					
001 110 025030 20 17	25x30	PROMEX DELİKLİ KABLO KANALI	4/6/4 mm	2m 112	118,89
001 110 025040 20 17	25x40	PROMEX DELİKLİ KABLO KANALI	4/6/4 mm	2m 96	120,37
001 110 025060 20 17	25x60	PROMEX DELİKLİ KABLO KANALI	4/6/4 mm	2m 60	155,56
001 110 025080 20 17	25x80	PROMEX DELİKLİ KABLO KANALI	4/6/4 mm	2m 64	196,68
001 110 040040 20 17	40x40	PROMEX DELİKLİ KABLO KANALI	4/6/4 mm	2m 56	150,97
001 110 040060 20 17	40x60	PROMEX DELİKLİ KABLO KANALI	4/6/4 mm	2m 40	179,24
001 110 040080 20 17	40x80	PROMEX DELİKLİ KABLO KANALI	4/6/4 mm	2m 40	233,37
001 110 040100 20 17	40x100	PROMEX DELİKLİ KABLO KANALI	5/8/5 mm	2m 32	282,70
001 110 060040 20 17	60x40	PROMEX DELİKLİ KABLO KANALI	4/6/4 mm	2m 36	204,50
001 110 060060 20 17	60x60	PROMEX DELİKLİ KABLO KANALI	4/6/4 mm	2m 24	245,40
001 110 060080 20 17	60x80	PROMEX DELİKLİ KABLO KANALI	4/6/4 mm	2m 32	303,15
001 110 060100 20 17	60x100	PROMEX DELİKLİ KABLO KANALI	5/8/5 mm	2m 32	326,00
001 110 080060 20 17	80x60	PROMEX DELİKLİ KABLO KANALI	4/6/4 mm	2m 24	292,32
001 110 080080 20 17	80x80	PROMEX DELİKLİ KABLO KANALI	4/6/4 mm	2m 24	359,69
001 110 080100 20 17	80x100	PROMEX DELİKLİ KABLO KANALI	5/8/5 mm	2m 24	508,14
001 110 100060 20 17	100x60	PROMEX DELİKLİ KABLO KANALI	4/6/4 mm	2m 20	363,28
001 110 100080 20 17	100x80	PROMEX DELİKLİ KABLO KANALI	4/6/4 mm	2m 12	381,68
001 110 100100 20 17	100x100	PROMEX DELİKLİ KABLO KANALI	5/8/5 mm	2m 16	588,61
001 110 120060 20 17	120x60	PROMEX DELİKLİ KABLO KANALI	4/6/4 mm	2m 20	409,01
001 110 120080 20 17	120x80	PROMEX DELİKLİ KABLO KANALI	4/6/4 mm	2m 16	523,08

PROMEX KABLO KANALI KAPAKLARI

001 016 100025 20 17	25'LİK	PROMEX KAPAK		50	37,04
001 016 100040 20 17	40'LİK	PROMEX KAPAK		50	48,15
001 016 100060 20 17	60'LİK	PROMEX KAPAK		50	72,22
001 016 100080 20 17	80'LİK	PROMEX KAPAK		50	88,89
001 016 100100 20 17	100'LÜK	PROMEX KAPAK		50	103,70
001 016 100120 20 17	120'LİK	PROMEX KAPAK		50	127,78



Promex
PANO TİPİ
DELİKLİ KABLO KANALLARI

XX : 10 1mt. delikli kablo kanalı için.
XX : 20 2mt. delikli kablo kanalı için.

Ürün Kodu	Ölçü (mm)	Ürün Adı	Ambalaj Koli - 1 m	Ambalaj Koli - 2 m	Fiyat (₺)
-----------	-----------	----------	--------------------	--------------------	-----------

PANO İÇİN MEKS DELİKLİ KABLO KANALLAR (GRİ)

001 005 025025 XX 17	25x25	MEKS DELİKLİ KABLO KANALI(GRİ)	1m 64	2m 120	94,44
001 005 025040 XX 17	25x40	MEKS DELİKLİ KABLO KANALI(GRİ)	1m 40	2m 80	116,67
001 005 025060 XX 17	25x60	MEKS DELİKLİ KABLO KANALI(GRİ)	1m 36	2m 80	148,15
001 005 040040 XX 17	40x40	MEKS DELİKLİ KABLO KANALI(GRİ)	1m 25	2m 50	148,15
001 005 040060 XX 17	40x60	MEKS DELİKLİ KABLO KANALI(GRİ)	1m 24	2m 48	177,78
001 005 060040 XX 17	60x40	MEKS DELİKLİ KABLO KANALI(GRİ)	1m 24	2m 48	203,70
001 005 060060 XX 17	60x60	MEKS DELİKLİ KABLO KANALI(GRİ)	1m 16	2m 32	245,00
001 005 060080 XX 17	60x80	MEKS DELİKLİ KABLO KANALI(GRİ)	1m 12	2m 24	298,15
001 005 060100 XX 17	60x100	MEKS DELİKLİ KABLO KANALI(GRİ)	1m 8	2m 16	326,48
001 005 040080 XX 17	40x80	MEKS DELİKLİ KABLO KANALI(GRİ)	1m 18	2m 36	233,33
001 005 080060 XX 17	80x60	MEKS DELİKLİ KABLO KANALI(GRİ)	1m 12	2m 24	285,18
001 005 100060 XX 17	100x60	MEKS DELİKLİ KABLO KANALI(GRİ)	1m 8	2m 16	359,26
001 005 100100 XX 17	100x100	MEKS DELİKLİ KABLO KANALI(GRİ)	1m 4	2m 8	585,19

PANO İÇİN MEKS DELİKLİ KABLO KANALLAR (MAVİ)

001 005 025025 XX 13	25x25	MEKS DELİKLİ KABLO KANALI(MAVİ)	1m 64	2m 120	96,21
001 005 025040 XX 13	25x40	MEKS DELİKLİ KABLO KANALI(MAVİ)	1m 40	2m 80	125,00
001 005 025060 XX 13	25x60	MEKS DELİKLİ KABLO KANALI(MAVİ)	1m 36	2m 80	168,52
001 005 040040 XX 13	40x40	MEKS DELİKLİ KABLO KANALI(MAVİ)	1m 25	2m 50	159,26
001 005 040060 XX 13	40x60	MEKS DELİKLİ KABLO KANALI(MAVİ)	1m 24	2m 48	192,59
001 005 060040 XX 13	60x40	MEKS DELİKLİ KABLO KANALI(MAVİ)	1m 24	2m 48	216,11
001 005 060060 XX 13	60x60	MEKS DELİKLİ KABLO KANALI(MAVİ)	1m 16	2m 32	265,37
001 005 060080 XX 13	60x80	MEKS DELİKLİ KABLO KANALI (MAVİ)	1m 12	2m 24	326,48
001 005 060100 XX 13	60x100	MEKS DELİKLİ KABLO KANALI (MAVİ)	1m 8	2m 16	360,07
001 005 040080 XX 13	40x80	MEKS DELİKLİ KABLO KANALI(MAVİ)	1m 18	2m 36	279,13
001 005 080060 XX 13	80x60	MEKS DELİKLİ KABLO KANALI(MAVİ)	1m 12	2m 24	333,82
001 005 100060 XX 13	100x60	MEKS DELİKLİ KABLO KANALI(MAVİ)	1m 8	2m 16	441,81
001 005 100100 XX 13	100x100	MEKS DELİKLİ KABLO KANALI(MAVİ)	1m 4	2m 8	674,07

YAPIŞKAN BANTLI MEKS DELİKLİ KABLO KANALLAR (GRİ)

001 008 025025 XX 17	25x25	MEKS DELİKLİ KABLO KANALI(YPŞK. BANTLI)(GRİ)	1m 64	2m 120	101,52
001 008 025040 XX 17	25x40	MEKS DELİKLİ KABLO KANALI(YPŞK. BANTLI)(GRİ)	1m 40	2m 80	128,79
001 008 025060 XX 17	25x60	MEKS DELİKLİ KABLO KANALI(YPŞK. BANTLI)(GRİ)	1m 36	2m 80	171,24
001 008 040040 XX 17	40x40	MEKS DELİKLİ KABLO KANALI(YPŞK. BANTLI)(GRİ)	1m 25	2m 50	161,78
001 008 040060 XX 17	40x60	MEKS DELİKLİ KABLO KANALI(YPŞK. BANTLI)(GRİ)	1m 24	2m 48	196,85
001 008 060040 XX 17	60x40	MEKS DELİKLİ KABLO KANALI(YPŞK. BANTLI)(GRİ)	1m 24	2m 48	216,31
001 008 060060 XX 17	60x60	MEKS DELİKLİ KABLO KANALI(YPŞK. BANTLI)(GRİ)	1m 16	2m 32	270,37
001 008 060080 XX 17	60x80	MEKS DELİKLİ KABLO KANALI(YPŞK. BANTLI)(GRİ)	1m 12	2m 24	329,63
001 008 060100 XX 17	60x100	MEKS DELİKLİ KABLO KANALI(YPŞK. BANTLI)(GRİ)	1m 8	2m 16	364,89
001 008 040080 XX 17	40x80	MEKS DELİKLİ KABLO KANALI(YPŞK. BANTLI)(GRİ)	1m 18	2m 36	296,30
001 008 080060 XX 17	80x60	MEKS DELİKLİ KABLO KANALI(YPŞK. BANTLI)(GRİ)	1m 12	2m 24	339,06
001 008 100060 XX 17	100x60	MEKS DELİKLİ KABLO KANALI(YPŞK. BANTLI)(GRİ)	1m 8	2m 16	448,31
001 008 100100 XX 17	100x100	MEKS DELİKLİ KABLO KANALI(YPŞK. BANTLI)(GRİ)	1m 4	2m 8	668,73

YAPIŞKAN BANTLI MEKS DELİKLİ KABLO KANALLAR (MAVİ)

001 008 025025 XX 13	25x25	MEKS DELİKLİ KABLO KANALI(YPŞK. BANTLI)(MAVİ)	1m 64	2m 120	106,36
001 008 025040 XX 13	25x40	MEKS DELİKLİ KABLO KANALI(YPŞK. BANTLI)(MAVİ)	1m 40	2m 80	136,43
001 008 025060 XX 13	25x60	MEKS DELİKLİ KABLO KANALI(YPŞK. BANTLI)(MAVİ)	1m 36	2m 80	188,38
001 008 040040 XX 13	40x40	MEKS DELİKLİ KABLO KANALI(YPŞK. BANTLI)(MAVİ)	1m 25	2m 50	172,73
001 008 040060 XX 13	40x60	MEKS DELİKLİ KABLO KANALI(YPŞK. BANTLI)(MAVİ)	1m 24	2m 48	222,22
001 008 060040 XX 13	60x40	MEKS DELİKLİ KABLO KANALI(YPŞK. BANTLI)(MAVİ)	1m 24	2m 48	230,44
001 008 060060 XX 13	60x60	MEKS DELİKLİ KABLO KANALI(YPŞK. BANTLI)(MAVİ)	1m 16	2m 32	292,59
001 008 060080 XX 13	60x80	MEKS DELİKLİ KABLO KANALI(YPŞK. BANTLI)(MAVİ)	1m 12	2m 24	362,96
001 008 060100 XX 13	60x100	MEKS DELİKLİ KABLO KANALI(YPŞK. BANTLI)(MAVİ)	1m 8	2m 16	396,30
001 008 040080 XX 13	40x80	MEKS DELİKLİ KABLO KANALI(YPŞK. BANTLI)(MAVİ)	1m 18	2m 36	343,99
001 008 080060 XX 13	80x60	MEKS DELİKLİ KABLO KANALI(YPŞK. BANTLI)(MAVİ)	1m 12	2m 24	405,68
001 008 100060 XX 13	100x60	MEKS DELİKLİ KABLO KANALI(YPŞK. BANTLI)(MAVİ)	1m 8	2m 16	519,40
001 008 100100 XX 13	100x100	MEKS DELİKLİ KABLO KANALI(YPŞK. BANTLI)(MAVİ)	1m 4	2m 8	746,08

Ürün Kodu	Ölçü (mm)	Ürün Adı	Kutu Adedi	Fiyat (₺)
-----------	-----------	----------	------------	-----------

KABLO TUTUCU APARATI

001 050 010001 00 00	25x40	KABLO TUTUCU APARATI	50	57,41
001 050 010002 00 00	40x40	KABLO TUTUCU APARATI	50	57,41
001 050 010003 00 00	60x40	KABLO TUTUCU APARATI	50	57,41

KABLO TUTUCU YAN APARATI

001 050 020001 00 00	40x40/60	KABLO TUTUCU YAN APARATI	100	21,30
001 050 020002 00 00	60x40/60	KABLO TUTUCU YAN APARATI	100	21,30
001 050 020004 00 00	100x60	KABLO TUTUCU YAN APARATI	100	33,33

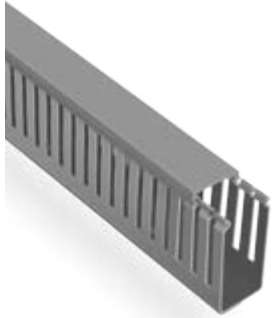
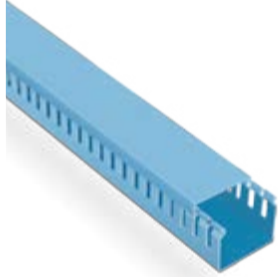
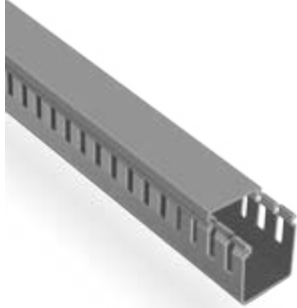

MEKSPUS⁺

PANO



ZORLU ŞARTLAR İÇİN
MAKSİMUM KORUMA

MEKSPUS OPAK KAPAKLI ABS PANOLAR

Ürün Kodu	Ölçü (cm)	Ürün Adı	Ağırlık (kg)	Adet	Fiyat (₺)
048 096 203013	20X30X13	MEKSPUS PLASTİK OPAK KAPAKLI PANO IP67	1.64	1	1.566,04
048 096 253515	25X35X15	MEKSPUS PLASTİK OPAK KAPAKLI PANO IP67	2.29	1	2.056,71
048 096 304017	30X40X17	MEKSPUS PLASTİK OPAK KAPAKLI PANO IP67	3.13	1	2.547,38
048 096 405018	40X50X17,5	MEKSPUS PLASTİK OPAK KAPAKLI PANO IP67	4.90	1	3.735,20
048 096 405024	40X50X24	MEKSPUS PLASTİK OPAK KAPAKLI PANO IP67	5.52	1	4.287,20
048 096 406020	40X60X20	MEKSPUS PLASTİK OPAK KAPAKLI PANO IP67	6.30	1	4.321,96



MEKSPUS ŞEFFAF KAPAKLI ABS PANOLAR

Ürün Kodu	Ölçü (cm)	Ürün Adı	Ağırlık (kg)	Adet	Fiyat (₺)
048 097 203013	20X30X13	MEKSPUS PLASTİK ŞEFFAF KAPAKLI PANO IP67	1.68	1	1.772,80
048 097 253515	25X35X15	MEKSPUS PLASTİK ŞEFFAF KAPAKLI PANO IP67	2.29	1	2.284,80
048 097 304017	30X40X17	MEKSPUS PLASTİK ŞEFFAF KAPAKLI PANO IP67	3.13	1	2.779,73
048 097 405018	40X50X17,5	MEKSPUS PLASTİK ŞEFFAF KAPAKLI PANO IP67	5.06	1	4.428,80
048 097 405024	40X50X24	MEKSPUS PLASTİK ŞEFFAF KAPAKLI PANO IP67	5.57	1	5.041,07
048 097 406020	40X60X20	MEKSPUS PLASTİK ŞEFFAF KAPAKLI PANO IP67	6.37	1	5.179,73



PromexPANO



PROMEX OPAK KAPAKLI ABS PANOLAR - HALOGEN FREE

Ürün Kodu	Ölçü (cm)	Ürün Adı	Ağırlık (kg)	Adet	Fiyat (₺)
001 046 203013 00 17	20x30x13	PROMEX PLASTİK OPAK KAPAKLI PANO	1,70	1	1.111,11
001 046 253515 00 17	25x35x15	PROMEX PLASTİK OPAK KAPAKLI PANO	2,20	1	1.574,07
001 046 304017 00 17	30x40x17	PROMEX PLASTİK OPAK KAPAKLI PANO	3,00	1	1.814,81
001 046 304022 00 17	30x40x22	PROMEX PLASTİK OPAK KAPAKLI PANO	3,40	1	2.222,22
001 046 355019 00 17	35x50x19	PROMEX PLASTİK OPAK KAPAKLI PANO	4,30	1	2.629,63
001 046 405018 00 17	40x50x18	PROMEX PLASTİK OPAK KAPAKLI PANO	4,30	1	2.777,78
001 046 405024 00 17	40x50x24	PROMEX PLASTİK OPAK KAPAKLI PANO	5,60	1	3.259,26
001 046 406020 00 17	40x60x20	PROMEX PLASTİK OPAK KAPAKLI PANO	6,00	1	3.407,41
001 046 507025 00 17	50x70x25	PROMEX PLASTİK OPAK KAPAKLI PANO	10,10	1	5.370,37
001 046 608026 00 17	60x80x26	PROMEX PLASTİK OPAK KAPAKLI PANO	13,50	1	8.703,70

PROMEX ŞEFFAF KAPAKLI ABS PANOLAR - HALOGEN FREE

Ürün Kodu	Ölçü (cm)	Ürün Adı	Ağırlık (kg)	Adet	Fiyat (₺)
001 046 203013 00 44	20x30x13	PROMEX PLASTİK ŞEFFAF KAPAKLI PANO	1,70	1	1.148,15
001 046 253515 00 44	25x35x15	PROMEX PLASTİK ŞEFFAF KAPAKLI PANO	2,20	1	1.666,67
001 046 304017 00 44	30x40x17	PROMEX PLASTİK ŞEFFAF KAPAKLI PANO	3,00	1	2.074,07
001 046 304022 00 44	30x40x22	PROMEX PLASTİK ŞEFFAF KAPAKLI PANO	3,40	1	2.508,48
001 046 355019 00 44	35x50x19	PROMEX PLASTİK ŞEFFAF KAPAKLI PANO	4,30	1	3.146,83
001 046 405018 00 44	40x50x18	PROMEX PLASTİK ŞEFFAF KAPAKLI PANO	4,30	1	3.323,81
001 046 405024 00 44	40x50x24	PROMEX PLASTİK ŞEFFAF KAPAKLI PANO	5,60	1	3.962,73
001 046 406020 00 44	40x60x20	PROMEX PLASTİK ŞEFFAF KAPAKLI PANO	6,00	1	3.963,32
001 046 507025 00 44	50x70x25	PROMEX PLASTİK ŞEFFAF KAPAKLI PANO	10,10	1	6.433,69
001 046 608026 00 44	60x80x26	PROMEX PLASTİK ŞEFFAF KAPAKLI PANO	13,50	1	10.050,79



IP65 CE

PROMEX OPAK KAPAKLI ABS OTOMAT PANOLAR - HALOGEN FREE

Ürün Kodu	Ölçü (cm)	Ürün Adı	Ağırlık (kg)	Adet	Fiyat (₺)
001 046 253515 01 17	25x35x15	PROMEX 18 OTOMATLI (9x2)	2,50	1	3.084,22
001 046 304017 01 17	30x40x17	PROMEX 24 OTOMATLI (12x2)	3,40	1	3.529,61
001 046 355019 01 17	35x50x19	PROMEX 45 OTOMATLI (15x3)	4,50	1	4.739,29
001 046 406020 01 17	40x60x20	PROMEX 60 OTOMATLI (15x4)	6,00	1	5.609,65



IP65 CE

PROMEX ŞEFFAF KAPAKLI ABS OTOMAT PANOLAR - HALOGEN FREE

Ürün Kodu	Ölçü (cm)	Ürün Adı	Ağırlık (kg)	Adet	Fiyat (₺)
001 046 253515 01 44	25x35x15	PROMEX 18 OTOMATLI (9x2)	2,50	1	3.114,49
001 046 304017 01 44	30x40x17	PROMEX 24 OTOMATLI (12x2)	3,40	1	3.553,70
001 046 355019 01 44	35x50x19	PROMEX 45 OTOMATLI (15x3)	4,50	1	4.789,93
001 046 406020 01 44	40x60x20	PROMEX 60 OTOMATLI (15x4)	6,00	1	5.964,64



GALVANİZ TABAN SAÇLARI

Ürün Kodu	Ölçü (cm)	Ürün Adı	Adet	Fiyat (₺)
000 702 203013 00 00	20x30x13	GALVANİZ TABAN SAÇI 1mm	1	227,61
000 702 253515 00 00	25x35x15	GALVANİZ TABAN SAÇI 1mm	1	253,35
000 702 304017 00 00	30x40x17	GALVANİZ TABAN SAÇI 1mm	1	330,04
000 702 304022 00 00	30x40x22	GALVANİZ TABAN SAÇI 1mm	1	338,81
000 702 355019 00 00	35x50x19	GALVANİZ TABAN SAÇI 1mm	1	478,80
000 702 405018 00 00	40x50x17,5	GALVANİZ TABAN SAÇI 1mm	1	571,90
000 702 405024 00 00	40x50x24	GALVANİZ TABAN SAÇI 1mm	1	559,33
000 702 406020 00 00	40x60x20	GALVANİZ TABAN SAÇI 1mm	1	680,90
000 702 507025 00 00	50x70x25	GALVANİZ TABAN SAÇI 1mm	1	971,54



MODÜLER KİTLER ve SEPERATÖRLER

Ürün Kodu	Ölçü (cm)	Ürün Adı	Adet	Fiyat (₺)
000 700 253515 01 17	25X35X15	18 OTOMATLI (9X2)	1	1.860,91
000 700 304017 01 17	30X40X17	24 OTOMATLI (12X2)	1	2.154,73
000 700 355019 01 17	35X50X19	45 OTOMATLI (15X3)	1	2.938,27
000 700 406020 01 17	40X60X20	60 OTOMATLI (15X4)	1	3.036,22
000 700 253515 00 17	25X35X15	PLASTİK PERDE	1	259,26
000 700 304017 00 17	30X40X17	PLASTİK PERDE	1	333,33
000 700 355019 00 17	35X50X19	PLASTİK PERDE	1	555,56
000 700 406020 00 17	40X60X20	PLASTİK PERDE	1	592,59



000 705 000720 00 00



000 700 000710 00 17



000 700 000711 00 17



000 700 000712 00 17



000 705 000721 00 00

PANO AKSESUARLARI

Ürün Kodu	Ürün Adı	Adet	Fiyat (₺)
000 705 000720 00 00	PANO KİLİT GÖBEK TAKIMI (SET)	1	96,30
000 700 000710 00 17	PANO DUVAR MONTAJ APARATI	1	37,04
000 700 000711 00 17	PANO ÜÇGEN ANAHTAR	1	37,04
000 700 000712 00 17	PANO SEPERATÖRÜ TUTTURMA VİDASI	1	55,56
000 705 000721 00 00	PLASTİK KİLİTLENEBİLİR PANO (METAL) KİLİDİ	1	1.018,52

YENİ

SAYAÇ
PANOLARIŞantiyeler için güçlü,
düzenli ve güvenli enerji çözümü...

Zorlu şantiye koşulları için özel olarak tasarlanan elektrik panolarımız, taban sacı ile güçlendirilmiş yapısı sayesinde maksimum dayanıklılık ve güvenli montaj imkânı sağlar...

Sayaç panosu; şalt ekipmanların daha sağlam, düzgün ve güvenli şekilde montajını sağlarken, saha uygulamalarında büyük kolaylık oluşturur.

Toza, darbeye ve dış etkenlere karşı dayanıklı gövdesiyle uzun ömürlü kullanım sunan panolarımız; hızlı kurulum, güvenli enerji dağıtımı ve şantiye ortamlarına tam uyum sağlar.



IP65 CE

SAYAÇ PANOLARI - OPAK KAPAKLI

Ürün Kodu	Ölçü (cm)	Ürün Adı	Adet	Fiyat (₺)
999 999 005302	30x50x19	1'Lİ TRİFAZE SAYAÇ PANOSU (10 Sigorta)	1	3.632,79
999 999 005303	40x60x20	1'Lİ TRİFAZE SAYAÇ PANOSU (24 Sigorta)	1	5.485,51

Ray Tipi Pano Prizleri

Rayında Giden
Güvenlik!



RAY TİPİ PANO PRİZLERİ

Ürün Kodu 010 104 000157

Ürün Adı MRP-16 1x16 RAY TİPİ PANO PRİZİ

Koli Adedi 10

Fiyat (₺) 208,06



Ürün Kodu 010 104 000158

Ürün Adı MRP-LED 1x16 RAY TİPİ PANO PRİZİ - LEDLİ

Koli Adedi 10

Fiyat (₺) 307,13



Ürün Kodu 010 104 000159

Ürün Adı MRP-UPS 1X16 RAY TİPİ PANO PRİZİ - UPS

Koli Adedi 10

Fiyat (₺) 307,13

PROMEX SERİSİ

TERMOSTAT ve HİGROSTAT

EKOFAN SERİSİ

TERMOSTAT ve HİGROSTAT



ISITMA TERMOSTAT - NK

Ürün Kodu	048 095 000300
Ayar Sahası	0-60°C
Kontakt Tipi	NK
Koruma Sınıfı	IP20
Ağırlık	45 GR
Koli Adet	135
Fiyat (\$)	9,80 \$



SOĞUTUCU TERMOSTAT

Ürün Kodu	048 095 101141
Ayar Sahası	0-60°C
Kontakt Tipi	NO
Koruma Sınıfı	IP20
Ağırlık	45 GR
Koli Adet	1
Fiyat (\$)	6,79 \$



SOĞUTMA TERMOSTAT - NA

Ürün Kodu	048 095 000301
Ayar Sahası	0-60°C
Kontakt Tipi	NA
Koruma Sınıfı	IP20
Ağırlık	45 GR
Koli Adet	135
Fiyat (\$)	9,80 \$



MULTİ TERMOSTAT

Ürün Kodu	048 095 101142
Ayar Sahası	0-60°C / 0-60°C
Kontakt Tipi	NC+NO
Koruma Sınıfı	IP20
Ağırlık	80 GR
Koli Adet	1
Fiyat (\$)	23,43 \$



DUAL TERMOSTAT - NK+NA

Ürün Kodu	048 095 000302
Ayar Sahası	0-60°C / 0-60°C
Kontakt Tipi	NK+NA
Koruma Sınıfı	IP20
Ağırlık	80 GR
Koli Adet	60
Fiyat (\$)	19,59 \$



HİGROSTAT

Ürün Kodu	048 095 101143
Ayar Sahası	%40-90RH
Kontakt Tipi	1CO
Koruma Sınıfı	IP20
Ağırlık	180 GR
Koli Adet	1
Fiyat (\$)	70,28 \$



MEKANİK HİGROSTAT - 1CO

Ürün Kodu	048 095 000303
Ayar Sahası	%10-90RH
Kontakt Tipi	1CO
Koruma Sınıfı	IP20
Ağırlık	180 GR
Koli Adet	30
Fiyat (\$)	83,27 \$



ODA TERMOSTAT

Ürün Kodu	048 095 101144
Ayar Sahası	%10-90RH
Kontakt Tipi	1CO
Koruma Sınıfı	IP20
Ağırlık	180 GR
Koli Adet	1
Fiyat (\$)	74,96 \$



Teknik Veriler İçin
Okutunuz

PROMEX SERİSİ TEPE FANLARI



IP54



Poliüretan Conta



Radyal Fan

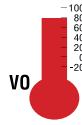

VO Alev İletmez ABS

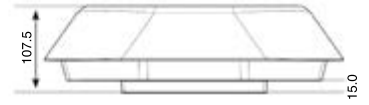
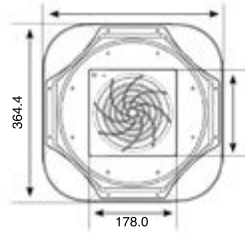

PROMEX TEPE FANLARI

Ürün Kodu	Fan Tipi	Besleme	Güç (W)	Nominal Akım	Gürültü Seviyesi	Kapasite	Adet	Fiyat (\$)
048 095 000100	Ø172x163x51 AKSİYEL	220V AC 50/60 Hz	25/32W	0,11/0,15A	57 dB	400 m ³ /h	1	81,48 \$
048 095 000101	Ø190x68 RADYAL	220V AC 50/60 Hz	58/75W	0,26/0,34A	62 dB	560 m ³ /h	1	162,96 \$
048 095 000102	Ø220X71 RADYAL	220V AC 50/60 Hz	85/90W	0,38/0,44A	73 dB	970 m ³ /h	1	183,33 \$



Vidasız hızlı ve kolay montaj !



IP54



Poliüretan Conta



Radyal Fan

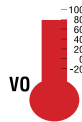

VO Alev İletmez ABS



Hızlı ve Kolay Montaj

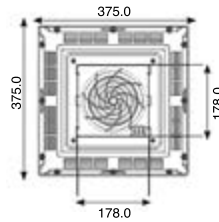

Ürün Kodu	Fan Tipi	Besleme	Güç (W)	Nominal Akım	Gürültü Seviyesi	Kapasite	Adet	Fiyat (\$)
048 095 000200	Ø172x163x51 AKSİYEL	220V AC 50/60 Hz	25/32W	0,11/0,15A	57 dB	400 m ³ /h	1	81,48 \$
048 095 000201	Ø190x68 RADYAL	220V AC 50/60 Hz	58/75W	0,26/0,34A	62 dB	560 m ³ /h	1	162,96 \$
048 095 000202	Ø220X71 RADYAL	220V AC 50/60 Hz	85/90W	0,38/0,44A	73 dB	970 m ³ /h	1	183,33 \$

EKOFAN SERİSİ TEPE FANLARI



EKOFAN TEPE FANLARI

Ürün Kodu	Fan Tipi	Besleme	Cüç (W)	Nominal Akım	Gürültü Seviyesi	Kapasite	Adet	Fiyat (\$)
048 095 100100	MTF300	230V AC 50/60 Hz	35W	0,15A	51 dB	300 m ³ /h	1	73,33 \$
048 095 100101	MTF 600	230V AC 50/60 Hz	65W	0,30A	60 dB	634 m ³ /h	1	146,67 \$
048 095 100102	MTF 900	230V AC 50/60 Hz	90W	0,48A	60 dB	900 m ³ /h	1	165,00 \$



KOLAY MONTAJ FİLTRELER

Ürün Kodu	Ölçü (mm)	Kesim Ölçüsü (mm)	Koruma Sınıfı	Adet / Koli	Fiyat (\$)
048 095 000400	120x120x20,5	92x92	IP54	200	4,69 \$
048 095 000401	160x160x31	125x125	IP54	100	7,96 \$
048 095 000402	210x210x31	177x177	IP54	100	11,71 \$
048 095 000403	260x260x31	223x223	IP54	100	16,40 \$
048 095 000404	325x325x31	291x291	IP54	100	32,80 \$



PROJE CEPLERİ

Ürün Kodu	Ürün Adı	Adet / Koli	Fiyat (\$)
048 095 000902	PROJE CEBİ A4	1	5,14 \$
048 095 000903	PROJE CEBİ A5	1	4,03 \$

FİLTRELİ FANLAR



048 095 000500



048 095 000501



048 095 000502

Ürün Kodu	048 095 000500	048 095 000501	048 095 000502
Ölçü (mm)	120x120x58,5	160x160x69	120x120x58,5
Kesim Ölçüsü (mm)	92x92	125x125	92x92
Fan Tipi	80x80x38	120x120x38	80x80x38
Besleme (VAC)	230V-50/60Hz	230V-50/60Hz	230V-50/60Hz
Güç (W)	14 (13)	26 (23)	14 (13)
Hız (Rpm)	2800	2700	2800
Filtreli (m ³ /H)	30	100	30
Filtresiz (m ³ /H)	41	140	41
Nominal Akım	0,08 / 0,07	0,14 / 0,13	0,8 / 0,7
Gürültü Seviyesi (Db)	28 (31)	42 (46)	28 (31)
Adet / Fiyat (\$)	28,11 \$	37,48 \$	42,17 \$



048 095 000600



048 095 000601



048 095 000602



048 095 000603

Ürün Kodu	048 095 000600	048 095 000601	048 095 000602	048 095 000603
Ölçü (mm)	160x160x69	210x210x98	210x210x83	260x260x103
Kesim Ölçüsü (mm)	125x125	177x177	177x177	223x223
Fan Tipi	120x120x38	120x120x38	173x163x51	120x120x38
Besleme (VAC)	230V-50/60Hz	230V-50/60Hz	230V-50/60Hz	230V-50/60Hz
Güç (W)	26 (23)	26 (23)	37 (35)	26 (23)
Hız (Rpm)	2700	2700	2400	2700
Filtreli (m ³ /h)	100	125	175	115
Filtresiz (m ³ /h)	140	175	245	130
Nominal Akım	0,14 / 0,13	0,14 / 0,13	0,23 / 0,22	0,14 / 0,13
Gürültü Seviyesi (Db)	42 (46)	42 (46)	52 (53)	42 (46)
Adet / Fiyat (\$)	46,85 \$	65,59 \$	83,33 \$	84,33 \$



048 095 000604



048 095 000605



048 095 000606



048 095 000607

Ürün Kodu	048 095 000604	048 095 000605	048 095 000606	048 095 000607
Ölçü (mm)	260x260x116	260x260x111	325x325x145	325x325x111
Kesim Ölçüsü (mm)	223x223	223x223	291x291	291x291
Fan Tipi	172x163x51	225x225x80	225x225x80	280x280x80
Besleme (VAC)	230V-50/60Hz	230V-50/60Hz	230V-50/60Hz	230V-50/60Hz
Güç (W)	37 (35)	66 (75)	66 (75)	110 (140)
Hız (Rpm)	2400	2600	2600	2600
Filtreli (m ³ /h)	240	650	700	850
Filtresiz (m ³ /h)	270	900	950	1200
Nominal Akım	0,23 / 0,22	0,35 / 0,38	0,35 / 0,38	0,50 / 0,72
Gürültü Seviyesi (Db)	52 (53)	60 (63)	60 (63)	65 (68)
Adet / Fiyat (\$)	93,70 \$	234,26 \$	257,69 \$	281,11 \$



MINİ ISITICI



PTC ISITICI



SLİM ISITICI

PANO ISITICILARI

Ürün Kodu	Ürün Adı	Besleme	Koruma Sınıfı	Ölçüler (AxBxC)mm	Bağlantı	Adet	Fiyat (\$)
048 095 000700	15W PTC PANO ISITICISI	100-250V AC-DC	IP20	60x50x27	KABLO	1	32,80 \$
048 095 000701	25W PTC PANO ISITICISI	100-250V AC-DC	IP20	70x50x27	KABLO	1	37,48 \$
048 095 000702	30W PTC PANO ISITICISI	100-250V AC-DC	IP20	128x70x59	KLEMENS	1	56,22 \$
048 095 000703	50W PTC PANO ISITICISI	100-250V AC-DC	IP20	138x70x59	KLEMENS	1	65,59 \$
048 095 000704	75W PTC PANO ISITICISI	100-250V AC-DC	IP20	178x70x59	KLEMENS	1	79,65 \$
048 095 000705	100W PTC PANO ISITICISI	100-250V AC-DC	IP20	188x70x59	KLEMENS	1	93,70 \$
048 095 000706	150W PTC PANO ISITICISI	100-250V AC-DC	IP20	228x70x59	KLEMENS	1	112,44 \$
048 095 000707	30W SLİM PTC PANO ISITICISI	100-250V AC-DC	IP20	128x27x80	KLEMENS	1	56,22 \$
048 095 000708	50W SLİM PTC PANO ISITICISI	100-250V AC-DC	IP20	138x27x80	KLEMENS	1	65,59 \$
048 095 000709	75W SLİM PTC PANO ISITICISI	100-250V AC-DC	IP20	178x27x80	KLEMENS	1	79,65 \$
048 095 000710	100W SLİM PTC PANO ISITICISI	100-250V AC-DC	IP20	188x27x80	KLEMENS	1	93,70 \$
048 095 000711	150W SLİM PTC PANO ISITICISI	100-250V AC-DC	IP20	228x27x80	KLEMENS	1	112,44 \$



FANLI PTC ISITICI



FANLI ISITICI



400W PLASTİK FANLI ISITICI

FANLI PANO ISITICILARI

Ürün Kodu	Ürün Adı	Besleme	Koruma Sınıfı	Ölçüler (AxBxC)mm	Bağlantı	Adet	Fiyat (\$)
048 095 000800	100W FANLI PTC PANO ISITICISI	230V AC 50/60 Hz	IP20	170x89x60	KLEMENS	1	187,41 \$
048 095 000801	150W FANLI PTC PANO ISITICISI	230V AC 50/60 Hz	IP20	210x89x60	KLEMENS	1	210,83 \$
048 095 000802	250W FANLI REZİSTANS PANO ISITICISI	230V AC 50/60 Hz	IP20	152x110x80	KLEMENS	1	234,26 \$
048 095 000803	500W FANLI REZİSTANS PANO ISITICISI	230V AC 50/60 Hz	IP20	182x110x80	KLEMENS	1	243,63 \$
048 095 000804	750W FANLI REZİSTANS PANO ISITICISI	230V AC 50/60 Hz	IP20	232x110x80	KLEMENS	1	281,11 \$
048 095 000805	200/300/400W FANLI PTC PANO ISITICISI	230V AC 50/60 Hz	IP20	99x70x67	KABLO	1	257,69 \$

- Titreşimli Alanlarda Mükemmel Bağlantı
- Aletsiz Kablolama
- Kompakt Boyut
- Kablolama Süresinden %75 Tasarruf
- Yüksek Çekme Kuvveti

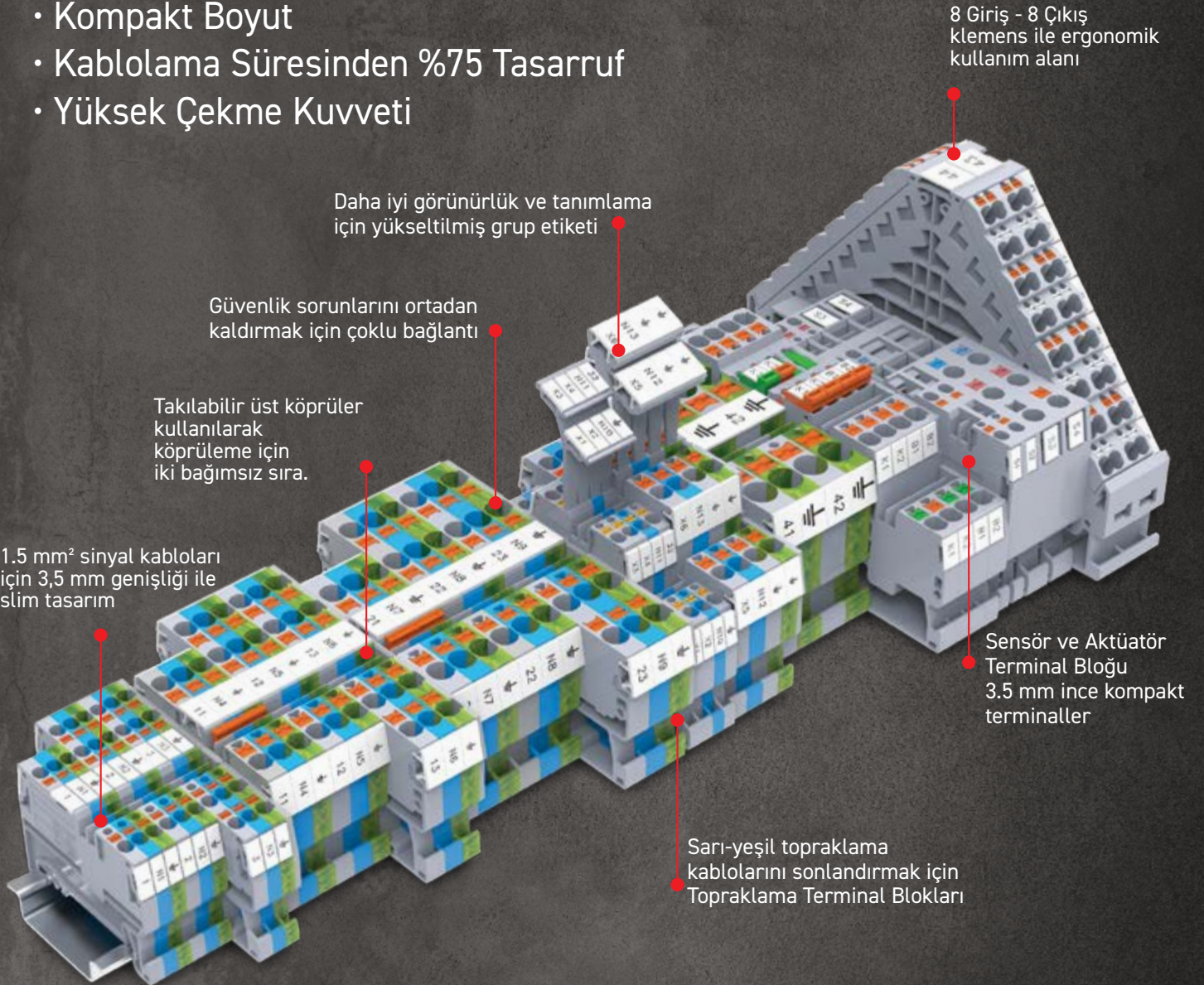

YENİ NESİL

Promex
PUSH-IN TİP
RAY KLEMENSLER

PROMEX SERİSİ PUSH-IN TİP RAY KLEMENSLER

	Ürün Kodu	Ürün Adı	Gerilim / Akım V/A	Kutu Adedi	Fiyat (\$)
	065 095 0XX015	MP1.5 1,5 mm Ray Klemens Push-In Tip	800V 15A	100	0,88 \$
	065 095 0XX025	MP2.5 2,5 mm Ray Klemens Push-In Tip	1000V 24A	100	0,91 \$
	065 095 0XX004	MP4 4 mm Ray Klemens Push-In Tip	1000V 32A	100	1,21 \$
	065 095 0XX010	MP6/10 6/10 mm Ray Klemens Push-In Tip	1000V 57A	100	2,56 \$
	065 095 417015	MP1.5/3 1,5 mm 1 Giriş 2 Çıkış Ray Klemens Push-In Tip	800V 15A	100	1,42 \$
	065 095 217015	MP1.5/4 1,5 mm 1 Giriş 3 Çıkış Ray Klemens Push-In Tip	800V 15A	100	1,65 \$
	065 095 4XX025	MP2.5/3 2,5 mm 1 Giriş 2 Çıkış Ray Klemens Push-In Tip	1000V 24A	100	1,79 \$
	065 095 2XX025	MP2.5/4 2,5 mm 1 Giriş 3 Çıkış Ray Klemens Push-In Tip	1000V 24A	100	2,20 \$
	065 095 1XX025	MPDL2.5 2,5 mm Çift Katlı 2 Giriş 2 Çıkış Ray Klemens Push-In Tip	1000V 24A	50	2,23 \$
	065 095 1XX004	MPDL4 4 mm Çift Katlı 2 Giriş 2 Çıkış Ray Klemens Push-In Tip	1000V 32A	50	4,82 \$
	065 095 4XX004	MP4/3 4 mm 1 Giriş 2 Çıkış Ray Klemens Push-In Tip	1000V 32A	50	2,28 \$
	065 095 2XX004	MP4/4 4 mm 1 Giriş 3 Çıkış Ray Klemens Push-In Tip	1000V 32A	50	2,75 \$
	065 095 4XX010	MP6/10/3 6/10 mm 1 Giriş 2 Çıkış Ray Klemens Push-In Tip	1000V 57A	50	4,95 \$

XX KARŞILIĞI OLAN RENK KODLARI



00
BEYAZ



11
SİYAH



12
TURUNCU



13
MAVİ



15
YEŞİL



16
KIRMIZI



17
GRİ



21
KAHVERENGİ

PROMEX SERİSİ PUSH-IN TİP RAY KLEMENSLER

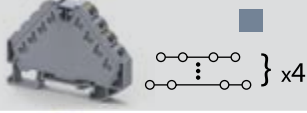
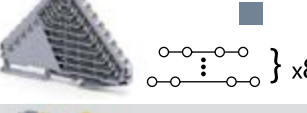
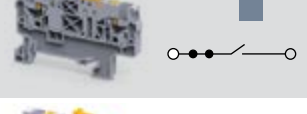
	Ürün Kodu	Ürün Adı	Gerilim / Akım V/A	Kutu Adedi	Fiyat (\$)
	065 095 317025	MPTL2.5 2,5 mm Üç Katlı 2 Giriş 2 Çıkış Ray Klemens Push-In Tip	500V 24A	50	5,50 \$
	065 095 617025	MP4L16 1,5 mm Dört Katlı 2 Giriş 2 Çıkış Ray Klemens Push-In Tip	320V 8A	10	38,33 \$
	065 095 817025	MP8L32 1,5 mm Sekiz Katlı 2 Giriş 2 Çıkış Ray Klemens Push-In Tip	320V 8A	10	51,00 \$
	065 095 017030	MPK2.5 2,5 mm Ayrırma Test Klemensi Push-In Tip	1000V 20A	100	4,76 \$
	065 095 017032	MPK4 4 mm Ayrırma Test Klemensi Push-In Tip	1000V 20A	50	5,69 \$
	065 095 117030	MPDLK2.5 2,5 mm Çift Katlı Ayrırma Klemensi Push-In Tip	500V 16A	50	15,76 \$
	065 095 017034	MPST1.5/3 1,5 mm Sensör ve Aktüatör Klemensi Push-In Tip	250V 13.5A	50	9,67 \$
	065 095 017036	MPST1.5/4 1,5 mm Sensör ve Aktüatör Klemensi Push-In Tip	250V 13.5A	50	12,00 \$

PROMEX SERİSİ TOPRAKLAMALI PUSH-IN TİP RAY KLEMENSLER

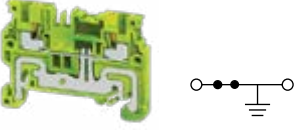
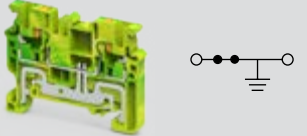
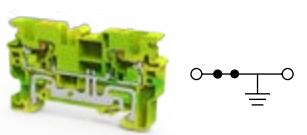
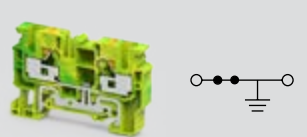



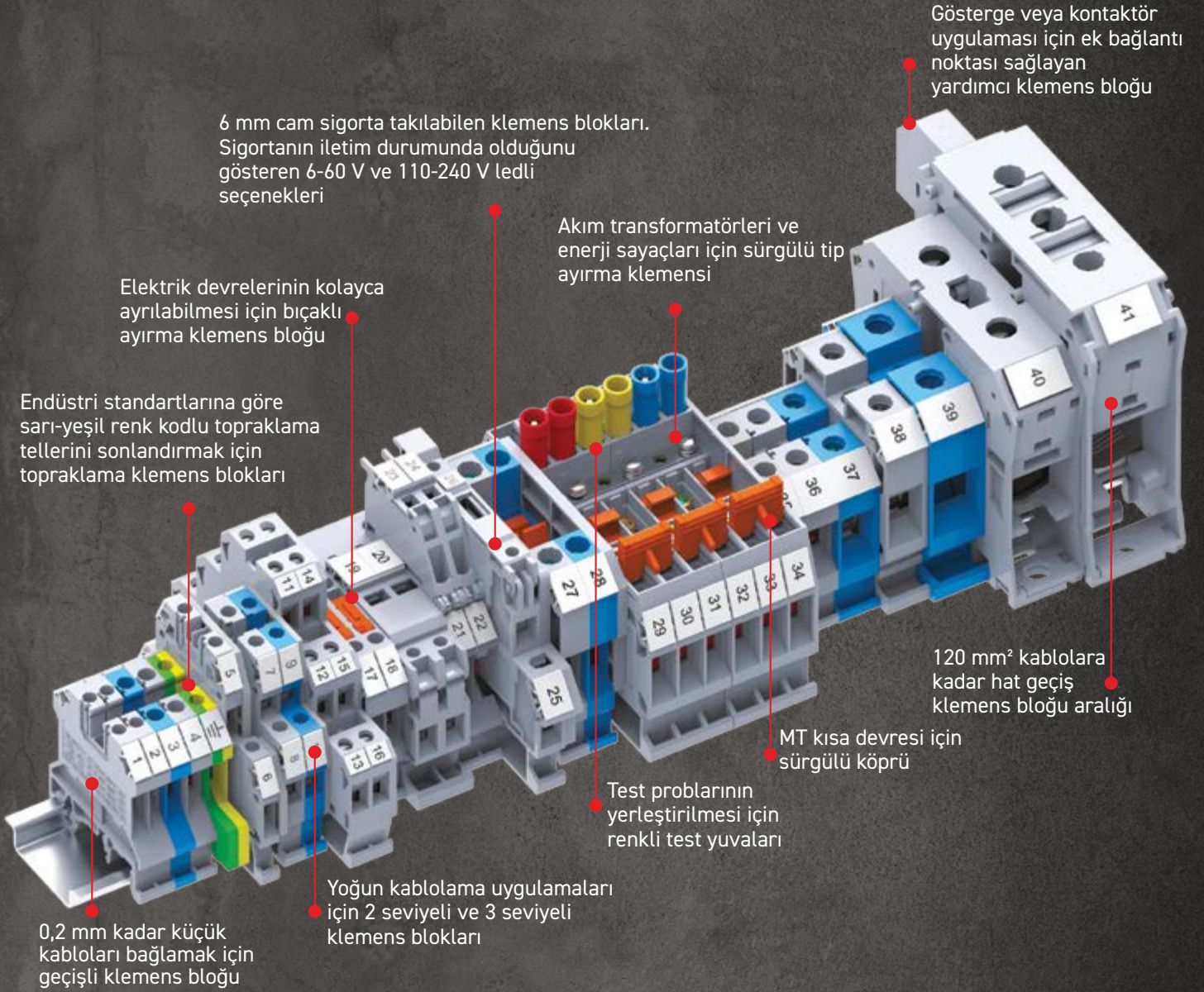





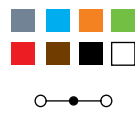

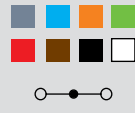

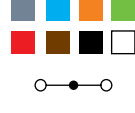

	Ürün Kodu	Ürün Adı	Kutu Adedi	Fiyat (\$)
	065 095 345015	MPG1.5 1,5 mm Ray Klemens Topraklama Push-In Tip Sarı-Yeşil	100	3,03 \$
	065 095 345025	MPG2.5 2,5 mm Ray Klemens Topraklama Push-In Tip Sarı-Yeşil	100	3,18 \$
	065 095 345004	MPG4 4 mm Ray Klemens Topraklama Push-In Tip Sarı-Yeşil	100	4,04 \$
	065 095 345010	MPG6/10 6/10 mm Ray Klemens Topraklama Push-In Tip Sarı-Yeşil	100	5,65 \$

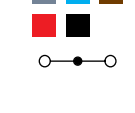
Güvenli ve Hızlı Bağlantılara Hazır Olun...

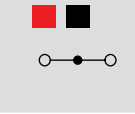

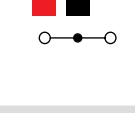
Promex
VİDALI TİP
RAY KLEMENSLER

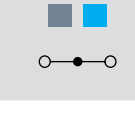
PROMEX SERİSİ VİDALI TİP RAY KLEMENSLER

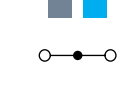
	Ürün Kodu	Ürün Adı	Gerilim / Akım V/A	Kutu Adedi	Fiyat (\$)
 	065 094 0XX025	MTS2.5UN 2,5 mm Ray Klemens Vidalı Tip	1000V 24A	100	0,66 \$
 	065 094 0XX004	MTS4UN 4 mm Ray Klemens Vidalı Tip	1000V 32A	100	0,81 \$
 	065 094 0XX006	MTS6U 6 mm Ray Klemens Vidalı Tip	1000V 41A	100	1,19 \$
 	065 094 0XX010	MTS10U 10 mm Ray Klemens Vidalı Tip	1000V 57A	100	1,49 \$
 	065 094 0XX016	MTS16U 16 mm Ray Klemens Vidalı Tip	1000V 76A	50	2,29 \$
 	065 094 0XX026	MTS25U 25 mm Ray Klemens Vidalı Tip	1000V 101A	50	3,89 \$
 	065 094 0XX035	MTS35U 35 mm Ray Klemens Vidalı Tip	1000V 125A	50	4,76 \$
 	065 094 0XX070	MTS50/70N 50/70 mm Ray Klemens Vidalı Tip	1000V 192A	20	17,24 \$
 	065 094 0XX120	MTS95/120N 95/120 mm Ray Klemens Vidalı Tip	1000V 269A	10	25,66 \$

XX KARŞILIĞI OLAN RENK KODLARI



00
BEYAZ



11
SİYAH



12
TURUNCU



13
MAVİ



15
YEŞİL



16
KIRMIZI



17
GRİ



21
KAHVERENGİ











PROMEX SERİSİ VIDALI TİP RAY KLEMENSLER

	Ürün Kodu	Ürün Adı	Gerilim / Akım V/A	Kutu Adedi	Fiyat (\$)
	065 094 017150	MPTB120/150 120/150 mm Ray Klemens Vidalı tip	1000V 310A	5	33,00 \$
	065 094 017240	MPTB185/240 185/240 mm Ray Klemens Vidalı tip	1000V 420A	2	55,00 \$
	065 094 417025	MMC1-2 2,5 mm 1 Giriş 2 Çıkış Ray Klemens Vidalı Tip	630V 32A	100	1,20 \$
	065 094 217025	MMC2-2 2,5 mm 2 Giriş 2 Çıkış Ray Klemens Vidalı Tip	630V 32A	50	1,46 \$
	065 094 117025	MDL2,5A 2,5 mm Çift Katlı 2 Giriş 2 Çıkış Ray Klemens Vidalı Tip	800V 24A	50	3,14 \$
	065 094 117004	MDL4UN 4 mm Çift Katlı 2 Giriş 2 Çıkış Ray Klemens Vidalı Tip	800V 32A	100	2,33 \$

PROMEX SERİSİ TOPRAKLAMALI VİDALI TİP RAY KLEMENSLER

	Ürün Kodu	Ürün Adı	Kutu Adedi	Fiyat (\$)
	065 094 345025	MTSG2.5 2,5 mm Ray Klemens Topraklama Vidalı Tip Sarı-Yeşil	50	2,94 \$
	065 094 345004	MTSG4 4 mm Ray Klemens Topraklama Vidalı Tip Sarı-Yeşil	50	3,30 \$
	065 094 345006	MGT6N 6 mm Ray Klemens Topraklama Vidalı Tip Sarı-Yeşil	50	3,66 \$
	065 094 345010	MGT10N 10 mm Ray Klemens Topraklama Vidalı Tip Sarı-Yeşil	50	4,59 \$
	065 094 345016	MGT16N 16 mm Ray Klemens Topraklama Vidalı Tip Sarı-Yeşil	50	6,60 \$
	065 094 345035	MGT35U 35 mm Ray Klemens Topraklama Vidalı Tip Sarı-Yeşil	20	12,10 \$
	065 094 345070	MGT50/70N 50/70 mm Ray Klemens Topraklama Vidalı Tip Sarı-Yeşil	20	33,00 \$

PROMEX SERİSİ RAY KLEMENSLER İÇİN AKSESUARLAR

	Ürün Kodu	Ürün Adı	Kutu Adedi	Fiyat (\$)
	065 095 017038	MPA Bıçaklı Sigorta Klemensi Push-in Tip 1000V / 30A	50	26,95 \$
	065 096 000062	MF4U Sigortalı Klemens 800V / 6,3A	100	3,49 \$
	065 096 000064	MF4UL6 Sigortalı Klemens Ledli 6 - 60 V AC/DC	100	4,21 \$
	065 096 000066	MF4UL11 Sigortalı Klemens Ledli 220V 110-240V AC/DC	100	6,60 \$
	065 096 000061	MSGU/TS Test Klemensi Vidalı Tip	50	10,50 \$
	065 096 000068	MA802 Durdurucu Kapak - Vidalı	50	0,80 \$
	065 096 000069	MA103 Durdurucu Kapak - Vidalısız	50	0,83 \$
	065 096 000070	MGMH6 Grup Etiketi	25	0,69 \$
	065 096 000050	MPPCX4 4 mm Bölüm Plakası	50	0,60 \$
	065 096 000142	TX2.5 2,5 mm Push-in Modülü	20	8,62 \$
	065 096 000080	MA741/10 MTS2,5 için Üst Köprü Vidalı Tip 10'lu - 24A	10	5,00 \$
	065 096 000082	MA742/10 MTS4UN / MCMC1 / MCMC2 için Üst Köprü Vidalı Tip 10'lu - 32A	10	5,00 \$
	065 096 000084	MA743/10 MTS6U için Üst Köprü Vidalı Tip 10'lu - 41A	10	5,00 \$
	065 096 000086	MA744/10 MTS10U için Üst Köprü Vidalı Tip 10'lu - 57A	10	6,67 \$
	065 096 000088	MA747/10 MDL4UN için Üst Köprü Çift Katlı Vidalı Tip 10'lu - 32A	10	5,00 \$
	065 096 000090	MA722/10 MTS4UN / MMC1 / MMC2 için İzolesiz - Üst Köprü Vidalı Tip 10'lu - 32A	10	5,00 \$
	065 096 000092	MJX1.5/10 1,5 mm için Üst Köprü Push-in Tip 10'lu	10	5,80 \$
	065 096 000020	MJX2.5/10 2,5 mm için Üst Köprü Push-in Tip 10'lu - 24A	10	3,33 \$
	065 096 000022	MJX4/10 4 mm için Üst Köprü Push-in Tip 10'lu - 32A	10	3,83 \$
	065 096 000044	MJX6/10 6/10 mm için Köprü Push-in Tip 10'lu - 41A	10	5,00 \$

RAY KLEMENS SONLAMA KAPAKLARI

Ürün Kodu	Ürün Adı	Kutu Adedi	Fiyat (\$)
065 096 000114	MEPX2.5/4 MTS2,5 ve MTS4 için Yan Kapak Vidalı Tip	50	0,50 \$
065 096 000074	MEP6/10 MTS6 ve MTS10 için Yan Kapak Vidalı Tip	50	0,63 \$
065 096 000116	MEPC1.5 MP1,5 ve MPG1,5 için Yan Kapak Push-in Tip	50	0,60 \$
065 096 000052	MEPCX2.5 MP2,5 ve MPG2,5 için Yan Kapak Push-in Tip	50	0,50 \$
065 096 000054	MEPCX4 MP4 ve MPG4 için Yan Kapak Push-in Tip	50	0,50 \$
065 096 000056	MEPCX6 MP6/10 ve MPG6/10 için Yan Kapak Push-in Tip	50	0,50 \$
065 096 000118	MEPCP1.5/3 MP1,5/3 için Çoklu Yan Kapak Push-in Tip	50	0,60 \$
065 096 000120	MEPCX1.5/4 MP1,5/4 için Çoklu Yan Kapak Push-in Tip	50	0,73 \$
065 096 000122	MEPCX2.5/3 MP2,5/3 ve MPK2,5 için Çoklu Yan Kapak Push-in Tip	50	0,67 \$
065 096 000072	MEP2.5/4 MP2,5/4 için Çoklu Yan Kapak Push-in Tip	50	0,63 \$
065 096 000060	MEPCDL2.5 MPDL2,5 için Çift Katlı Yan Kapak Push-in Tip	10	0,53 \$
065 096 000076	MEPCDL4 MDL4UN için Yan Kapak Vidalı Tip	10	0,83 \$
065 096 000202	MEPCMC1-2 MMC1-2 için Yan Kapak Vidalı Tip	50	0,53 \$
065 096 000204	MEPCMC2-2 MMC2-2 için Yan Kapak Vidalı Tip	50	0,61 \$
065 096 000206	MEPODL2.5 MDL2,5A için Yan Kapak Vidalı Tip	50	0,58 \$
065 096 000208	MEPCDS6U MS6U/TS için Yan Kapak Vidalı Tip	50	0,93 \$
065 096 000210	MEPCX4/3 MP4/3 için Yan Kapak Push-in Tip	50	0,58 \$
065 096 000212	MEPCX4/4 MP4/4 için Yan Kapak Push-in Tip	50	0,55 \$
065 096 000214	MEPCX6/3 MP6/10/3 için Yan Kapak Push-in Tip	50	0,58 \$
065 096 000216	MEPCPTL2.5 MPTL2,5 için Yan Kapak Push-in Tip	50	0,75 \$
065 096 000218	MEPCPPT2.5/3 MPST1,5/3 için Yan Kapak Push-in Tip	50	1,25 \$
065 096 000220	MEPCPPT2.5/4 MPST1,5/4 için Yan Kapak Push-in Tip	50	1,51 \$
065 096 000221	MEPCPDLK2.5 MPDLK2,5 için Yan Kapak Push-in Tip	50	0,93 \$

RAY KLEMENS İÇİN DEKAFİKLER

Ürün Kodu	Ürün Adı	Kutu Adedi	Fiyat (\$)
065 096 000100	MC3.5 1,5 mm için Dekafix - Yazısız	1200	0,05 \$
065 096 000101	MC3.5 1,5 mm için Dekafix (1-50)	1200	0,05 \$
065 096 000222	MC3.5 1,5 mm için Dekafix (51-99)	1200	0,05 \$
065 096 000223	MC3.5 1,5 mm için Dekafix (+-)	1200	0,05 \$
065 096 000224	MC3.5 1,5 mm için Dekafix (L,N,PE)	1200	0,05 \$
065 096 000102	MC5 2,5 mm için Dekafix- Yazısız	840	0,05 \$
065 096 000103	MC5 2,5 mm için Dekafix (1-50)	840	0,05 \$
065 096 000225	MC5 2,5 mm için Dekafix (51-99)	840	0,05 \$
065 096 000226	MC5 2,5 mm için Dekafix (+-)	840	0,05 \$
065 096 000227	MC5 2,5 mm için Dekafix (L,N,PE)	840	0,05 \$
065 096 000104	MC6 4 mm için Dekafix - Yazısız	720	0,05 \$
065 096 000105	MC6 4 mm için Dekafix (1-50)	720	0,05 \$
065 096 000228	MC6 4 mm için Dekafix (51-99)	720	0,05 \$
065 096 000229	MC6 4 mm için Dekafix (+-)	720	0,05 \$
065 096 000230	MC6 4 mm için Dekafix (L,N,PE)	720	0,05 \$
065 096 000106	MC8 6 mm için Dekafix - Yazısız	480	0,05 \$
065 096 000107	MC8 6 mm için Dekafix (1-50)	480	0,05 \$
065 096 000231	MC8 6 mm için Dekafix (51-99)	480	0,05 \$
065 096 000232	MC8 6 mm için Dekafix (+-)	480	0,05 \$
065 096 000233	MC8 6 mm için Dekafix (L,N,PE)	480	0,05 \$
065 096 000108	MC10 10 mm için Dekafix - Yazısız	420	0,05 \$
065 096 000109	MC10 10 mm için Dekafix (1-50)	420	0,05 \$
065 096 000234	MC10 10 mm için Dekafix (51-99)	420	0,05 \$
065 096 000235	MC10 10 mm için Dekafix (+-)	420	0,05 \$
065 096 000236	MC10 10 mm için Dekafix (L,N,PE)	420	0,05 \$
065 096 000110	MC12 16 mm için Dekafix - Yazısız	360	0,05 \$
065 096 000111	MC12 16 mm için Dekafix (1-50)	360	0,05 \$
065 096 000237	MC12 16 mm için Dekafix (51-99)	360	0,05 \$
065 096 000238	MC12 16 mm için Dekafix (+-)	360	0,05 \$
065 096 000239	MC12 16 mm için Dekafix (L,N,PE)	360	0,05 \$
065 096 000112	MC16 35-120 mm için Dekafix - Yazısız	240	0,05 \$
065 096 000113	MC16 35-120 mm için Dekafix (1-50)	240	0,05 \$
065 096 000240	MC16 35-120 mm için Dekafix (51-99)	240	0,05 \$
065 096 000241	MC16 35-120 mm için Dekafix (+-)	240	0,05 \$
065 096 000242	MC16 35-120 mm için Dekafix (L,N,PE)	240	0,05 \$



Promex

ETİKET MAKİNESİ



60 Metrelik Şerit Etiket için Maksimum Baskı;

- 1,5 mm² için 17.000
- 2,5 mm² için 12.000
- 4 mm² için 10.000
- 6 mm² için 7.500
- 10 mm² için 6.000



ETİKET MAKİNESİ ve AKSESUARLARI

Ürün Kodu	Ürün Adı	Kutu Adedi	Fiyat (\$)
065 096 000124	Promex Etiket Makinesi	1	925,93 \$
065 096 000129	Promex Şerit Etiketi 20 m (3x20 m)	1	37,04 €
065 096 000130	Promex Etiketi - 27x12 mm - Gümüş	1	0,35 €
065 096 000132	Promex Etiketi - 15x6 mm - Gümüş	1	0,28 €
065 096 000134	Promex Ribon - Siyah	1	74,07 €
065 096 000136	Promex Ribon - Kırmızı	1	101,85 €
065 096 000138	Promex Ribon - Mavi	1	101,85 €

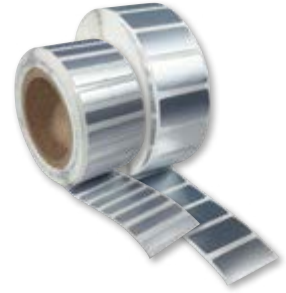

ISIYLA DARALAN MAKARONLAR

Ürün Kodu	Ürün Adı	Kutu Adedi	Fiyat (\$)
065 096 000310	3 mm Makaron - Sarı	200 m.	FİYAT SORUNUZ
065 096 000312	4 mm Makaron - Sarı	100 m.	
065 096 000314	6 mm Makaron - Sarı	100 m.	



ŞEFFAF TÜP ve ETİKETLERİ

Ürün Kodu	Ürün Adı	Kutu Adedi	Fiyat (\$)
065 096 000300	20x4 mm Şeffaf Tüp Etiketi - Sarı	1000	FİYAT SORUNUZ
065 096 000302	20 mm Şeffaf Tüp (0,5 - 1,5 mm ² Kablolar için)	500	
065 096 000304	20 mm Şeffaf Tüp (1,5 - 2,5 mm ² Kablolar için)	500	
065 096 000306	20 mm Şeffaf Tüp (2,5 - 4,0 mm ² Kablolar için)	500	
065 096 000308	20 mm Şeffaf Tüp (4,0 - 6,0 mm ² Kablolar için)	500	



ALEV YAYMAYAN SIRA KLEMENSLER

Güvenli Bağlantılar İçin İdeal Seçim!



850°C
ALEV YAYMAZLIK

750° ALEV YAYMAYAN SIRA KLEMENSLER (MAVİ)



Ürün Kodu	Ürün Adı	Kutu Adet	Koli Adet	Fiyat (₺)
015 094 150001	NO.1 750° ALEV YAYMAYAN SIRA KLEMENS (2.5-4 mm ²)	50	600	55,91
015 094 150002	NO.2 750° ALEV YAYMAYAN SIRA KLEMENS (4-6 mm ²)	50	400	72,93
015 094 150003	NO.3 750° ALEV YAYMAYAN SIRA KLEMENS (6-10 mm ²)	50	300	97,74
015 094 150004	NO.4 750° ALEV YAYMAYAN SIRA KLEMENS (10-16 mm ²)	50	400	100,24
015 094 150005	NO.5 750° ALEV YAYMAYAN SIRA KLEMENS (16-25 mm ²)	50	300	118,15

850° ALEV YAYMAYAN SIRA KLEMENSLER (BEYAZ)



Ürün Kodu	Ürün Adı	Kutu Adet	Koli Adet	Fiyat (₺)
015 094 170001	NO.1 850° ALEV YAYMAYAN SIRA KLEMENS (2.5-4 mm ²)	50	600	59,52
015 094 170002	NO.2 850° ALEV YAYMAYAN SIRA KLEMENS (4-6 mm ²)	50	400	77,56
015 094 170003	NO.3 850° ALEV YAYMAYAN SIRA KLEMENS (6-10 mm ²)	50	300	105,93
015 094 170004	NO.4 850° ALEV YAYMAYAN SIRA KLEMENS (10-16 mm ²)	50	400	106,43
015 094 170005	NO.5 850° ALEV YAYMAYAN SIRA KLEMENS (16-25 mm ²)	50	300	130,37

GEÇMELİ ve TIRNAK TİP BUAT KLEMENSLER



Ürün Kodu	Ürün Adı	Kutu Adet	Koli Adet	Fiyat
SWISS GEÇMELİ BUAT KLEMENS				₺
999 094 225000	2'Lİ GEÇMELİ BUAT KLEMENS (0,5-2,5 mm ²)	100	6000	0,14 \$
999 094 325000	3'LÜ GEÇMELİ BUAT KLEMENS (0,5-2,5 mm ²)	100	6000	0,14 \$
999 094 425000	4'LÜ GEÇMELİ BUAT KLEMENS (0,5-2,5 mm ²)	100	6000	0,17 \$
999 094 525000	5'Lİ GEÇMELİ BUAT KLEMENS (0,5-2,5 mm ²)	100	6000	0,19 \$
999 094 625000	6'Lİ GEÇMELİ BUAT KLEMENS (0,5-2,5 mm ²)	50	2500	0,26 \$
999 094 825000	8'Lİ GEÇMELİ BUAT KLEMENS (0,5-2,5 mm ²)	50	2500	0,29 \$
SWISS TIRNAKLI BUAT KLEMENS				₺
999 094 241000	2'Lİ TIRNAKLI BUAT KLEMENS (0,2-4 mm ²)	100	5000	0,26 \$
999 094 341000	3'LÜ TIRNAKLI BUAT KLEMENS (0,2-4 mm ²)	100	5000	0,35 \$
999 094 441000	4-LÜ TIRNAKLI BUAT KLEMENS (0,2-4 mm ²)	50	2500	0,42 \$
999 094 541000	5'Lİ TIRNAKLI BUAT KLEMENS (0,2-4 mm ²)	50	2500	0,50 \$
ŞEFFAF ISIYA DAYANIKLI BUAT KLEMENSLER				₺
888 094 000105	NO.2 ŞEFFAF BUAT KLEMENS (1 ADET FİYAT)	560		9,41
888 094 000205	NO.3 ŞEFFAF BUAT KLEMENS (1 ADET FİYAT)	360		13,32
888 094 000405	NO.4 ŞEFFAF BUAT KLEMENS (1 ADET FİYAT)	200		21,91
888 094 000605	NO.5 ŞEFFAF BUAT KLEMENS (1 ADET FİYAT)	120		29,64
PORSELEN KLEMENSLER				₺
015 094 180002	NO. 1-2'Lİ PORSELEN KLEMENS (2,5-4 mm ²)	396	1584	24,26
015 094 180003	NO. 1-3'LÜ PORSELEN KLEMENS (2,5-4 mm ²)	264	1056	29,46
015 094 180004	NO. 2-2'Lİ PORSELEN KLEMENS (4-6 mm ²)	250	1000	29,46
015 094 180005	NO. 2-3'LÜ PORSELEN KLEMENS (4-6 mm ²)	150	600	42,16
015 094 180006	NO. 3-2'Lİ PORSELEN KLEMENS (6-10 mm ²)	128	512	42,16
015 094 180007	NO. 3-3'LÜ PORSELEN KLEMENS (6-10 mm ²)	84	336	65,00
GEÇMELİ SOKET KLEMENSLER				₺
999 999 991212	12'Lİ GEÇMELİ SOKET KLEMENS (850°C ALEV YAYMAYAN)	25	500	284,72
U KLEMENSLER				₺
014 094 030006	6'LİK U KLEMENS	300		63,66
014 094 030010	10'LUK U KLEMENS	250		86,57
014 094 030016	16'LİK U KLEMENS	100		132,41
014 094 030025	25'LİK U KLEMENS	100		157,87
014 094 030035	35'LİK U KLEMENS	75		183,33
014 094 030050	50'LİK U KLEMENS	50		290,28
014 094 030070	70'LİK U KLEMENS	40		376,85
014 094 030095	95'LİK U KLEMENS	25		468,52
014 094 030120	120'LİK U KLEMENS	20		611,11
014 094 030150	150'LİK U KLEMENS	15		789,35

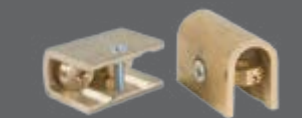

PANO TOPRAKLAMA KLEMENLERİ (6x8 mm) 63A

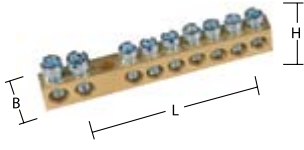

Ürün Kodu	Ürün Adı	L	B	H	Kutu Adet	Fiyat (₺)
014 102 006304	4 DELİK PANO TOPRAKLAMA KLEMENS	6	8	33	100	57,20
014 102 006305	5 DELİK PANO TOPRAKLAMA KLEMENS	6	8	38	100	64,35
014 102 006306	6 DELİK PANO TOPRAKLAMA KLEMENS	6	8	45	100	76,80
014 102 006307	7 DELİK PANO TOPRAKLAMA KLEMENS	6	8	50	100	84,08
014 102 006309	9 DELİK PANO TOPRAKLAMA KLEMENS	6	8	62	100	96,53
014 102 006310	10 DELİK PANO TOPRAKLAMA KLEMENS	6	8	68	100	117,84
014 102 006312	12 DELİK PANO TOPRAKLAMA KLEMENS	6	8	80	100	143,00

PANO TOPRAKLAMA KLEMENLERİ AYAKLI (6,5X9 mm) 80A

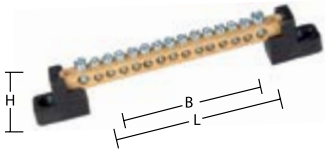

Ürün Kodu	Ürün Adı	L	B	H	Kutu Adet	Fiyat (₺)
014 102 008006	6 DELİK AYAKLI DAĞITIM ÜNİTESİ	85	70	22	200	135,85
014 102 008010	10 DELİK AYAKLI DAĞITIM ÜNİTESİ	108	95	22	150	178,75
014 102 008012	12 DELİK AYAKLI DAĞITIM ÜNİTESİ	120	106	22	150	193,31
014 102 008015	15 DELİK AYAKLI DAĞITIM ÜNİTESİ	138	124	22	125	230,39
014 102 008020	20 DELİK AYAKLI DAĞITIM ÜNİTESİ	165	152	22	100	304,54

1 KUTUP DAĞITIM ÜNİTESİ 125A

CE

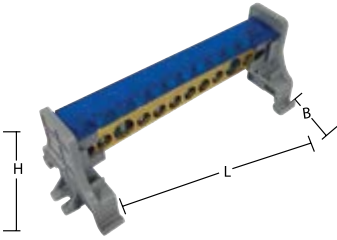

Ürün Kodu	Ürün Adı	Cinsi	L	B	H	Koli Adet	Fiyat (₺)
014 102 112507	125A 1 KUTUP DAĞITIM ÜNİTESİ	2+5	76	44	42	70	321,75
014 102 112510	125A 1 KUTUP DAĞITIM ÜNİTESİ	2+8	100	44	42	60	376,04
014 102 112512	125A 1 KUTUP DAĞITIM ÜNİTESİ	2+10	115	44	42	55	429,00
014 102 112515	125A 1 KUTUP DAĞITIM ÜNİTESİ	2+13	135	44	42	45	548,17
014 102 112520	125A 1 KUTUP DAĞITIM ÜNİTESİ	2+18	170	44	42	35	677,93
014 102 112522	125A 1 KUTUP DAĞITIM ÜNİTESİ	2+20	185	44	42	35	752,07

2 KUTUP DAĞITIM ÜNİTESİ 125A

CE

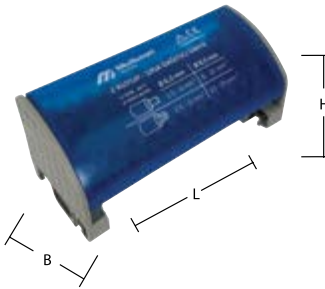

Ürün Kodu	Ürün Adı	Cinsi	L	B	H	Koli Adet	Fiyat (₺)
014 102 212507	125A 2 KUTUP DAĞITIM ÜNİTESİ	2+5	81	90	50	22	662,04
014 102 212510	125A 2 KUTUP DAĞITIM ÜNİTESİ	2+8	103	90	50	15	715,00
014 102 212512	125A 2 KUTUP DAĞITIM ÜNİTESİ	2+10	118	90	50	14	794,44
014 102 212515	125A 2 KUTUP DAĞITIM ÜNİTESİ	2+13	142	90	50	12	1.019,54
014 102 212520	125A 2 KUTUP DAĞITIM ÜNİTESİ	2+18	178	90	50	6	1.276,41

4 KUTUP DAĞITIM ÜNİTESİ 125A

CE

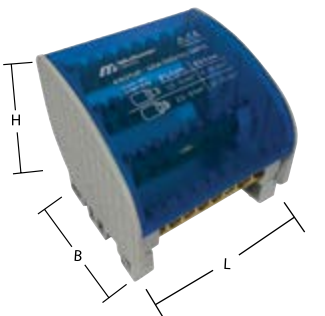

Ürün Kodu	Ürün Adı	Cinsi	L	B	H	Koli Adet	Fiyat (₺)
014 102 412507	125A 4 KUTUP DAĞITIM ÜNİTESİ	2+5	60	80	75	10	1.233,38
014 102 412510	125A 4 KUTUP DAĞITIM ÜNİTESİ	2+8	83	80	75	8	1.340,63
014 102 412512	125A 4 KUTUP DAĞITIM ÜNİTESİ	2+10	97	80	75	6	1.483,63
014 102 412515	125A 4 KUTUP DAĞITIM ÜNİTESİ	2+13	120	80	75	5	1.840,46
014 102 412520	125A 4 KUTUP DAĞITIM ÜNİTESİ	2+18	155	80	75	4	2.395,25
014 102 412522	125A 4 KUTUP DAĞITIM ÜNİTESİ	2+20	170	80	75	4	2.556,13
014 102 412525	125A 4 KUTUP DAĞITIM ÜNİTESİ	2+23	191	80	75	4	2.948,71



KABLO BAĞLARI

Kendinden Kilitlemeli Sistem
Kolay ve Hızlı Montaj
1.Sınıf Malzeme



Siyah Ürün Kodu	Genişlik X Uzunluk (mm)	Taşıma Kapasitesi		Ürün Adı	Kutu Adet	Koli Adet	Fiyat (₺)	
		kg	lbs					
ULTRAVİYOLE KABLO BAĞLARI (SİYAH) 								
062 129 225100	2,5x100	12	26	KABLO BAĞI	1000 ad.	60.000	0,38	
062 129 225140	2,5x140	12	26	KABLO BAĞI	100 ad.	35.000	0,58	
062 129 225200	2,5x200	12	26	KABLO BAĞI	100 ad.	25.000	0,83	
062 129 236150	3,6x150	18	26	KABLO BAĞI	100 ad.	25.000	0,98	
062 129 236205	3,6x205	18	40	KABLO BAĞI	100 ad.	20.000	1,33	
062 129 236250	3,6x250	18	40	KABLO BAĞI	100 ad.	18.000	1,60	
062 129 236300	3,6x300	18	40	KABLO BAĞI	100 ad.	15.000	2,03	
062 129 236370	3,6x370	18	40	KABLO BAĞI	100 ad.	12.000	2,55	
062 129 248200	4,8x200	25	40	KABLO BAĞI	100 ad.	12.000	1,96	
062 129 248250	4,8x250	25	55	KABLO BAĞI	100 ad.	12.000	2,29	
062 129 248300	4,8x300	25	55	KABLO BAĞI	100 ad.	11.000	2,88	
062 129 248350	4,8x350	25	55	KABLO BAĞI	100 ad.	9.000	3,33	
062 129 248400	4,8x400	25	55	KABLO BAĞI	100 ad.	8.000	3,79	
062 129 248450	4,8x450	25	55	KABLO BAĞI	100 ad.	6.000	4,51	
062 129 208250	8x250	55	55	KABLO BAĞI	100 ad.	6.000	4,58	
062 129 208300	8x300	55	121	KABLO BAĞI	100 ad.	5.000	6,08	
062 129 208380	8x380	55	121	KABLO BAĞI	100 ad.	5.000	6,54	
062 129 208450	8x450	55	121	KABLO BAĞI	100 ad.	3.500	7,32	
062 129 208550	8x550	55	121	KABLO BAĞI	100 ad.	2.500	9,81	
062 129 208750	8x750	55	121	KABLO BAĞI	100 ad.	2.000	15,69	
062 129 209762	9x762	80	177	KABLO BAĞI	100 ad.	1.500	20,92	
062 129 209940	9x940	80	177	KABLO BAĞI	100 ad.	1.500	24,19	
Beyaz Ürün Kodu	Siyah Ürün Kodu	Genişlik X Uzunluk (mm)	Taşıma Kapasitesi		Ürün Adı	Kutu Adet	Koli Adet	Fiyat (₺)
			kg	lbs				



MUTLUSAN KABLO BAĞLARI (SİYAH-BEYAZ)

062 129 025100	062 129 125100	2,5x100	12	26	KABLO BAĞI	1000 ad.	60.000	0,35
062 129 025140	062 129 125140	2,5x140	12	26	KABLO BAĞI	100 ad.	35.000	0,52
062 129 025200	062 129 125200	2,5x200	12	26	KABLO BAĞI	100 ad.	25.000	0,76
062 129 036150	062 129 136150	3,6x150	18	26	KABLO BAĞI	100 ad.	25.000	0,89
062 129 036205	062 129 136205	3,6x205	18	40	KABLO BAĞI	100 ad.	20.000	1,21
062 129 036250	062 129 136250	3,6x250	18	40	KABLO BAĞI	100 ad.	18.000	1,45
062 129 036300	062 129 136300	3,6x300	18	40	KABLO BAĞI	100 ad.	15.000	1,84
062 129 036370	062 129 136370	3,6x370	18	40	KABLO BAĞI	100 ad.	12.000	2,32
062 129 048200	062 129 148200	4,8x200	25	40	KABLO BAĞI	100 ad.	12.000	1,78
062 129 048250	062 129 148250	4,8x250	25	55	KABLO BAĞI	100 ad.	12.000	2,08
062 129 048300	062 129 148300	4,8x300	25	55	KABLO BAĞI	100 ad.	11.000	2,62
062 129 048350	062 129 148350	4,8x350	25	55	KABLO BAĞI	100 ad.	9.000	3,03
062 129 048400	062 129 148400	4,8x400	25	55	KABLO BAĞI	100 ad.	8.000	3,45
062 129 048450	062 129 148450	4,8x450	25	55	KABLO BAĞI	100 ad.	6.000	4,10
062 129 008250	062 129 108250	8x250	55	55	KABLO BAĞI	100 ad.	6.000	4,16
062 129 008300	062 129 108300	8x300	55	121	KABLO BAĞI	100 ad.	5.000	5,53
062 129 008380	062 129 108380	8x380	55	121	KABLO BAĞI	100 ad.	5.000	5,94
062 129 008450	062 129 108450	8x450	55	121	KABLO BAĞI	100 ad.	3.500	6,66
062 129 008550	062 129 108550	8x550	55	121	KABLO BAĞI	100 ad.	2.500	8,92
062 129 008750	062 129 108750	8x750	55	121	KABLO BAĞI	100 ad.	2.000	14,27
062 129 009762	062 129 109762	9x762	80	177	KABLO BAĞI	100 ad.	1.500	18,99
062 129 009940	062 129 109940	9x940	80	177	KABLO BAĞI	100 ad.	1.500	21,99

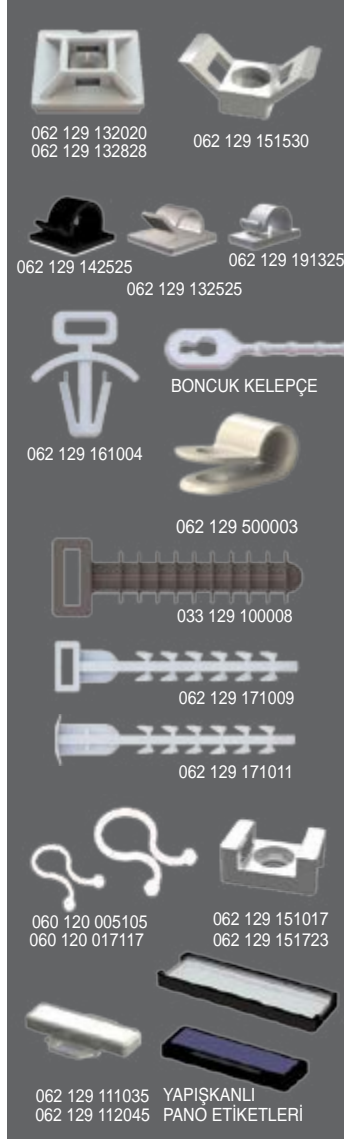

Ürün Kodu	Ürün Adı	Kutu Adet	Koli Adet	Fiyat (₺)
KROŞE VE KLİPSLER				
062 129 132020	20x20 mm YAPIŞKANLI KROŞE	100 ad.	20.000	2,25
062 129 132828	28x28 mm YAPIŞKANLI KROŞE	100 ad.	9.000	3,84
062 129 131316	13x16 mm YAPIŞKANLI KLİPS	100 ad.	7.000	2,45
062 129 191325	13x25 mm YAPIŞKANLI KLİPS	100 ad.	5.000	3,31
062 129 132525	25x25 mm YAPIŞKANLI KLİPS (BEYAZ)	100 ad.	3.000	5,21
062 129 142525	25x25 mm YAPIŞKANLI KLİPS (SİYAH)	100 ad.	2.000	5,56
062 129 151017	10x17 mm VİDALI KROŞE	250 ad.	12.500	1,80
062 129 151530	15x30 mm VİDALI KROŞE	100 ad.	5.000	2,78
062 129 151723	17x23 mm VİDALI KROŞE	250 ad.	5.000	2,26
062 129 161004	DÜBELLİ KROŞE 6 DELİK İÇİN	500 ad.	15.000	1,30
062 129 171009	DUVAR KROŞESİ 6 DELİK İÇİN	250 ad.	7.500	2,18
033 129 100008	DUVAR KROŞESİ 8 DELİK İÇİN	250 ad.	9.000	2,50
062 129 171011	KANAL KROŞESİ 6 DELİK İÇİN	250 ad.	7.500	2,18
062 129 500003	KABLO KLİPSİ 6,4 (1/4")	100 ad.	10.000	1,45
062 129 500004	KABLO KLİPSİ 7,9 (5/16")	100 ad.	5.000	1,63
062 129 500005	KABLO KLİPSİ 10,9 (3/8")	100 ad.	5.000	1,81
KELEPÇELER				
062 129 010101	2x105 mm BONCUK KELEPÇE	1000 ad.	25.000	0,77
062 129 010102	3,5x165 mm BONCUK KELEPÇE	500 ad.	8.000	1,73
062 129 500000	3,5x235 mm BONCUK KELEPÇE	100 ad.	5.000	2,76
060 120 005105	4,5 mm BURMA KELEPÇE	500 ad.	50.000	0,87
060 120 007107	7,0 mm BURMA KELEPÇE	500 ad.	45.000	1,06
060 120 010110	10,5 mm BURMA KELEPÇE	500 ad.	35.000	1,30
060 120 014114	14 mm BURMA KELEPÇE	500 ad.	30.000	1,36
060 120 017117	17 mm BURMA KELEPÇE	500 ad.	15.000	1,50
ETİKETLER				
062 129 111035	10X35 mm KABLO BAĞI ETİKETİ	100 ad.	4.000	3,70
062 129 112045	20X45 mm KABLO BAĞI ETİKETİ	100 ad.	1.500	7,41
062 129 121730	17X30 mm YAPIŞKANLI PANO ETİKETİ	100 ad.	4.000	4,79
062 129 121750	17X50 mm YAPIŞKANLI PANO ETİKETİ	50 ad.	2.000	6,44
062 129 122075	17X75 mm YAPIŞKANLI PANO ETİKETİ	25 ad.	1.500	8,66

KABLO TOPLAMA SİRİRALİ (GRİ - SİYAH)

XX yerine 00 Gri / XX yerine 11 Siyah

Ürün Kodu	Ürün Adı	Amb. Birimi	Koli Adedi	Ad. /Mt. Fiyat (\$)
888 020 9XX003	R1034 16 mm KABLO TOPLAMA SİRİRALİ (1,5m VAK)	1 ad.	60	6,88 \$
888 020 9XX006	R1035 22 mm KABLO TOPLAMA SİRİRALİ (1,5m VAK)	1 ad.	40	9,32 \$
888 020 9XX009	R1036 28 mm KABLO TOPLAMA SİRİRALİ (1,5m VAK)	1 ad.	35	12,04 \$
888 020 9XX001	R1033 10 mm KABLO TOPLAMA SİRİRALİ (50 m RULO)	50 mt.	200	2,87 \$
888 020 9XX004	R1034 16 mm KABLO TOPLAMA SİRİRALİ (25 m RULO)	25 mt.	100	3,51 \$
888 020 9XX007	R1035 22 mm KABLO TOPLAMA SİRİRALİ (20 m RULO)	20 mt.	80	4,95 \$
888 020 9XX010	R1036 28 mm KABLO TOPLAMA SİRİRALİ (15 m RULO)	15 mt.	60	6,29 \$
888 020 9XX011	R1037 34 mm KABLO TOPLAMA SİRİRALİ (25 m RULO)	25 mt.	50	7,33 \$

HELEZON PANO SİRİRALİ

XX yerine 00 Şeffaf / XX yerine 11 Siyah

Ürün Kodu	Ürün Adı	İç Çap	Dış Çap	Amb. Birimi	Koli Adedi	Fiyat (₺)
001 020 500001 05 XX	NO.1 PANO SİRİRALİ (50cm)	5	6	100 ad.	4.000	6,27
001 020 500002 05 XX	NO.2 PANO SİRİRALİ (50cm)	7	8	100 ad.	3.000	8,33
001 020 500003 05 XX	NO.3 PANO SİRİRALİ (50cm)	10	11	100 ad.	2.000	9,77
001 020 500004 05 XX	NO.4 PANO SİRİRALİ (50cm)	13	14	50 ad.	800	17,84
001 020 500005 05 XX	NO.5 PANO SİRİRALİ (50cm)	16	17	25 ad.	800	18,28

HELEZON PANO SİRİRALİ (RULO)

XX yerine 00 Şeffaf / XX yerine 11 Siyah

Ürün Kodu	Ürün Adı	İç Çap	Dış Çap	Amb. Birimi	Koli Adedi	Fiyat (₺)
001 020 600001 00 XX	NO.1 PANO SİRİRALİ (100cm)	5	6	100 ad.	4.000	12,68
001 020 600002 00 XX	NO.2 PANO SİRİRALİ (100cm)	7	8	100 ad.	3.000	15,55
001 020 600003 00 XX	NO.3 PANO SİRİRALİ (100cm)	10	11	100 ad.	2.000	18,47
001 020 600004 00 XX	NO.4 PANO SİRİRALİ (100cm)	13	14	50 ad.	800	35,16
001 020 600005 00 XX	NO.5 PANO SİRİRALİ (100cm)	16	17	25 ad.	800	36,00

R-MEKS SERİSİ

X yerine Gri için 7, Siyah için 1 rakamını yazınız. IP68



750°C
Alev Yaymazlık

Ürün Kodu	Ürün Adı	Kablo Sıkma Çapı	Kutu Adet	Koli Adet	Fiyat (₺)	
R-MEKS PG PLASTİK KABLO RAKORU						
010 097 1X0007	R-MEKS PG-7	PLASTİK KABLO RAKORU	3-6,5 mm	450	4.500	10,90
010 097 1X0009	R-MEKS PG-9	PLASTİK KABLO RAKORU	4-6 mm	300	3.000	12,76
010 097 1X0011	R-MEKS PG-11	PLASTİK KABLO RAKORU	5-10 mm	200	2.000	15,81
010 097 1X0135	R-MEKS PG-13,5	PLASTİK KABLO RAKORU	6-12 mm	175	1750	17,23
010 097 1X0016	R-MEKS PG-16	PLASTİK KABLO RAKORU	10-14 mm	125	1250	21,37
010 097 1X0021	R-MEKS PG-21	PLASTİK KABLO RAKORU	13-18 mm	75	750	33,80
010 097 1X0029	R-MEKS PG-29	PLASTİK KABLO RAKORU	18-25 mm	40	400	61,61
010 097 1X0036	R-MEKS PG-36	PLASTİK KABLO RAKORU	22-32 mm	20	200	105,11
010 097 1X0042	R-MEKS PG-42	PLASTİK KABLO RAKORU	32-38 mm	15	150	129,32
010 097 1X0048	R-MEKS PG-48	PLASTİK KABLO RAKORU	37-44 mm	12	120	145,67



X yerine Gri için 7, Siyah için 1 rakamını yazınız. IP68

Ürün Kodu	Ürün Adı	Kablo Sıkma Çapı	Kutu Adet	Koli Adet	Fiyat (₺)
R-MEKS METRİK PLASTİK KABLO RAKORU					
010 097 1X0712	R-MEKS M12X1,5 METRİK PLASTİK KABLO RAKORU (PG 7)	3-6,5 mm	450	4500	11,22
010 097 1X1112	R-MEKS M16X1,5 METRİK PLASTİK KABLO RAKORU (PG 11)	5-10 mm	200	2000	15,99
010 097 1X1320	R-MEKS M20X1,5 METRİK PLASTİK KABLO RAKORU (PG 13,5)	6-12 mm	175	1750	18,40
010 097 1X1620	R-MEKS M20X1,5 METRİK PLASTİK KABLO RAKORU (PG 16)	10-14 mm	125	1250	21,89
010 097 1X2125	R-MEKS M25X1,5 METRİK PLASTİK KABLO RAKORU (PG 21)	13-18 mm	75	750	34,73
010 097 1X2932	R-MEKS M32X1,5 METRİK PLASTİK KABLO RAKORU (PG 29)	18-25 mm	40	400	73,01
010 097 1X3640	R-MEKS M40X1,5 METRİK PLASTİK KABLO RAKORU (PG 36)	22-32 mm	20	200	118,71
010 097 1X4250	R-MEKS M50X1,5 METRİK PLASTİK KABLO RAKORU (PG 42)	32-38 mm	15	150	152,30
010 097 1X4863	R-MEKS M63X1,5 METRİK PLASTİK KABLO RAKORU (PG 48)	37-44 mm	12	120	184,26



R-MEKS SERİSİ



Bağlantılarınızı Güçlendirin

PG

METRİK

Her İhtiyaca Yönelik Kablo Rakorları

Promex Rakor

PLASTİK KABLO RAKORU

X yerine 0 Açık Gri / X yerine 1 Siyah / X yerine 3 Gri



Ürün Kodu	Ürün Adı	Kablo Sıkma Çapı	Delik Çapı	Kutu Adet	Koli Adet	Fiyat (€)
PROMEX SMART PLASTİK KABLO RAKORU						
057 097 411X16	16'LİK SMART KABLO RAKORU	5-10 mm	16 mm	150	1350	0,94 €
057 097 412X20	20'LİK SMART KABLO RAKORU	6-12 mm	20 mm	120	1080	0,99 €
057 097 422X25	25'LİK SMART KABLO RAKORU	11-17 mm	25 mm	50	450	1,43 €
057 097 422X32	32'LİK SMART KABLO RAKORU	15-21 mm	32 mm	40	360	2,41 €
057 097 422X40	40'LİK SMART KABLO RAKORU	19-28 mm	40 mm	20	180	4,03 €

* Smart rakorların çıkartma somunları harici olarak satılmaktadır.

X yerine 0 Açık Gri / X yerine 1 Siyah / X yerine 3 Gri

IP68



Ürün Kodu	Ürün Adı	Kablo Sıkma Çapı	Delik Çapı	Kutu Adet	Koli Adet	Fiyat (€)
PROMEX PG PLASTİK KABLO RAKORU						
057 097 211X07	PG 7 PLASTİK KABLO RAKORU	3-6,5 mm	13	450	4050	0,30 €
057 097 212X09	PG 9 PLASTİK KABLO RAKORU	4-8 mm	15,5	300	2700	0,32 €
057 097 213X11	PG 11 PLASTİK KABLO RAKORU	5-10 mm	19	200	1800	0,37 €
057 097 214X14	PG 13,5 PLASTİK KABLO RAKORU	6-12 mm	20,5	175	1575	0,43 €
057 097 215X16	PG 16 PLASTİK KABLO RAKORU	10-14 mm	22,5	125	1125	0,49 €
057 097 216X21	PG 21 PLASTİK KABLO RAKORU	13-18 mm	28,5	75	675	0,78 €
057 097 217X29	PG 29 PLASTİK KABLO RAKORU	18-25 mm	37,5	40	360	1,42 €
057 097 218X36	PG 36 PLASTİK KABLO RAKORU	22-32 mm	47,5	20	180	2,41 €
057 097 219X42	PG 42 PLASTİK KABLO RAKORU	30-38 mm	54,5	15	135	2,96 €
057 097 220X48	PG 48 PLASTİK KABLO RAKORU	34-44 mm	60,5	12	108	3,34 €

X yerine 0 Açık Gri / X yerine 1 Siyah / X yerine 3 Gri

IP68



Ürün Kodu	Ürün Adı	Kablo Sıkma Çapı	Delik Çapı (Diş Çekilmiş)	Delik Çapı (Diş Çekme)	Kutu Adedi	Koli Adedi	Fiyat (€)
PROMEX METRİK PLASTİK KABLO RAKORU							
057 097 310X12	M12x1,5 METRİK PLASTİK RAKOR	3-6,5 mm	12 mm	10,5 mm	450	4050	0,39 €
057 097 311X16	M16x1,5 METRİK PLASTİK RAKOR	5-10 mm	16 mm	14,5 mm	200	1800	0,38 €
057 097 312X20	M20x1,5 METRİK PLASTİK RAKOR	6-12 mm	20 mm	18,5 mm	175	1575	0,43 €
057 097 313X20	M20x1,5 METRİK PLASTİK RAKOR	10-14 mm	20 mm	18,5 mm	125	1125	0,54 €
057 097 314X20	M20x1,5 METRİK PLASTİK RAKOR	10-14 mm	20 mm	18,5 mm	125	1125	0,54 €
057 097 315X25	M25x1,5 METRİK PLASTİK RAKOR	13-18 mm	25 mm	23,5 mm	75	675	0,79 €
057 097 316X25	M25x1,5 METRİK PLASTİK RAKOR	13-18 mm	25 mm	23,5 mm	75	675	0,84 €
057 097 317X32	M32x1,5 METRİK PLASTİK RAKOR	18-25 mm	32 mm	30,5 mm	40	360	1,67 €
057 097 318X40	M40x1,5 METRİK PLASTİK RAKOR	22-32 mm	40 mm	38,5 mm	20	180	2,65 €
057 097 319X50	M50x1,5 METRİK PLASTİK RAKOR	30-38 mm	50 mm	48,5 mm	15	135	3,49 €
057 097 320X63	M63x1,5 METRİK PLASTİK RAKOR	34-44 mm	63 mm	61,5 mm	12	108	3,99 €

Ürün Kodu	Ürün Adı	Kablo Sıkma Çapı	Diş Boyu	Kutu Adet	Koli Adet	Fiyat (€)
PROMEX PLASTİK SİRAL RAKORLAR(GRİ)						
057 097 601007	PROMEX PG-7 SİRAL UÇLU RAKOR (GRİ)	3,00-6,50	8 mm	100	2500	1,03 €
057 097 602009	PROMEX PG-9 SİRAL UÇLU RAKOR (GRİ)	4,00-8,00	8 mm	50	1500	1,24 €
057 097 603011	PROMEX PG-11 SİRAL UÇLU RAKOR(GRİ)	5,00-10,00	8 mm	50	1500	1,38 €
057 097 604014	PROMEX PG-13,5 SİRAL UÇLU RAKOR (GRİ)	6,00-12,00	10 mm	50	1000	1,59 €
057 097 605016	PROMEX PG-16 SİRAL UÇLU RAKOR(GRİ)	10,00-14,00	10 mm	50	500	1,63 €
057 097 606021	PROMEX PG-21 SİRAL UÇLU RAKOR(GRİ)	13,00-18,00	11 mm	25	250	2,34 €



“Her Bağlantıda; KALİTE”

POLYAMİD SİRAL RAKORLARI



Ürün Kodu	Ürün Adı	Kutu Adet	Fiyat (€)
POLYAMİD SİRAL RAKORU		X yerine Gri için 7, Siyah için 1 rakamını yazınız.	
057 097 1X0007	PSR-7 SİRAL RAKORU (GRİ-SİYAH)	50	0,57 €
057 097 1X0009	PSR-9 SİRAL RAKORU (GRİ-SİYAH)	50	0,57 €
057 097 1X0011	PSR-11 SİRAL RAKORU (GRİ-SİYAH)	50	0,60 €
057 097 1X0135	PSR-13,5 SİRAL RAKORU (GRİ-SİYAH)	50	0,69 €
057 097 1X0016	PSR-16 SİRAL RAKORU (GRİ-SİYAH)	50	0,74 €
057 097 1X0021	PSR-21 SİRAL RAKORU (GRİ-SİYAH)	25	1,03 €
057 097 1X0029	PSR-29 SİRAL RAKORU (GRİ-SİYAH)	20	1,71 €
057 097 1X0036	PSR-36 SİRAL RAKORU (GRİ-SİYAH)	10	2,40 €
057 097 1X0048	PSR-48 SİRAL RAKORU (GRİ-SİYAH)	10	3,29 €



METRİK POLYAMİD SİRAL RAKORU

057 097 111012	M12X1.5 (PSR-7) POLYAMİD SİRAL RAKORU (SİYAH)	50	0,57 €
057 097 111016	M16X1.5 (PSR-9) POLYAMİD SİRAL RAKORU (SİYAH)	50	0,57 €
057 097 111018	M18X1.5 (PSR-11) POLYAMİD SİRAL RAKORU (SİYAH)	50	0,60 €
057 097 111020	M20X1.5 (PSR-13,5) POLYAMİD SİRAL RAKORU (SİYAH)	50	0,69 €
057 097 111025	M25X1.5 (PSR-16) POLYAMİD SİRAL RAKORU (SİYAH)	50	0,74 €
057 097 111125	M25X1.5 (PSR-21) POLYAMİD SİRAL RAKORU (SİYAH)	25	1,03 €
057 097 111032	M32X1.5 (PSR-29) POLYAMİD SİRAL RAKORU (SİYAH)	20	1,71 €
057 097 111040	M40X1.5 (PSR-36) POLYAMİD SİRAL RAKORU (SİYAH)	10	2,40 €
057 097 111050	M50X1.5 (PSR-48) POLYAMİD SİRAL RAKORU (SİYAH)	10	3,29 €



POLYAMİD SİRAL DİRSEĞİ

POLYAMİD SİRAL DİRSEĞİ		X yerine Gri için 7, Siyah için 0 rakamını yazınız.	
057 097 12X007	PSRD-7 SİRAL RAKORU 90° DİRSEK (GRİ-SİYAH)	50	1,20 €
057 097 12X009	PSRD-9 SİRAL RAKORU 90° DİRSEK (GRİ-SİYAH)	50	1,28 €
057 097 12X011	PSRD-11 SİRAL RAKORU 90° DİRSEK (GRİ-SİYAH)	50	1,41 €
057 097 12X135	PSRD-13,5 SİRAL RAKORU 90° DİRSEK (GRİ-SİYAH)	50	1,67 €
057 097 12X016	PSRD-16 SİRAL RAKORU 90° DİRSEK (GRİ-SİYAH)	50	1,93 €
057 097 12X021	PSRD-21 SİRAL RAKORU 90° DİRSEK (GRİ-SİYAH)	25	3,08 €



POLYAMİD SİRAL KROŞELERİ

POLYAMİD SİRAL KROŞELERİ		€ X yerine Gri için 7, Siyah için 0 rakamını yazınız.	
057 097 16X007	PG-7 POLYAMİD SİRAL KROŞESİ (GRİ-SİYAH)	50	0,70 €
057 097 16X009	PG-9 POLYAMİD SİRAL KROŞESİ (GRİ-SİYAH)	50	0,80 €
057 097 16X011	PG-11 POLYAMİD SİRAL KROŞESİ (GRİ-SİYAH)	50	0,90 €
057 097 16X135	PG-13,5 POLYAMİD SİRAL KROŞESİ (GRİ-SİYAH)	50	1,00 €
057 097 16X016	PG-16 POLYAMİD SİRAL KROŞESİ (GRİ-SİYAH)	50	1,10 €
057 097 16X021	PG-21 POLYAMİD SİRAL KROŞESİ (GRİ-SİYAH)	25	1,25 €
057 097 16X029	PG-29 POLYAMİD SİRAL KROŞESİ (GRİ-SİYAH)	25	1,52 €
057 097 16X036	PG-36 POLYAMİD SİRAL KROŞESİ (GRİ-SİYAH)	25	2,33 €
057 097 16X048	PG-48 POLYAMİD SİRAL KROŞESİ (GRİ-SİYAH)	10	3,24 €



XX yerine Gri için 17, Siyah için 11 rakamını yazınız.

Ürün Kodu	Ürün Adı	Kutu Adet	Koli Adet	Fiyat (₺)
-----------	----------	-----------	-----------	-----------

SUNFLEX POLYAMİD SİRAL BORU (UV DAYANIMLI)

Rakor Ölçüsü Ort. İç Çap Ort. Dış Çap

001 020 180007 00 XX	Ø7 POLYAMİD SİRAL BORU (UV DAYANIMLI)	PSR7	7	10,1	100 mt.	1000	27,00
001 020 180009 00 XX	Ø8,5 POLYAMİD SİRAL BORU (UV DAYANIMLI)		8,4	12,05	100 mt.	1000	29,15
001 020 180010 00 XX	Ø10 POLYAMİD SİRAL BORU (UV DAYANIMLI)	PSR9	10,2	13,1	100 mt.	1000	31,29
001 020 180012 00 XX	Ø12 POLYAMİD SİRAL BORU (UV DAYANIMLI)	PSR11	12,3	15,9	50 mt.	500	50,71
001 020 180014 00 XX	Ø14 POLYAMİD SİRAL BORU (UV DAYANIMLI)	PSR13,5	14,1	18,35	50 mt.	250	60,37
001 020 180017 00 XX	Ø17 POLYAMİD SİRAL BORU (UV DAYANIMLI)	PSR16	17	21,45	50 mt.	250	71,67
001 020 180019 00 XX	Ø19 POLYAMİD SİRAL BORU (UV DAYANIMLI)		19	24,25	50 mt.	250	83,47
001 020 180023 00 XX	Ø23 POLYAMİD SİRAL BORU (UV DAYANIMLI)	PSR21	23,25	28,5	50 mt.	250	94,70
001 020 180026 00 XX	Ø26 POLYAMİD SİRAL BORU (UV DAYANIMLI)		26,2	31,3	25 mt.	125	108,61
001 020 180029 00 XX	Ø29 POLYAMİD SİRAL BORU (UV DAYANIMLI)	PSR29	29,1	34,3	25 mt.	125	123,21
001 020 180036 00 XX	Ø36 POLYAMİD SİRAL BORU (UV DAYANIMLI)	PSR36	36,2	42,2	25 mt.	125	162,91
001 020 180048 00 XX	Ø48 POLYAMİD SİRAL BORU (UV DAYANIMLI)	PSR48	48,5	54,5	25 mt.	125	228,93

PA6 POLYAMİD SİRALER (ALEV YAYMAYAN)

001 020 170007 00 XX	MUT/PA6-7 (ALEV YAYMAYAN)	PSR7	7	10,1	100 mt.	1000	20,51
001 020 170009 00 XX	MUT/PA6-8,5 (ALEV YAYMAYAN)		8,4	12,05	100 mt.	1000	22,00
001 020 170010 00 XX	MUT/PA6-10 (ALEV YAYMAYAN)	PSR9	10,2	13,1	100 mt.	1000	23,50
001 020 170012 00 XX	MUT/PA6-12 (ALEV YAYMAYAN)	PSR11	12,3	15,9	50 mt.	500	38,08
001 020 170014 00 XX	MUT/PA6-14 (ALEV YAYMAYAN)	PSR13,5	14,1	18,35	50 mt.	250	44,17
001 020 170017 00 XX	MUT/PA6-17 (ALEV YAYMAYAN)	PSR16	17	21,45	50 mt.	250	53,14
001 020 170019 00 XX	MUT/PA6-19 (ALEV YAYMAYAN)		19	24,25	50 mt.	250	61,95
001 020 170023 00 XX	MUT/PA6-23 (ALEV YAYMAYAN)	PSR21	23,25	28,5	50 mt.	250	69,88
001 020 170026 00 XX	MUT/PA6-26 (ALEV YAYMAYAN)		26,2	31,3	25 mt.	125	80,54
001 020 170029 00 XX	MUT/PA6-29 (ALEV YAYMAYAN)	PSR29	29,1	34,3	25 mt.	125	91,52
001 020 170036 00 XX	MUT/PA6-36 (ALEV YAYMAYAN)	PSR36	36,2	42,2	25 mt.	125	120,21
001 020 170048 00 XX	MUT/PA6-48 (ALEV YAYMAYAN)	PSR48	48,5	54,5	25 mt.	125	166,68

POLİPROPİLEN SİRAL BORU

001 020 160007 00 XX	MUT/PP-7 PP SİRAL BORU	PSR7	7	10,1	100 mt.	1000	12,16
001 020 160009 00 XX	MUT/PP-8,5 PP SİRAL BORU		8,4	12,05	100 mt.	1000	12,92
001 020 160010 00 XX	MUT/PP-10 PP SİRAL BORU	PSR9	10,2	13,1	100 mt.	1000	13,68
001 020 160012 00 XX	MUT/PP-12 PP SİRAL BORU	PSR11	12,3	15,9	50 mt.	500	21,84
001 020 160014 00 XX	MUT/PP-14 PP SİRAL BORU	PSR13,5	14,1	18,35	50 mt.	250	25,61
001 020 160017 00 XX	MUT/PP-17 PP SİRAL BORU	PSR16	17	21,45	50 mt.	250	29,85
001 020 160019 00 XX	MUT/PP-19 PP SİRAL BORU		19	24,25	50 mt.	250	32,82
001 020 160023 00 XX	MUT/PP-23 PP SİRAL BORU	PSR21	23,25	28,5	50 mt.	250	36,02
001 020 160026 00 XX	MUT/PP-26 PP SİRAL BORU		26,2	31,3	25 mt.	125	44,70
001 020 160029 00 XX	MUT/PP-29 PP SİRAL BORU	PSR29	29,1	34,3	25 mt.	125	49,10
001 020 160036 00 XX	MUT/PP-36 PP SİRAL BORU	PSR36	35,8	42,2	25 mt.	125	66,10
001 020 160048 00 XX	MUT/PP-48 PP SİRAL BORU	PSR48	48,5	54,5	25 mt.	125	92,44

POLYAMİD YARIKLI SİRAL BORU (ALEV YAYMAYAN)

001 020 470007 00 XX	Ø7 POLYAMİD YARIKLI SİRAL BORU (ALEV YAYMAYAN)				100 mt.	1000	21,94
001 020 470009 00 XX	Ø8,5 POLYAMİD YARIKLI SİRAL BORU (ALEV YAYMAYAN)				100 mt.	1000	23,54
001 020 470010 00 XX	Ø10 POLYAMİD YARIKLI SİRAL BORU (ALEV YAYMAYAN)				100 mt.	1000	25,15
001 020 470012 00 XX	Ø12 POLYAMİD YARIKLI SİRAL BORU (ALEV YAYMAYAN)				100 mt.	500	40,74
001 020 470014 00 XX	Ø14 POLYAMİD YARIKLI SİRAL BORU (ALEV YAYMAYAN)				50 mt.	250	47,27
001 020 470017 00 XX	Ø17 POLYAMİD YARIKLI SİRAL BORU (ALEV YAYMAYAN)				50 mt.	250	56,86
001 020 470019 00 XX	Ø19 POLYAMİD YARIKLI SİRAL BORU (ALEV YAYMAYAN)				50 mt.	250	66,29
001 020 470023 00 XX	Ø23 POLYAMİD YARIKLI SİRAL BORU (ALEV YAYMAYAN)				50 mt.	250	74,77
001 020 470026 00 XX	Ø26 POLYAMİD YARIKLI SİRAL BORU (ALEV YAYMAYAN)				25 mt.	125	86,18
001 020 470029 00 XX	Ø29 POLYAMİD YARIKLI SİRAL BORU (ALEV YAYMAYAN)				25 mt.	125	97,93
001 020 470036 00 XX	Ø36 POLYAMİD YARIKLI SİRAL BORU (ALEV YAYMAYAN)				25 mt.	125	128,63
001 020 470048 00 XX	Ø48 POLYAMİD YARIKLI SİRAL BORU (ALEV YAYMAYAN)				25 mt.	125	178,35



KABLO YÜKSÜKLERİ



HIZ

Yüksek İletkenlik ve
Kolay Entegrasyon



PERFORMANS

Kaliteli Malzeme,
Elektriksel ve Çevresel
Dayanıklılık



BAĞLANTI

Sağlam ve Güvenilir
Bağlantılar için Doğru
Ürünler

**İZOLELİ - İZOLESİZ
FRANSIZ ve ALMAN
NORM ÇEŞİTLERİ İLE**

İZOLELİ KABLO YÜKSÜKLERİ - TEK GİRİŞ FRANSIZ - ALMAN NORMLARI

Standart : DIN 46228
Malzeme : Bakır
İzolasyon : Nylon
Voltaj : <600V
Çalışma Sıcaklığı : Max. 105°

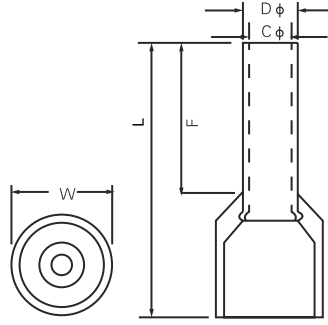

X= 0 Fransız X= F Fransız
X= 2 Alman X= A Alman

Ürün Kodu	Model Kodu	Ebatlar					Kablo Kesiti	Renk		Kutu Adet	Fiyat Adet (₺)
		F	L	W	DØ	CØ		Fransız	Alman		
014 100 X10258	ITYX-0258	8.0	12.5	2.5	1.0	0.7	0.25	Menekşe	Mavi	1.000	1,26
014 100 X10348	ITYX-0348	8.0	12.5	2.5	1.1	0.8	0.34	Pembe	Turkuaz	1.000	1,26
014 100 X10508	ITYX-0508	8.0	14.0	2.6	1.3	1.0	0.50	Beyaz	Turuncu	1.000	0,58
014 100 X17508	ITYX-7508	8.0	14.6	2.8	1.6	1.3	0.75	Mavi	Beyaz	1.000	0,58
014 100 X11008	ITYX-1008	8.0	14.6	3.0	1.8	1.5	1.0	Kırmızı	Sarı	1.000	0,58
014 100 X11508	ITYX-1508	8.0	16.4	3.5	2.1	1.8	1.5	Siyah	Kırmızı	1.000	0,64
014 100 X12508	ITYX-2508	8.0	15.2	4.0	2.6	2.3	2.5	Gri	Mavi	500	0,82
014 100 X14009	ITYX-4009	9.0	16.5	4.4	3.2	2.8	4.0	Turuncu	Gri	500	1,37
014 100 X16012	ITYX-6012	12.0	20.0	6.3	3.9	3.5	6.0	Yeşil	Siyah	250	1,89
014 100 X11012	ITYX-1012	12.0	21.5	7.6	4.9	4.5	10.0	Kahverengi	Bej	100	2,36
014 100 X11612	ITYX-1612	12.0	22.2	8.8	6.2	5.8	16.0	Bej	Yeşil	100	3,26
014 100 X12516	ITYX-2516	16.0	29.0	11.2	7.9	7.5	25.0	Siyah	Kahverengi	50	5,46
014 100 X13516	ITYX-3516	16.0	30.0	12.7	8.7	8.3	35.0	Kırmızı	Bej	25	6,83
014 100 X15020	ITYX-5020	20.0	36.0	15.3	10.9	10.3	50.0	Mavi	Yeşil	25	12,60
014 100 017020	ITYF-7020	20.0	37.0	16.0	14.3	13.5	70.0	Sarı	-	25	23,10

İZOLELİ KABLO YÜKSÜKLERİ - ÇİFT GİRİŞ FRANSIZ - ALMAN NORMLARI

Standart : DIN 46228
Malzeme : Bakır
İzolasyon : Nylon
Voltaj : <600V
Çalışma Sıcaklığı : Max. 105°

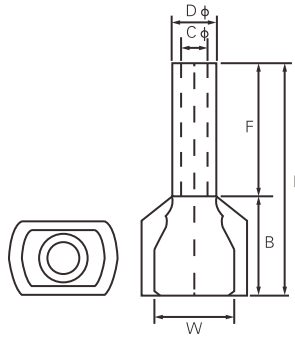

X= 0 Fransız X= F Fransız
X= 2 Alman X= A Alman

Ürün Kodu	Model Kodu	Ebatlar						Kablo Kesiti	Renk		Kutu Adet	Fiyat Adet (₺)
		F	L	W	B	DØ	CØ		Fransız	Alman		
014 100 X20508	ICYX-0508	8.0	14.5	5.0	6.5	1.8	1.5	2x0.5	Beyaz	Turuncu	1.000	1,03
014 100 X27508	ICYX-7508	8.0	14.7	5.5	6.7	2.1	1.8	2x0.75	Mavi	Beyaz	500	1,10
014 100 X21008	ICYX-1008	8.0	15.1	5.5	7.1	2.3	2.0	2x1.0	Kırmızı	Sarı	500	1,16
014 100 X21508	ICYX-1508	8.0	15.5	6.4	7.2	2.6	2.3	2x1.5	Siyah	Kırmızı	500	1,42
014 100 X22510	ICYX-2510	10.0	18.5	8.0	8.5	3.3	2.9	2x2.5	Gri	Mavi	250	2,26
014 100 X24012	ICYX-4012	12.0	23.1	8.8	11.1	4.2	3.8	2x4.0	Turuncu	Gri	200	2,63
014 100 X26014	ICYX-6014	14.0	26.1	9.5	12.1	5.3	4.9	2x6.0	Yeşil	Siyah	100	3,26
014 100 X21014	ICYX-1014	14.0	26.6	12.6	12.0	6.9	6.5	2x10.0	Kahverengi	Bej	50	4,99
014 100 X21614	ICYX-1614	14.0	31.3	19.0	17.3	8.7	8.3	2x16.0	Bej	Yeşil	50	6,30

İZOLESİZ KABLO YÜKSÜKLERİ - TEK GİRİŞ

Standart : DIN 46228
Malzeme : Bakır
Voltaj : <600V
Çalışma Sıcaklığı : Max. 105°

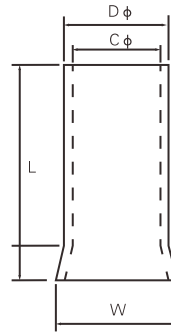

Ürün Kodu	Model Kodu	Ebatlar				Kablo Kesiti	Kutu Adet	Fiyat Adet (₺)
		L	W	DØ	CØ			
014 100 120510	KTY-0508	10.0	1.7	1.3	1.0	0.50	2.000	0,58
014 100 127510	KTY-7508	10.0	1.9	1.6	1.3	0.75	1.000	0,58
014 100 121010	KTY-1008	10.0	2.2	1.8	1.5	1.0	1.000	0,58
014 100 121510	KTY-1508	10.0	2.5	2.1	1.8	1.5	1.000	0,64
014 100 122512	KTY-2508	12.0	3.3	2.6	2.3	2.5	1.000	0,89
014 100 124012	KTY-4009	12.0	3.9	3.2	2.8	4.0	1.000	1,21
014 100 126012	KTY-6012	12.0	4.8	3.9	3.5	6.0	500	1,63
014 100 121015	KTY-1012	15.0	5.8	4.9	4.5	10.0	250	2,73
014 100 121615	KTY-1612	15.0	7.2	6.2	5.8	16.0	250	3,36
014 100 122516	KTY-2516	16.0	9.1	7.9	7.5	25.0	100	5,06
014 100 123516	KTY-3516	16.0	10.2	8.7	8.3	35.0	100	5,60
014 100 125020	KTY-5020	20.0	12.4	10.9	10.3	50.0	50	11,43

İZOLELİ YUVARLAK TİP PAPUÇ

Standart : DIN 46228
Malzeme : Bakır
İzolasyon : PVC
Voltaj : <600V
Çalışma Sıcaklığı : Max. 105°

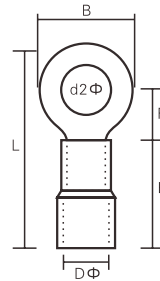

Ürün Kodu	Model Kodu	Civata Çapı (d2) mm	Ebatlar					Renk	Kablo Kesiti	Kutu Adet	Fiyat Adet (₺)
			B	F	L	E	DØ				
014 100 030153	IYP-1,5-3	3.2	5.7	4.95	17.8	10.0	4.3	Kırmızı	0.5 ~1.5 mm ² 19A	200	1,89
014 100 030154	IYP-1,5-4	4.3	8.0	7.0	21.0	10.0	4.3			200	2,73
014 100 030155	IYP-1,5-5	5.3	9.5	8.5	22.2	10.0	4.3			200	2,78
014 100 030156	IYP-1,5-6	6.5	11.6	11.1	27.0	10.0	4.3			200	4,41
014 100 030158	IYP-1,5-8	8.5	11.6	11.1	27.0	10.0	4.3			200	4,41
014 100 030253	IYP-2,5-3	3.2	6.6	4.8	17.8	10.0	4.9	Mavi	1.5 ~2.5 mm ² 27A	200	3,36
014 100 030254	IYP-2,5-4	4.3	8.5	7.4	21.7	10.0	4.9			200	3,36
014 100 030255	IYP-2,5-5	5.3	9.5	7.4	22.5	10.0	4.9			200	3,47
014 100 030256	IYP-2,5-6	6.5	12.0	11.0	27.0	10.0	4.9			200	4,94
014 100 030258	IYP-2,5-8	8.5	12.0	11.0	27.0	10.0	4.9			200	4,94
014 100 032510	IYP-2,5-10	10.5	13.6	13.9	30.7	10.0	4.9	Sarı	4 ~6 mm ² 48A	200	5,04
014 100 036004	IYP-6-4	4.3	9.5	8.3	26.0	13.0	6.7			100	7,14
014 100 036005	IYP-6-5	5.3	9.5	8.3	26.0	13.0	6.7			100	7,14
014 100 036006	IYP-6-6	6.5	12.0	10.5	29.5	13.0	6.7			100	8,09
014 100 036008	IYP-6-8	8.5	15.0	13.7	35.0	13.0	6.7			100	10,50
014 100 036010	IYP-6-10	10.5	15.0	13.7	35.0	13.0	6.7	100	10,50		
014 100 036012	IYP-6-12	13.0	19.2	16.0	39.4	13.0	6.7	100	10,71		

ÇATAL TİP İZOLELİ KABLO UÇLARI



Standart : DIN 46228
Malzeme : Bakır
İzolasyon : PVC
Voltaj : <600V
Çalışma Sıcaklığı : Max. 105°

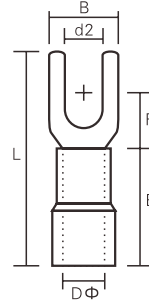

Ürün Kodu	Model Kodu	Civata Çapı (d2) mm	Ebatlar					Renk	Kablo Kesiti	Kutu Adet	Fiyat Adet (₺)
			B	F	L	H	DØ				
014 100 040153	ICP-1,5-3	3.2	5.7	6.5	21.2	10.0	4.3	Kırmızı	0.5 ~1.5 mm ² 19A	200	2,52
014 100 040154	ICP-1,5-4	4.3	8.1	6.5	21.2	10.0	4.3			200	2,57
014 100 040155	ICP-1,5-5	5.3	9.5	6.5	21.2	10.0	4.3			200	2,68
014 100 040156	ICP-1,5-6	6.5	12.0	11.0	27.2	10.0	4.3			200	3,05
014 100 040253	ICP-2,5-3	3.2	5.7	6.5	21.2	10.0	4.9	Mavi	1.5 ~2.5 mm ² 27A	200	2,78
014 100 040254	ICP-2,5-4	4.3	8.1	6.5	21.2	10.0	4.9			200	2,89
014 100 040255	ICP-2,5-5	5.3	9.5	6.5	21.2	10.0	4.9			200	2,99
014 100 040256	ICP-2,5-6	6.5	12.0	11.0	27.2	10.0	4.9			200	3,89
014 100 046004	ICP-6-4	4.3	9.0	7.5	26.5	13.0	6.7	Sarı	4 ~6 mm ² 48A	100	6,30
014 100 046005	ICP-6-5	5.3	9.0	7.5	26.5	13.0	6.7			100	6,30
014 100 046006	ICP-6-6	6.5	12.0	12.0	32.5	13.0	6.7			100	8,40
014 100 046008	ICP-6-8	8.5	14.0	11.5	31.5	13.0	6.7			100	9,98



TAM İZOLELİ FASTON DİŞİ TERMİNAL

Malzeme : Pirinç
İzolasyon : PVC
Voltaj : <600V
Çalışma Sıcaklığı : Max. 75°

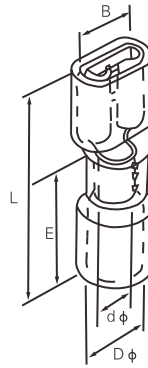

Ürün Kodu	Model Kodu	Soket Ölçüsü	Kalınlık (mm)	Ebatlar					Renk	Kablo Kesiti	Kutu Adet	Fiyat Adet (₺)
				B	DØ	dØ	L	E				
014 100 090508	TDT-0,5-1/2.8	0.5x2.8	0.30	3.3	3.8	1.7	20.0	10.0	Kırmızı	0.5 ~1.5 mm ² 10A	200	2,78
014 100 090509	TDT-0,5-1/4.8	0.8x4.75	0.35	5.0	3.8	1.7	20.5	10.0			200	3,26
014 100 090510	TDT-0,5-1/6.4	0.8x6.35	0.40	6.6	3.8	1.7	22.4	10.0			200	3,89
014 100 091523	TDT-1,5-2,5/2.8	0.8x2.8	0.30	3.3	4.3	2.3	20.0	10.0	Mavi	1.5 ~2.5 mm ² 15A	200	3,26
014 100 091524	TDT-1,5-2,5/4.8	0.8x4.75	0.35	5.0	4.3	2.3	20.5	10.0			200	3,36
014 100 091525	TDT-1,5-2,5/6.4	0.8x6.35	0.40	6.6	4.3	2.3	22.7	10.0			200	3,99
014 100 094060	TDT-4-6	0.8x6.35	0.40	6.6	5.7	3.4	23.0	12.5	Sarı	4 ~6 mm ² 24A	100	4,73

TAM İZOLELİ DİŐİ TERMİNAL

Malzeme : Pirinç
İzolasyon : PVC
Voltaj : <600V
Çalışma Sıcaklığı : Max.75°

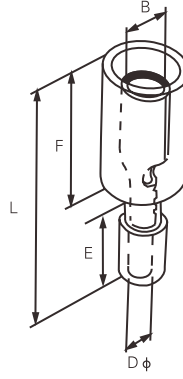

Ürün Kodu	Model Kodu	Kalınlık mm	Ebatlar					Renk	Kablo Kesiti	Kutu Adet	Fiyat Adet (₺)
			B	F	DØ	E	L				
014 100 100510	YDT-0,5-1	0.40	4.0	7.0	1.7	10.5	23.3	Kırmızı	0.5 ~1.5 mm ² 10A	200	7,77
014 100 101525	YDT-1,5-2,5	0.40	5.0	7.0	2.3	10.5	25.1	Mavi	1.5 ~2.5 mm ² 15A	100	8,82
014 100 104060	YDT-4-6	0.40	5.0	7.0	3.4	12.5	25.1	Sarı	4 ~6 mm ² 24A	100	10,92

İZOLELİ EK MUF - UZUN TİP

Standart : DIN 46237
Malzeme : Bakır / Copper
İzolasyon : PVC
Voltaj : <600V
Çalışma Sıcaklığı : Max. 75°

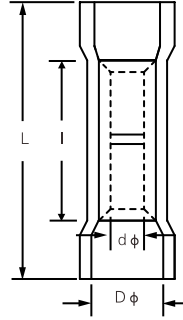

Ürün Kodu	Model Kodu	Maximum Akım	Ebatlar				Renk	Kablo Kesiti	Kutu Adet	Fiyat Adet (₺)
			l	dØ	DØ	L				
014 100 070015	IEM-1,5	19A	15.0	1.7	4.3	25.0	Kırmızı	0.5 ~1.5 mm ²	200	3,89
014 100 070025	IEM-2,5	27A	15.0	2.3	4.9	25.0	Mavi	1.5 ~2.5 mm ²	200	3,89
014 100 070040	IEM-4	48A	15.0	3.4	6.7	25.0	Sarı	4 ~6 mm ²	100	6,56

İZOLELİ İÇNE TİP TERMİNAL

Malzeme : Bakır
İzolasyon : PVC
Voltaj : <600V
Çalışma Sıcaklığı : Max. 75°

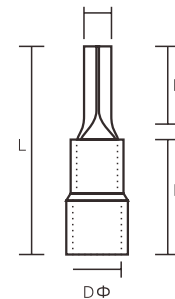

Ürün Kodu	Model Kodu	Kalınlık mm	Ebatlar					Renk	Kablo Kesiti	Kutu Adet	Fiyat Adet (₺)
			B	F	L	E	DØ				
014 100 050015	IIT-1,5	0.7	1.9	10.0	20.0	10.0	4.3	Kırmızı	0.5 ~1.5 mm ² 19A	200	2,94
014 100 050025	IIT-2,5	0.8	1.9	12.0	22.0	10.0	4.9	Mavi	1.5 ~2.5 mm ² 27A	200	3,57
014 100 050040	IIT-4	1.0	2.8	13.0	26.8	13.0	6.7	Sarı	4 ~6 mm ² 48A	100	8,40

İZOLELİ FASTON ERKEK TERMİNAL

Malzeme : Pirinç
İzolasyon : PVC
Voltaj : <600V
Çalışma Sıcaklığı : Max. 75°

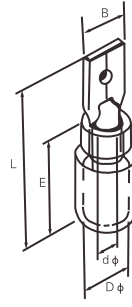

Ürün Kodu	Model Kodu	Soket Ölçüsü	Kalınlık (mm)	Ebatlar					Renk	Kablo Kesiti	Kutu Adet	Fiyat Adet (₺)
				B	DØ	dØ	L	E				
014 100 060013	IFE-1,5/2.8	0.8x2.8	0.8	2.8	1.7	3.8	17.7	10.0	Kırmızı	0.5 ~1.5 mm ² 10A	200	1,84
014 100 060014	IFE-1,5/4.8	0.4x4.75	0.4x2	4.8	1.7	3.8	20.0	10.0			200	2,10
014 100 060015	IFE-1,5/6.4	0.8x6.35	0.4x2	6.4	1.7	3.8	21.0	10.0			200	2,63
014 100 060023	IFE-2,5/2.8	0.8x2.8	0.8	2.8	2.3	4.3	17.7	10.0	Mavi	1.5 ~2.5 mm ² 15A	200	1,84
014 100 060024	IFE-2,5/4.8	0.4x4.75	0.4x2	4.8	2.3	4.3	20.0	10.0			200	2,36
014 100 060025	IFE-2,5/6.4	0.8x6.35	0.4x2	6.4	2.3	4.3	21.0	10.0			200	2,78
014 100 060040	IFE-4	0.8x6.35	0.4x2	6.4	3.4	5.7	23.0	12.5	Sarı	4 ~6 mm ² 24A	200	3,26

YUVARLAK ERKEK TERMİNAL

Malzeme : Pirinç
İzolasyon : PVC
Voltaj : <600V
Çalışma Sıcaklığı : Max. 75°

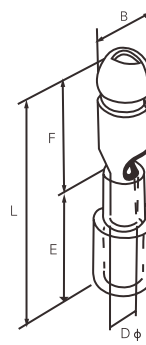

Ürün Kodu	Model Kodu	Kalınlık mm	Ebatlar					Renk	Kablo Kesiti	Kutu Adet	Fiyat Adet (₺)
			B	F	DØ	E	L				
014 100 110510	YET-0,5-1	0.4	4.0	8.5	1.7	10.5	21.5	Kırmızı	0.5 ~1.5 mm ² 10A	200	6,51
014 100 111525	YET-1,5-2,5	0.4	5.0	8.5	2.3	10.5	21.7	Mavi	1.5 ~2.5 mm ² 15A	200	7,46
014 100 114060	YET-4-6	0.4	5.0	8.5	3.4	13.0	24.0	Sarı	4 ~6 mm ² 24A	200	9,87

İZOLELİ ERKEK - DİŞİ TERMİNAL

Malzeme : Pirinç
İzolasyon : PVC
Voltaj : <600V
Çalışma Sıcaklığı : Max. 75°

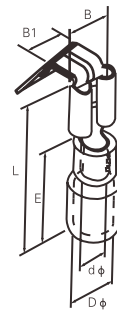

Ürün Kodu	Model Kodu	Soket Ölçüsü	Ebatlar						Renk	Kablo Kesiti	Kutu Adet	Fiyat Adet (₺)
			B	B1	E	DØ	dØ	L				
014 100 130515	IEDT-0,5-1,5	0.8x6.35	6.6	6.35	10.0	3.8	1.7	22.5	Kırmızı	0.5 ~1.5 mm ² 10A	100	5,36
014 100 131525	IEDT-1,5-2,5	0.8x6.35	6.6	6.35	10.0	4.3	2.3	22.5	Mavi	1.5 ~2.5 mm ² 15A	100	5,88
014 100 134060	IEDT-4-6	0.8x6.35	6.6	6.35	13.0	5.7	3.4	24.0	Sarı	4 ~6 mm ² 24A	100	6,41

İZOLELİ TAM DIŞI TERMİNAL

Malzeme : Bakır
İzolasyon : PVC
Voltaj : <600V
Çalışma Sıcaklığı : Max. 75°

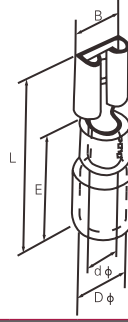

Ürün Kodu	Model Kodu	Soket Ölçüsü	Kalınlık (mm)	Ebatlar					Renk	Kablo Kesiti	Kutu Adet	Fiyat Adet (₺)
				B	DØ	dØ	L	E				
014 100 080508	IDT-0,5-1/2.8	0.8x2.8	0.3	3.3	3.8	1.7	18.5	10.0	Kırmızı	0.5 ~1.5 mm ² 10A	200	1,68
014 100 080509	IDT-0,5-1/4.8	0.8x4.75	0.35	5.0	3.8	1.7	19.0	10.0			200	2,21
014 100 080510	IDT-0,5-1/6.4	0.8x6.35	0.4	6.6	3.8	1.7	19.8	10.0			200	2,89
014 100 081523	IDT-1,5-2,5/2.8	0.8x2.8	0.3	3.3	4.3	2.3	18.5	10.0	Mavi	1.5 ~2.5 mm ² 15A	200	2,21
014 100 081524	IDT-1,5-2,5/4.8	0.8x4.75	0.35	5.0	4.3	2.3	19.0	10.0			200	2,31
014 100 081525	IDT-1,5-2,5/6.4	0.8x6.35	0.4	6.6	4.3	2.3	19.0	10.0			200	2,89
014 100 084060	IDT-4-6	0.8x6.35	0.4	6.6	5.7	3.4	23.4	12.5	Sarı	4 ~6 mm ² 24A	100	3,26

TAM İZOLELİ FASTON EĞİK DIŞI TERMİNAL

Malzeme : Piriç
İzolasyon : Nylon
Voltaj : <600V
Sıcaklık : 105° 400V

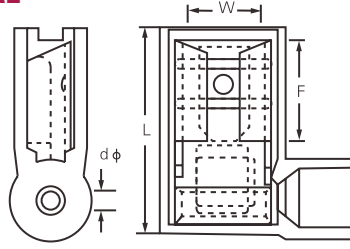

Ürün Kodu	Model Kodu	Soket Ölçüsü	Ebatlar				Renk	Kablo Kesiti	Kutu Adet	Fiyat Adet (₺)
			W	F	L	dØ				
014 100 140515	TEDT-0,5-1,5	0.8x4.75	6.6	7.6	16.0	1.7	Kırmızı	0.5 ~1.5 mm ² 10A	100	7,35
014 100 141525	TEDT-1,5-2,5	0.8x6.35	6.6	7.6	16.0	2.3	Mavi	1.5 ~2.5 mm ² 15A	100	7,35
014 100 144060	TEDT-4-6	0.8x6.35	7.0	7.6	17.5	3.4	Sarı	4 ~6 mm ² 24A	100	23,18

POLYAMİD TAM İZOLELİ DIŞI TERMİNAL

Malzeme : Piriç
İzolasyon : Nylon
Voltaj : <600V
Sıcaklık : 105° 400V

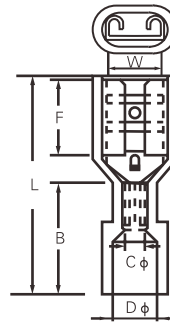

Ürün Kodu	Model Kodu	Soket Ölçüsü	Ebatlar						Renk	Kutu Adet	Fiyat Adet (₺)
			W	F	L	B	DØ	CØ			
014 100 150510	TDTP-0,5-1/6.4	0.8x6.35	8.4	10.5	22.6	11.0	4.0	1.7	Kırmızı	200	7,41
014 100 151525	TDTP-1,5-2,5/6.4	0.8x6.35	8.4	10.5	22.6	11.0	4.5	2.3	Mavi	200	7,41
014 100 154060	TDTP-4-6	0.8x6.35	8.6	10.5	24.0	13.0	6.3	3.4	Sarı	100	9,26



TOPRAKLAMA BARASI VE MESNEDİ

Ürün Kodu	Ürün Adı	Adet	Fiyat (₺)
034 025 040000	TOPRAKLAMA BARASI 1,5 mm (31 VİDA)	40	1.387,65
034 025 100001	TOPRAKLAMA BARASI MESNEDİ	100	32,41

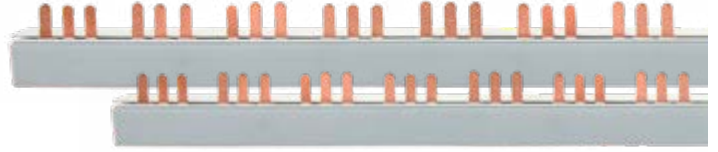

TRİFAZE BARALAR

Ürün Kodu	Ürün Adı	Adet	Fiyat (₺)
034 025 040004	TRİFAZE MÜŞTEREK BARA İĞNE UÇLU 80A - 53 cm	24	1.224,90
034 025 040005	TRİFAZE MÜŞTEREK BARA İĞNE UÇLU 63A - 53 cm	24	985,06
034 025 040006	TRİFAZE MÜŞTEREK BARA İĞNE UÇLU 80A - 106 cm	24	2.449,80
034 025 040007	TRİFAZE MÜŞTEREK BARA İĞNE UÇLU 63A - 106 cm	24	1.970,12



MONOFAZE BARALAR

Ürün Kodu	Ürün Adı	Adet	Fiyat (₺)
034 025 040002	MONOFAZE MÜŞTEREK BARA İĞNE UÇLU 106 cm	50	849,72
034 025 040003	MONOFAZE MÜŞTEREK BARA İĞNE UÇLU 53 cm	50	424,86



250 MİKRON BAKIR KAPLAMA TOPRAKLAMA ÇUBUĞU

Ürün Kodu	Ürün Adı	Adet	Fiyat (₺)
091 025 011610	16 mm 1 m TOPRAKLAMA ÇUBUĞU 250 MİKRON BAKIR KAPLAMA	10 ad.	1.151,94
091 025 011615	16 mm 1,5 m TOPRAKLAMA ÇUBUĞU 250 MİKRON BAKIR KAPLAMA	10 ad.	1.651,12
091 025 012010	20 mm 1 m TOPRAKLAMA ÇUBUĞU 250 MİKRON BAKIR KAPLAMA	5 ad.	1.651,12
091 025 012015	20 mm 1,5 m TOPRAKLAMA ÇUBUĞU 250 MİKRON BAKIR KAPLAMA	5 ad.	2.419,08

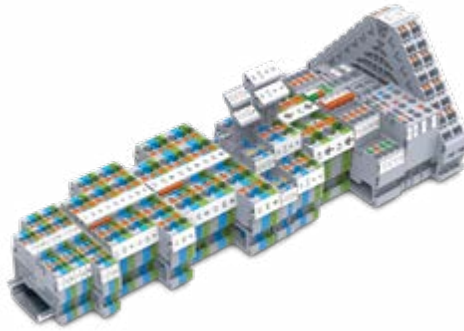

RAYLAR

Ürün Kodu	Ürün Adı	Adet	Fiyat (₺)
001 025 020100 00 00	KLEMENS RAYI(1m)	25 m	203,70
001 025 000100 00 00	W OTOMAT RAYI (1m) (1m Fiyatı)	50 m	100,00
001 025 000200 00 00	W OTOMAT RAYI (2m) (1m Fiyatı)	50 m	100,00
001 025 000033 00 00	W OTOMAT RAYI (33 cm)	50 m	35,19
001 025 900100 00 00	W OTOMAT RAYI(DELİKLİ)(1m)(1m Fiyatı)	50 m	111,11
001 025 900200 00 00	W OTOMAT RAYI(DELİKLİ)(2m)(1m Fiyatı)	50 m	111,11

EKO KABLO PABUÇLARI

Ürün Kodu	Ürün Adı	Civata	D3	D2	D1	L	A	Kutu Adet	Fiyat (₺)
123 037 000016	16-06 EKO TİP KABLO PABUCU	M6	6,5	5,8	7,4	30	12	500	28,27
123 037 000025	25-08 EKO TİP KABLO PABUCU	M8	8,5	7	9,2	40	14	350	46,26
123 037 000035	35-08 EKO TİP KABLO PABUCU	M8	8,5	8,2	10,7	44	15,3	200	64,24
123 037 000050	50-10 EKO TİP KABLO PABUCU	M10	10,5	10,2	12,8	52	20	150	82,23
123 037 000070	70-10 EKO TİP KABLO PABUCU	M10	10,5	11,7	14,7	55	22	100	148,19
123 037 000095	95-12 EKO TİP KABLO PABUCU	M12	13	13,6	16,7	59	26	70	166,18
123 037 000120	120-12 EKO TİP KABLO PABUCU	M12	13	15,5	19	70	29	50	228,71
123 037 000150	150-12 EKO TİP KABLO PABUCU	M12	13	16,7	21	77	32	40	349,48
123 037 000185	185-16 EKO TİP KABLO PABUCU	M16	17	18,8	23	85	35	30	422,29
123 037 000240	240-16 EKO TİP KABLO PABUCU	M16	17	21,2	26	90	38,5	24	645,86

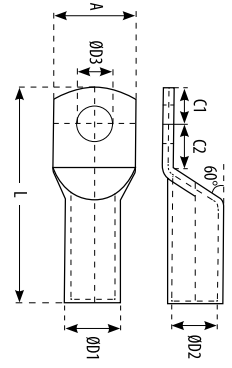

STANDART KABLO PABUÇLARI



Ürün Kodu	Ürün Adı	Civata	D3	D2	D1	L	A	Kutu Adet	Fiyat (₺)
123 037 500010	10-05 STANDART TİP KABLO PABUCU	M5	5,2	4,7	6,5	27,5	10,5	800	27,41
123 037 500011	10-06 STANDART TİP KABLO PABUCU	M6	6,5	4,7	6,5	27,5	10,5	800	27,41
123 037 500012	10-08 STANDART TİP KABLO PABUCU	M8	8,5	4,7	6,5	27,5	10,5	800	27,41
123 037 500016	16-06 STANDART TİP KABLO PABUCU	M6	6,5	5,8	7,4	30	12	500	41,12
123 037 500017	16-08 STANDART TİP KABLO PABUCU	M8	8,5	5,8	7,8	30	12	500	41,12
123 037 500018	16-10 STANDART TİP KABLO PABUCU	M10	10,5	5,8	7,8	30	12	500	41,12
123 037 500024	25-06 STANDART TİP KABLO PABUCU	M6	6,5	7	9,2	40	14	350	68,53
123 037 500025	25-08 STANDART TİP KABLO PABUCU	M8	8,5	7	9,2	40	14	350	68,53
123 037 500026	25-10 STANDART TİP KABLO PABUCU	M10	10,5	7	9,5	40	14	350	68,53
123 037 500034	35-06 STANDART TİP KABLO PABUCU	M6	6,5	8,2	10,7	44	15,3	200	94,22
123 037 500035	35-08 STANDART TİP KABLO PABUCU	M8	8,5	8,2	10,7	44	15,3	200	94,22
123 037 500036	35-10 STANDART TİP KABLO PABUCU	M10	10,5	8,2	10,7	44	15,3	200	94,22
123 037 500037	35-12 STANDART TİP KABLO PABUCU	M12	13	8,2	10,7	44	15,3	200	94,22
123 037 500049	50-08 STANDART TİP KABLO PABUCU	M8	8,5	10,2	12,8	52	20	150	143,05
123 037 500050	50-10 STANDART TİP KABLO PABUCU	M10	10,5	10,2	12,8	52	20	150	143,05
123 037 500051	50-12 STANDART TİP KABLO PABUCU	M12	13	10,2	12,8	52	20	150	143,05
123 037 500069	70-08 STANDART TİP KABLO PABUCU	M8	8,5	11,7	14,7	55	22	100	179,88
123 037 500070	70-10 STANDART TİP KABLO PABUCU	M10	10,5	11,7	14,7	55	22	100	179,88
123 037 500071	70-12 STANDART TİP KABLO PABUCU	M12	13	11,7	14,7	55	22	100	179,88
123 037 500094	95-10 STANDART TİP KABLO PABUCU	M10	10,5	13,6	16,7	59	26	70	221,85
123 037 500095	95-12 STANDART TİP KABLO PABUCU	M12	13	13,6	16,7	59	26	70	221,85
123 037 500119	120-10 STANDART TİP KABLO PABUCU	M10	10,5	15,5	19	70	29	50	334,06
123 037 500120	120-12 STANDART TİP KABLO PABUCU	M12	13	15,5	19	70	29	50	334,06
123 037 500149	150-10 STANDART TİP KABLO PABUCU	M10	10,5	16,7	21	77	32	40	525,94
123 037 500150	150-12 STANDART TİP KABLO PABUCU	M12	13	16,7	21	77	32	40	525,94
123 037 500183	185-10 STANDART TİP KABLO PABUCU	M10	10,5	18,8	23	85	35	30	620,16
123 037 500184	185-12 STANDART TİP KABLO PABUCU	M12	13	18,8	23	85	35	30	620,16
123 037 500185	185-16 STANDART TİP KABLO PABUCU	M16	17	18,8	23	85	35	30	620,16
123 037 500238	240-10 STANDART TİP KABLO PABUCU	M10	10,5	21,2	26	90	38,5	24	829,16
123 037 500239	240-12 STANDART TİP KABLO PABUCU	M12	13	21,2	26	90	38,5	24	829,16
123 037 500240	240-16 STANDART TİP KABLO PABUCU	M16	17	21,2	26	90	38,5	24	829,16
123 037 500299	300-12 STANDART TİP KABLO PABUCU	M12	13	23,5	28,6	100	43	20	1.086,14
123 037 500300	300-16 STANDART TİP KABLO PABUCU	M16	17	23,5	28,6	100	43	20	1.086,14



BORU TİP SIKMALI EK MUFLAR

Ürün Kodu	Ürün Adı	D2	D3	L	Kutu Adet	Fiyat (₺)
123 037 300016	16 mm ² BORU TİP SIKMALI EK MUF	5,8	7,4	30	500	28,27
123 037 300025	25 mm ² BORU TİP SIKMALI EK MUF	7,2	9,2	40	300	49,68
123 037 300035	35 mm ² BORU TİP SIKMALI EK MUF	8,5	11	44	200	67,67
123 037 300050	50 mm ² BORU TİP SIKMALI EK MUF	10	13	52	150	87,37
123 037 300070	70 mm ² BORU TİP SIKMALI EK MUF	11,5	14,7	55	100	158,47
123 037 300095	95 mm ² BORU TİP SIKMALI EK MUF	13,5	16,7	59	70	175,60
123 037 300120	120 mm ² BORU TİP SIKMALI EK MUF	15,6	19	70	50	241,55
123 037 300150	150 mm ² BORU TİP SIKMALI EK MUF	17	21	77	40	373,47
123 037 300185	185 mm ² BORU TİP SIKMALI EK MUF	19	23	85	30	457,41
123 037 300240	240 mm ² BORU TİP SIKMALI EK MUF	21	26	90	24	685,26



KOLAY MONTAJ
İSTER FİŞ OLSUN İSTER PRİZ!!
DUVARDAN, MAKİNADAN
SÖKMEDEN TEK TUŞLA DEĞİŞİM
YAPABİLİRSİNİZ...

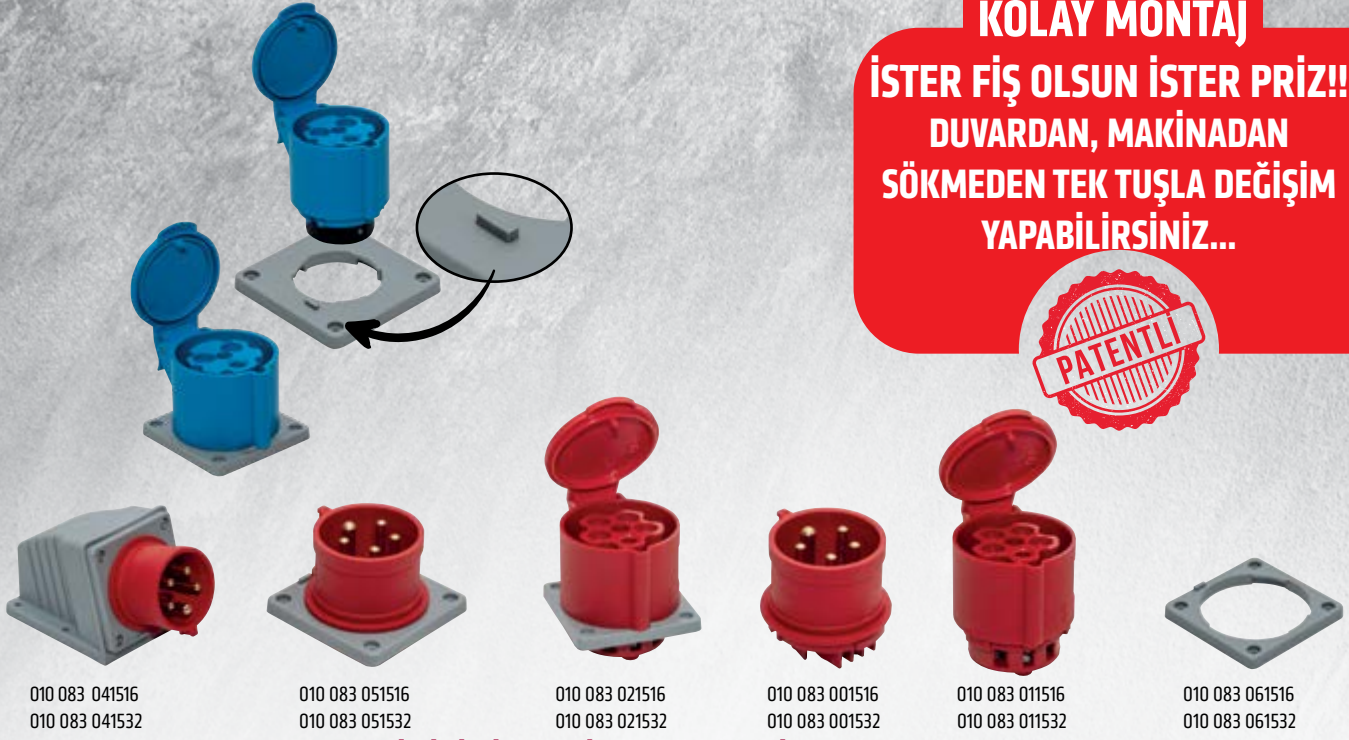

010 083 041516
010 083 041532

010 083 051516
010 083 051532

010 083 021516
010 083 021532

010 083 001516
010 083 001532

010 083 011516
010 083 011532

010 083 061516
010 083 061532

MUTLUSAN CEE NORM SANAYİ TİPİ FİŞ - PRİZ GRUBU (TRİFAZE)



Ürün Kodu	Ürün Adı	Kutu / Adet	Koli / Adet	Fiyat (₺)
010 083 041516	MUT-105 CEE NORM 5X16A DUVAR FİŞİ (TUŞ KİLİTLİ)	8	64	644,83
010 083 051516	MUT-106 CEE NORM 5X16A MAKİNE FİŞİ (TUŞ KİLİTLİ)	20	160	507,62
010 083 021516	MUT-107 CEE NORM 5X16A MAKİNE PRİZİ (TUŞ KİLİTLİ)	20	160	570,88
010 083 001516	MUT-108 CEE NORM 5X16A DÜZ FİŞ ÜST MEKANİZMA	25	200	384,76
010 083 011516	MUT-109 CEE NORM 5X16A UZATMA PRİZİ ÜST MEKANİZMA	25	200	456,49
010 083 061516	MUT-116 CEE NORM 5X16A TUŞ KİLİTLİ FİŞ PRİZ APARATI	25	750	130,43
010 083 041532	MUT-205 CEE NORM 5X32A DUVAR FİŞİ (TUŞ KİLİTLİ)	8	64	824,95
010 083 051532	MUT-206 CEE NORM 5X32A MAKİNE FİŞİ (TUŞ KİLİTLİ)	20	160	680,31
010 083 021532	MUT-207 CEE NORM 5X32A MAKİNE PRİZİ (TUŞ KİLİTLİ)	20	160	686,30
010 083 001532	MUT-208 CEE NORM 5X32A DÜZ FİŞ ÜST MEKANİZMA	25	200	521,71
010 083 011532	MUT-209 CEE NORM 5X32A UZATMA PRİZİ ÜST MEKANİZMA	25	200	554,31
010 083 061532	MUT-216 CEE NORM 5X32A TUŞ KİLİTLİ FİŞ PRİZ APARATI	25	750	130,43



010 083 041416
010 083 041432

010 083 051416
010 083 051432

010 083 021416
010 083 021432

010 083 001416
010 083 001432

010 083 011416
010 083 011432

010 083 061416
010 083 061432

MUTLUSAN CEE NORM SANAYİ TİPİ FİŞ - PRİZ GRUBU (TRİFAZE)



Ürün Kodu	Ürün Adı	Kutu / Adet	Koli / Adet	Fiyat (₺)
010 083 041416	MUT-405 CEE NORM 4X16A DUVAR FİŞİ (TUŞ KİLİTLİ)	8	64	670,59
010 083 051416	MUT-406 CEE NORM 4X16A MAKİNE FİŞİ (TUŞ KİLİTLİ)	20	160	473,25
010 083 021416	MUT-407 CEE NORM 4X16A MAKİNE PRİZİ (TUŞ KİLİTLİ)	20	160	526,53
010 083 001416	MUT-408 CEE NORM 4X16A DÜZ FİŞ ÜST MEKANİZMA	30	240	320,33
010 083 011416	MUT-409 CEE NORM 4X16A UZATMA PRİZİ ÜST MEKANİZMA	30	240	433,02
010 083 061416	MUT-416 CEE NORM 4X16A TUŞ KİLİTLİ FİŞ PRİZ APARATI	30	900	130,43
010 083 041432	MUT-450 CEE NORM 4X32A DUVAR FİŞİ (TUŞ KİLİTLİ)	8	64	766,26
010 083 051432	MUT-460 CEE NORM 4X32A MAKİNE FİŞİ (TUŞ KİLİTLİ)	20	160	650,76
010 083 021432	MUT-470 CEE NORM 4X32A MAKİNE PRİZİ (TUŞ KİLİTLİ)	20	160	624,09
010 083 001432	MUT-480 CEE NORM 4X32A DÜZ FİŞ ÜST MEKANİZMA	25	200	489,36
010 083 011432	MUT-490 CEE NORM 4X32A UZATMA PRİZİ ÜST MEKANİZMA	25	200	548,84
010 083 061432	MUT-432 CEE NORM 4X32A TUŞ KİLİTLİ FİŞ PRİZ APARATI	25	750	130,43



010 083 041316
010 083 041332

010 083 051316
010 083 051332

010 083 021316
010 083 021332

010 083 001316
010 083 001332

010 083 011316
010 083 011332

010 083 061316
010 083 061332

MUTLUSAN CEE NORM SANAYİ TİPİ FİŞ - PRİZ GRUBU (MONOFAZE)



Ürün Kodu	Ürün Adı	Kutu / Adet	Koli / Adet	Fiyat (₺)
010 083 041316	MUT-305 CEE NORM 16A DUVAR FİŞİ (TUŞ KİLİTLİ)	8	64	565,27
010 083 051316	MUT-306 CEE NORM 16A MAKİNE FİŞİ (TUŞ KİLİTLİ)	20	160	384,50
010 083 021316	MUT-307 CEE NORM 16A MAKİNE PRİZİ (TUŞ KİLİTLİ)	20	160	422,13
010 083 001316	MUT-308 CEE NORM 16A DÜZ FİŞ ÜST MEKANİZMA	30	240	235,81
010 083 011316	MUT-309 CEE NORM 16A UZATMA PRİZİ ÜST MEKANİZMA	30	240	271,61
010 083 061316	MUT-316 CEE NORM 16A TUŞ KİLİTLİ FİŞ PRİZ APARATI	30	750	130,43
010 083 041332	MUT-350 CEE NORM 32A DUVAR FİŞİ (TUŞ KİLİTLİ)	8	64	689,50
010 083 051332	MUT-360 CEE NORM 32A MAKİNE FİŞİ (TUŞ KİLİTLİ)	20	160	579,81
010 083 021332	MUT-370 CEE NORM 32A MAKİNE PRİZİ (TUŞ KİLİTLİ)	20	160	544,27
010 083 001332	MUT-380 CEE NORM 32A DÜZ FİŞ ÜST MEKANİZMA	25	200	421,80
010 083 011332	MUT-390 CEE NORM 32A UZATMA PRİZİ ÜST MEKANİZMA	25	200	461,51
010 083 061332	MUT-332 CEE NORM 32A TUŞ KİLİTLİ FİŞ PRİZ APARATI	25	750	130,43



010 083 071563
010 083 081563

010 083 091563
010 083 011563

010 083 021563
010 083 101563

010 083 051563
010 083 111563

MUTLUSAN CEE NORM SANAYİ TİPİ FİŞ - PRİZ GRUBU (TRİFAZE - IP44)



Ürün Kodu	Ürün Adı	Kutu / Adet	Koli / Adet	Fiyat (₺)
010 083 071563	MUT-501 CEE NORM 5X63A ERKEK FİŞ IP44	4	32	2.328,12
010 083 011563	MUT-502 CEE NORM 5X63A UZATMA PRİZİ IP44	4	32	3.012,86
010 083 021563	MUT-503 CEE NORM 5X63A MAKİNE PRİZİ IP44	6	48	2.491,08
010 083 051563	MUT-504 CEE NORM 5X63A MAKİNE FİŞİ IP44	6	48	2.491,08
010 083 081563	MUT-509 CEE NORM 5X63A ERKEK FİŞ PİLOTLU IP44	4	32	2.444,52
010 083 091563	MUT-510 CEE NORM 5X63A UZATMA PRİZİ PİLOTLU IP44	4	32	3.163,50
010 083 101563	MUT-511 CEE NORM 5X63A MAKİNE PRİZİ PİLOTLU IP44	6	48	2.615,64
010 083 111563	MUT-512 CEE NORM 5X63A MAKİNE FİŞİ PİLOTLU IP44	6	48	2.615,64



010 083 092563
010 083 012563

010 083 072563
010 083 082563

010 083 072563
010 083 082563

010 083 052563
010 083 112563

MUTLUSAN CEE NORM SANAYİ TİPİ FİŞ - PRİZ GRUBU (TRİFAZE - IP67)



Ürün Kodu	Ürün Adı	Kutu / Adet	Koli / Adet	Fiyat (₺)
010 083 072563	MUT-505 CEE NORM 5X63A ERKEK FİŞ IP67	4	32	2.584,21
010 083 012563	MUT-506 CEE NORM 5X63A UZATMA PRİZİ IP67	4	32	3.223,75
010 083 022563	MUT-507 CEE NORM 5X63A MAKİNE PRİZİ IP67	6	48	2.864,75
010 083 052563	MUT-508 CEE NORM 5X63A MAKİNE FİŞİ IP67	6	48	2.864,75
010 083 082563	MUT-513 CEE NORM 5X63A ERKEK FİŞ PİLOTLU IP67	4	32	2.713,42
010 083 092563	MUT-514 CEE NORM 5X63A UZATMA PRİZİ PİLOTLU IP67	4	32	3.384,94
010 083 102563	MUT-515 CEE NORM 5X63A MAKİNE PRİZİ PİLOTLU IP67	6	48	3.007,98
010 083 112563	MUT-516 CEE NORM 5X63A MAKİNE FİŞİ PİLOTLU IP67	6	48	3.007,98



010 083 000516
010 083 000532



010 083 010516
010 083 010532



010 083 020516
010 083 020532



010 083 030516
010 083 030532

MUTLUSAN CEE NORM SANAYİ TİPİ FİŞ - PRİZ GRUBU (TRİFAZE)



Ürün Kodu	Ürün Adı	Kutu / Adet	Koli / Adet	Fiyat (₺)
010 083 000516	MUT-101 CEE NORM 5x16A DÜZ FİŞ	16	128	442,03
010 083 010516	MUT-102 CEE NORM 5x16A UZATMA PRİZİ	15	120	561,55
010 083 020516	MUT-103 CEE NORM 5x16A MAKİNE PRİZİ	20	160	497,19
010 083 030516	MUT-104 CEE NORM 5x16A DUVAR PRİZİ	8	64	618,91
010 083 000532	MUT-201 CEE NORM 5x32A DÜZ FİŞ	14	112	592,46
010 083 010532	MUT-202 CEE NORM 5x32A UZATMA PRİZİ	12	96	686,91
010 083 020532	MUT-203 CEE NORM 5x32A MAKİNE PRİZİ	14	112	597,61
010 083 030532	MUT-204 CEE NORM 5x32A DUVAR PRİZİ	8	64	718,72



010 083 000416
010 083 000432



010 083 010416
010 083 010432



010 083 020416
010 083 020432



010 083 030416
010 083 030432

MUTLUSAN CEE NORM SANAYİ TİPİ FİŞ - PRİZ GRUBU (TRİFAZE)



Ürün Kodu	Ürün Adı	Kutu / Adet	Koli / Adet	Fiyat (₺)
010 083 000416	MUT-401 CEE NORM 4/16A DÜZ FİŞ	16	128	412,15
010 083 010416	MUT-402 CEE NORM 4/16A UZATMA PRİZ	15	120	515,19
010 083 020416	MUT-403 CEE NORM 4/16A MAKİNE PRİZİ	20	160	458,51
010 083 030416	MUT-404 CEE NORM 4/16A DUVAR PRİZİ	8	64	583,88
010 083 000432	MUT-410 CEE NORM 4/32A DÜZ FİŞ	14	112	566,70
010 083 010432	MUT-420 CEE NORM 4/32A UZATMA PRİZ	12	96	620,97
010 083 020432	MUT-430 CEE NORM 4/32A MAKİNE PRİZİ	14	112	543,55
010 083 030432	MUT-440 CEE NORM 4/32A DUVAR PRİZİ	8	64	667,20



010 083 000316
010 083 000332



010 083 010316
010 083 010332



010 083 020316
010 083 020332



010 083 030316
010 083 030332

MUTLUSAN CEE NORM SANAYİ TİPİ FİŞ - PRİZ GRUBU (MONOFAZE)



Ürün Kodu	Ürün Adı	Kutu / Adet	Koli / Adet	Fiyat (₺)
010 083 000316	MUT-301 CEE NORM 16A DÜZ FİŞ	16	128	334,87
010 083 010316	MUT-302 CEE NORM 16A UZATMA PRİZ	15	120	389,00
010 083 020316	MUT-303 CEE NORM 16A MAKİNE PRİZİ	20	160	367,50
010 083 030316	MUT-304 CEE NORM 16A DUVAR PRİZİ	8	64	492,17
010 083 000332	MUT-310 CEE NORM 32A DÜZ FİŞ	12	112	504,88
010 083 010332	MUT-320 CEE NORM 32A UZATMA PRİZ	12	96	541,29
010 083 020332	MUT-330 CEE NORM 32A MAKİNE PRİZİ	14	112	473,97
010 083 030332	MUT-340 CEE NORM 32A DUVAR PRİZİ	8	64	600,36



010 083 500298



010 083 501297



010 083 500297



010 083 500299



010 083 502910

MUTLUSAN SANAYİ TİPİ FİŞ - PRİZ GRUBU (MONOFAZE)

CE

Ürün Kodu	Ürün Adı	Kutu / Adet	Koli / Adet	Fiyat (₺)
010 083 500298	MUT-29/8 MONOFAZE 16A TOPRAKLI PANO PRİZİ	40	320	105,47
010 083 501297	MUT-29/8-U MONOFAZE 16A UPS TOPRAKLI PANO PRİZİ	40	320	128,80
010 083 500297	MUT-29/7 MONOFAZE 16A DUVAR PRİZİ	30	240	170,11
010 083 500299	MUT-29/9 MONOFAZE 16A MAKİNE PRİZİ	20	160	214,34
010 083 502910	MUT-29/10 MONOFAZE 16A DUVAR PRİZİ	15	120	284,66

010 083 400064
010 083 400318
010 083 400074



010 083 400063
010 083 400319
010 083 400073



MUTLUSAN SANAYİ TİPİ FİŞ - PRİZ GRUBU (MONOFAZE)

CE

Ürün Kodu	Ürün Adı	Kutu / Adet	Koli / Adet	Fiyat (₺)
010 083 400064	MUT-64 16A MONOFAZE MAKİNE PRİZİ	20	160	341,36
010 083 400063	MUT-63 16A MONOFAZE DUVAR PRİZİ	12	96	382,19
010 083 400318	MUT-31/8 25A MONOFAZE MAKİNE PRİZİ	20	160	286,90
010 083 400319	MUT-31/9 25A MONOFAZE DUVAR PRİZİ	15	120	365,77
010 083 400074	MUT-74 32A MONOFAZE MAKİNE PRİZİ	20	160	419,49
010 083 400073	MUT-73 32A MONOFAZE DUVAR PRİZİ	12	96	491,50



010 083 300027



010 083 300028



010 083 300029



010 083 301029



010 083 500296



010 083 502294



010 083 500293



010 083 500294



010 083 501292



010 083 501293



010 083 500292

MUTLUSAN KAUÇUK SANAYİ TİPİ FİŞ - PRİZ GRUBU (MONOFAZE)

CE

Ürün Kodu	Ürün Adı	Kutu / Adet	Koli / Adet	Fiyat (₺)
010 083 300027	MUT-27 16A MONOFAZE TOPRAKLI ERKEK FİŞ (EĞİK)	40	320	100,46
010 083 300028	MUT-28 16A MONOFAZE TOPRAKLI ERKEK FİŞ (DÜZ)	40	320	100,46
010 083 300029	MUT-29 16A MONOFAZE TOPRAKLI DIŞI FİŞ	25	200	154,56
YENİ 010 083 301029	OLİMPİA MUT-29 16A MONOFAZE TOPRAKLI DIŞI FİŞ	25	200	127,31
010 083 500296	MUT-29/6 16A MONOFAZE TOPRAKLI DUVAR PRİZ	20	160	195,77
010 083 500293	MUT-29/3 16A MONOFAZE 3'LÜ GRUP PRİZ	12	96	311,69
YENİ 010 083 502293	OLİMPİA MUT-29/3 16A MONOFAZE 3'LÜ GRUP PRİZ	12	96	266,20
010 083 500294	MUT-29/4 16A MONOFAZE 4'LÜ GRUP PRİZ	10	80	396,93
010 083 501292	MUT-29/2A 16A MONOFAZE 2'Lİ GRUP PRİZ ANAHTARLI	12	96	568,76
010 083 501293	MUT-29/3A 16A MONOFAZE 3'LÜ GRUP PRİZ ANAHTARLI	10	80	654,70
010 083 500292	MUT-29/2 16A MONOFAZE 2'Lİ GRUP PRİZ	14	112	243,85



010 083 400030 010 083 400031 010 083 600315 010 083 600311 010 083 600312 010 083 600313 010 083 600316 010 083 600317

MUTLUSAN KAUCUK SANAYİ TIPI FİŞ - PRİZ GRUBU (TRİFAZE)

CE

Ürün Kodu	Ürün Adı	Kutu / Adet	Koli / Adet	Fiyat (₺)
010 083 400030	MUT-30 25A TRİFAZE ERKEK FİŞ	25	200	195,77
010 083 400031	MUT-31 25A TRİFAZE DIŞI FİŞ (SEYYAR)	20	160	308,62
010 083 600315	MUT-31/5 25A TRİFAZE DUVAR PRİZ	20	160	365,77
010 083 600311	MUT-31/1 1 TRİFAZE + 1 MONOFAZE GRUP PRİZ	10	80	664,67
010 083 600312	MUT-31/2 TRİFAZE GRUP PRİZ - 2'Lİ	10	80	736,04
010 083 600313	MUT-31/3 TRİFAZE GRUP PRİZ - 3'LÜ	10	80	839,08
010 083 600316	MUT-31/6 2 TRİFAZE + 1 MONOFAZE GRUP PRİZ	10	80	839,08
010 083 600317	MUT-31/7 1 TRİFAZE + 2 MONOFAZE GRUP PRİZ	10	80	839,08



010 083 400060
010 083 400070

010 083 400061
010 083 400071

010 083 400062
010 083 400072

MUTLUSAN KAUCUK SANAYİ TIPI FİŞ - PRİZ GRUBU (TRİFAZE)

CE

Ürün Kodu	Ürün Adı	Kutu / Adet	Koli / Adet	Fiyat (₺)
010 083 400060	MUT-60 16A TRİFAZE ERKEK FİŞ	30	240	340,23
010 083 400061	MUT-61 16A TRİFAZE SEYYAR DIŞI FİŞ	25	200	416,21
010 083 400062	MUT-62 16A TRİFAZE DUVAR PRİZİ	20	160	521,68
010 083 400070	MUT-70 32A TRİFAZE ERKEK FİŞ	20	160	491,50
010 083 400071	MUT-71 32A TRİFAZE SEYYAR DIŞI FİŞ	15	120	560,08
010 083 400072	MUT-72 32A TRİFAZE DUVAR PRİZİ	20	160	737,25

SANAYİ TIPI FİŞ - PRİZLER

Ürün Kodu	Ürün Adı	Kutu Adet	Fiyat (₺)
019 107 016250	16/25A 4 KUTUPLU FİŞ-PRİZ	30	1.627,01
019 107 016252	16/25A 4 KUTUPLU PRİZ	45	861,39
019 107 016251	16/25A 4 KUTUPLU FİŞ	60	765,63
019 107 025400	25/40A 4 KUTUPLU FİŞ-PRİZ	15	2.089,79
019 107 025402	25/40A 4 KUTUPLU PRİZ	25	1.082,08
019 107 025401	25/40A 4 KUTUPLU FİŞ	35	1.007,71
019 107 040630	40/63A 4 KUTUPLU FİŞ-PRİZ	10	2.706,18
019 107 040632	40/63A 4 KUTUPLU PRİZ	15	1.391,74
019 107 040631	40/63A 4 KUTUPLU FİŞ	25	1.314,44
019 107 063100	63/100A 4 KUTUPLU FİŞ-PRİZ	5	4.301,11
019 107 063102	63/100A 4 KUTUPLU PRİZ	10	2.228,33
019 107 063101	63/100A 4 KUTUPLU FİŞ	15	2.072,78

SANAYİ TIPI SEYYAR PRİZLER

Ürün Kodu	Ürün Adı	Kutu Adet	Fiyat (₺)
019 107 016253	16/25A 4 KUTUPLU SEYYAR PRİZ	45	861,39
019 107 025403	25/40A 4 KUTUPLU SEYYAR PRİZ	25	1.082,08
019 107 040633	40/63A 4 KUTUPLU SEYYAR PRİZ	15	1.391,74
019 107 063103	63/100A 4 KUTUPLU SEYYAR PRİZ	10	2.228,33



TERMOPLASTİK BUATLAR (GRİ-BEYAZ)

Gri Kodu	Beyaz Kodu	Ürün Adı	Kutu Adet	Koli Adet	Gri Fiyat (₺)	Beyaz Fiyat (₺)
-	001 046 000101 00 00	85x85 KARE ANTİGRON BUAT	10	300		48,98
001 046 078080 00 17	001 046 078080 00 00	80x80x48 (7 ÇIKIŞLI) TERMOPLASTİK BUAT	18	108	78,35	83,25
001 046 078585 00 17	001 046 078585 00 00	85x85x48 TERMOPLASTİK BUAT	18	108	73,46	78,35
001 046 070090 00 17	001 046 070090 00 00	Ø90 TERMOPLASTİK BUAT	18	108	132,22	142,02
001 046 070110 00 17	001 046 070110 00 00	110x110x74 (8 ÇIKIŞ) TERMOPLASTİK BUAT - TIRNAKLI KAPAK	10	40	142,04	171,41
001 046 071010 00 17	001 046 071010 00 00	110x110x74 (8 ÇIKIŞ) TERMOPLASTİK BUAT	10	40	142,02	171,40
001 046 071118 00 17	001 046 071118 00 00	110x180x77 (10 ÇIKIŞ) TERMOPLASTİK BUAT	5	30	220,37	284,03
001 046 071827 00 17	001 046 071827 00 00	180x270x100 (14 ÇIKIŞ) TERMOPLASTİK BUAT	2	8	612,14	685,60

YENİ



001 046 072698 00 44



001 046 072698 00 17



001 046 076131 00 44



001 046 076131 00 17



001 046 078226 00 17

TERMOPLASTİK BUATLAR VE KOMBİNASYON KUTULARI

Ürün Kodu	Ürün Adı	Koli Adet	Fiyat (₺)
001 046 072698 00 44	138x226x98 TERMOPLASTİK BUAT (ŞEFFAF KAPAKLI)	8	576,13
001 046 072698 00 17	138x226x98 TERMOPLASTİK BUAT	8	504,12
001 046 076131 00 44	138x226x131 TERMOPLASTİK BUAT (ŞEFFAF KAPAKLI)	8	576,13
001 046 076131 00 17	138x226x131 TERMOPLASTİK BUAT	8	552,13
001 046 078226 00 17	138x226x127 KOMBİNASYON KUTUSU	8	624,14



001 046 071199 00 44



001 046 071199 00 17



001 046 071130 00 44



001 046 071130 00 17



001 046 075311 00 17

TERMOPLASTİK BUATLAR VE KOMBİNASYON KUTULARI

Ürün Kodu	Ürün Adı	Koli Adet	Fiyat (₺)
001 046 071199 00 44	225x311x99 TERMOPLASTİK BUAT (ŞEFFAF KAPAKLI)	4	888,21
001 046 071199 00 17	225x311x99 TERMOPLASTİK BUAT	4	720,17
001 046 071130 00 44	225x311x130 TERMOPLASTİK BUAT (ŞEFFAF KAPAKLI)	4	888,21
001 046 071130 00 17	225x311x130 TERMOPLASTİK BUAT	4	720,17
001 046 075311 00 17	225x311x132 KOMBİNASYON KUTUSU	4	1.008,23

YENİ



IP65



IP40

001 046 098080 00 17



IP40

001 046 098585 00 17



IP40

001 046 090090 00 17



IP65

001 046 091010 00 17



IP65

001 046 091118 00 17



IP65

001 046 091827 00 17

ALEV YAYMAYAN TERMOPLASTİK BUATLAR (GRİ-BEYAZ)



Grİ Kodu	BeYaz Kodu	Ürün Adı	Kutu Adet	Koli Adet	Grİ Fiyat (₺)	BeYaz Fiyat (₺)
001 046 098080 00 17	-	80x80x48 (7 ÇIKIŞLI) TERMOPLASTİK BUAT - ALEV YAYMAYAN	18	108	118,68	-
001 046 098585 00 17	001 046 098585 00 00	85x85x48 TERMOPLASTİK BUAT - ALEV YAYMAYAN	18	108	138,46	138,46
001 046 090090 00 17	001 046 090090 00 00	Ø90 TERMOPLASTİK BUAT - ALEV YAYMAYAN	18	108	128,58	128,58
001 046 090110 00 17	001 046 090110 00 00	110x110x74 (8 ÇIKIŞ) TERMOPLASTİK BUAT - TIRNAKLI KAPAK - A.YAYMAYAN	10	40	296,70	296,70
001 046 091010 00 17	001 046 091010 00 00	110x110x74 (8 ÇIKIŞ) TERMOPLASTİK BUAT - ALEV YAYMAYAN	10	40	296,70	296,70
001 046 091118 00 17	001 046 091118 00 00	110x180x77 (10 ÇIKIŞ) TERMOPLASTİK BUAT - ALEV YAYMAYAN	5	30	519,24	519,24
001 046 091827 00 17	001 046 091827 00 00	180x270x100 (14 ÇIKIŞ) TERMOPLASTİK BUAT - ALEV YAYMAYAN	2	8	1.137,38	1.137,38



IP65

001 046 092698 00 44



IP65

001 046 092698 00 17



IP65

001 046 096131 00 44



IP65

001 046 096131 00 17



IP65

001 046 098226 00 17

ALEV YAYMAYAN TERMOPLASTİK BUATLAR VE KOMBİNASYON KUTULARI

Ürün Kodu	Ürün Adı	Koli Adet	Fiyat (₺)
001 046 092698 00 44	138x226x98 TERMOPLASTİK BUAT (ŞEFFAF KAPAKLI) - ALEV YAYMAYAN	8	600,52
001 046 092698 00 17	138x226x98 TERMOPLASTİK BUAT - ALEV YAYMAYAN	8	640,23
001 046 096131 00 44	138x226x131 TERMOPLASTİK BUAT (ŞEFFAF KAPAKLI) - ALEV YAYMAYAN	8	647,03
001 046 096131 00 17	138x226x131 TERMOPLASTİK BUAT - ALEV YAYMAYAN	8	726,37
001 046 098226 00 17	138x226x127 KOMBİNASYON KUTUSU - ALEV YAYMAYAN	8	809,47



IP65

001 046 091199 00 44



IP65

001 046 091199 00 17



IP65

001 046 091130 00 44



IP65

001 046 091130 00 17



IP65

001 046 095311 00 17

ALEV YAYMAYAN TERMOPLASTİK BUATLAR VE KOMBİNASYON KUTULARI

Ürün Kodu	Ürün Adı	Koli Adet	Fiyat (₺)
001 046 091199 00 44	225x311x99 TERMOPLASTİK BUAT (ŞEFFAF KAPAKLI) - ALEV YAYMAYAN	4	1.031,64
001 046 091199 00 17	225x311x99 TERMOPLASTİK BUAT - ALEV YAYMAYAN	4	1.096,51
001 046 091130 00 44	225x311x130 TERMOPLASTİK BUAT (ŞEFFAF KAPAKLI) - ALEV YAYMAYAN	4	1.044,94
001 046 091130 00 17	225x311x130 TERMOPLASTİK BUAT - ALEV YAYMAYAN	4	1.185,83
001 046 095311 00 17	225x311x132 KOMBİNASYON KUTUSU - ALEV YAYMAYAN	4	1.333,33



010 104 000180



010 104 000181



010 104 000182



010 104 000183

KOMBİNASYON PANOLARI

Ürün Kodu	Ürün Adı	Koli Adet	Fiyat (₺)
010 104 000180	MK-325-2 3x25A 1 ADET ÖN + 1x16A 2 ADET YAN	4	1.269,44
010 104 000181	MK-516-1 5x16A 1 ADET ÖN + 1x16A 1 ADET YAN	6	962,52
010 104 000182	MK-516-2 5x16A 1 ADET ÖN + 1x16A 2 ADET YAN	4	1.538,78
010 104 000183	MK-532-1 5x32A 1 ADET ÖN + 1x16A 1 ADET YAN	6	1.089,68



010 104 000184



010 104 000185



010 104 000186



010 104 000187

Ürün Kodu	Ürün Adı	Koli Adet	Fiyat (₺)
010 104 000184	MK-532-2 5x32 A 1 ADET ÖN + 1x16A 2 ADET YAN	4	1.669,38
010 104 000185	MK-2325-2 3x25 A 2 ADET ÖN + 1x16A 2 ADET YAN	4	1.979,02
010 104 000186	MK-2516-2 5x16A 2 ADET ÖN + 1x16A 2 ADET YAN	4	2.517,06
010 104 000187	MK-2516-4 5x16 A 2 ADET ÖN + 1x16A 4 ADET YAN	4	2.855,41



010 104 000188



010 104 000189



010 104 000190



010 104 000191



010 104 000192

Ürün Kodu	Ürün Adı	Koli Adet	Fiyat (₺)
010 104 000188	MK-2532-2 5x32A 2 ADET ÖN + 1x16A 2 ADET YAN	4	2.773,38
010 104 000189	MK-2532-4 5x32A 2 ADET ÖN + 1x16A 4 ADET YAN	4	3.113,82
010 104 000190	MK-5164-4 5x16A 4 ADET ÖN + 1x16A 4 ADET YAN	3	4.699,14
010 104 000191	MK-5324-4 5x32A 4 ADET ÖN + 1x16A 4 ADET YAN	3	5.213,22
010 104 000192	MK-51632-4 5x16A 2 ADET ÖN + 5x32 A 2 ADET ÖN + 1x16A 4 ADET YAN	3	4.954,81



010 104 000120



010 104 000121



010 104 000122



010 104 000123



010 104 000124



010 104 000125



010 104 000126



010 104 000127



010 090 050009



010 104 000129



010 104 000130



010 104 000133

KUTU MONTAJLI ÜRÜNLER

Ürün Kodu	Ürün Adı	Koli Adet	Fiyat (₺)
010 104 000120	MS-KK31 1'Lİ KUTULU START BUTONU (1NO)	18	283,52
010 104 000121	MS-KK42 1'Lİ KUTULU STOP BUTONU (1NC)	18	283,52
010 104 000122	MS-KK51 1'Lİ KUTULU START BUTONU (1NO)	18	283,52
010 104 000123	MS-BX71 1'Lİ KUTULU ALARM BUTONU (1NO)	18	296,00
010 104 000124	MS-BX81 1'Lİ KUTULU AYDINLATMA BUTONU (1NO)	18	296,00
010 104 000125	MS-KK7325 1'Lİ KUTULU İKİZ BUTONU (1NO+1NC)	18	402,60
010 104 000126	MS-KK4151 1'Lİ KUTULU İŞARETLİ İKİZ BUTONU (1NO+1NO)	18	413,94
010 104 000127	MS-KBZ 1'Lİ KUTULU KABİN ALTI İKAZ LAMBASI BUZZERLİ	18	487,66
010 090 050009	MS-BX542 1'Lİ KUTULU ACİL STOP BUTONU (1NC)	18	340,23
010 104 000129	MS-BX542E 1'Lİ KUTULU EMERGENCY STOP BUTONU (1NC)	18	351,57
010 104 000130	MS-BX542ASP 1'Lİ KUTULU MÜHÜRLÜ TİP KORUMA ACİL STOP BUTONU (1NC)	12	612,41
010 104 000133	MS-KANT 1'Lİ KUTULU KAYICI RESET ANAHTARI	12	464,98

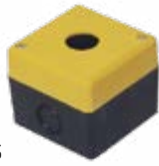

010 104 000105



010 104 000106



010 104 000107



010 104 000156

EKO SERİSİ KUMANDA KUTULARI

Ürün Kodu	Ürün Adı	Koli Adet	Fiyat (₺)
010 104 000105	EKO101S EKO 1'Lİ BOŞ KUMANDA KUTUSU	90	61,82
010 104 000106	EKO201S EKO 1'Lİ KORUMALI BOŞ KUMANDA KUTUSU	50	67,65
010 104 000107	EKO301S EKO 1'Lİ ACİL STOP ETİKETLİ YAZILI KUMANDA KUTUSU	50	267,90
010 104 000156	EKO401S EKO 1'Lİ ACİL STOPLU KUMANDA KUTUSU	50	261,03



010 091 01XX01



010 091 01XX02



010 091 01XX03



010 091 01XX04



010 104 000114



010 104 000115



010 104 000116



010 104 000117

BOŞ KUMANDA KUTULARI

XX yerine Gri için 00, Sarı için 14 rakamını yazınız.

Ürün Kodu	Ürün Adı	Koli Adet	Fiyat (₺)
010 091 01XX01	1'Lİ ETANJ BUTON KUTUSU EUROBOX	24	121,10
010 091 01XX02	2'Lİ ETANJ BUTON KUTUSU EUROBOX	18	152,01
010 091 01XX03	3'LÜ ETANJ BUTON KUTUSU EUROBOX	12	203,67
010 091 01XX04	4'LÜ ETANJ BUTON KUTUSU EUROBOX	10	236,99
010 104 000114	SW-BX055B 5'Lİ ETANJ BUTON KUTUSU EUROBOX	8	314,56
010 104 000115	SW-BX065B 6'Lİ ETANJ BUTON KUTUSU EUROBOX	8	346,76
010 104 000116	SW-BX075B 7'Lİ ETANJ BUTON KUTUSU EUROBOX	6	366,57
010 104 000117	SW-BX085B 8'Lİ ETANJ BUTON KUTUSU EUROBOX	6	391,34

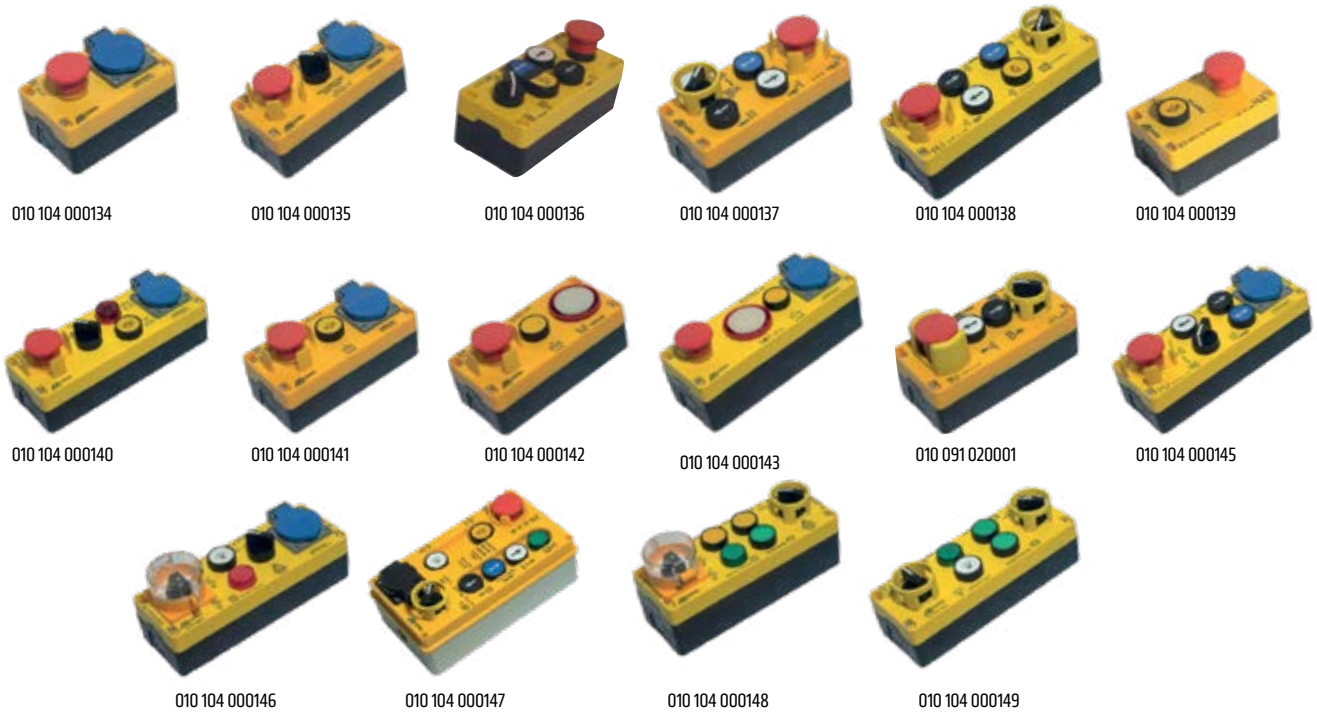

ASANSÖR KUYU DİBİ SETLERİ VE KUMANDALARI

Ürün Kodu	Ürün Adı	Koli Adet	Fiyat (₺)
010 104 000134	MS-KYD02 2'Lİ ASANSÖR KUYU DİBİ BUTON 220V 16A TOPRAKLAMALI PRİZ + ACİL STOP BUTON	9	592,05
010 104 000135	MS-KYD03 ACİL STOP BUTON + SEÇİCİ BUTON (2NO) 220V 16A TOPRAKLAMALI PANO PRİZİ	6	899,69
010 104 000136	MS-KYD04 6'Lİ ACİL STOP BUTON + 2 ADET OKLU BUTON (1NO) 1 İKİZ BUTON (2NO) 1 SEÇİCİ BUTON (2NO)	5	1.474,32
010 104 000137	MS-KYD05 ACİL STOP BUTON + 2 OKLU BUTON ORTAK OKLU (1NO) SEÇİCİ BUTON (2NO-1NC)	4	1.358,23
010 104 000138	MS-KYD06 ACİL STOP BUTON + 2 OKLU BUTON (2NO)1 ORTAK BUTON (1NO) ALARM BUTONU +SEÇİCİ BUTON (2NO-1NC)	2	1.474,32
010 104 000139	KY2-ALR KORUMALI ACİL STOP BUTON (1NC)NO KONTAKLI ALARM BUTONU KOMBİNASYON	10	592,05
010 104 000140	MS-KY5-24 KORUMALI ACİL STOP BUTON (1NC)LAMBA VAVİEN (1NO)24V KATTA LED (1NO) ALARM BUTON 16A KAPAKLI PRİZ	4	1.543,98
010 104 000141	MS-KY3 KORUMALI ACİL STOP BUTON + ALARM BUTON +16A KAPAKLI PRİZ KOMBİNASYON	5	859,05
010 104 000142	MS-KY3ES5012 KORUMALI ACİL STOP BUTON + ALARM + 9V PİLLİ 130 dB KOMBİNASYON	5	1.393,06
010 104 000143	MS-KY4ES5012 KORUMALI ACİL STOP BUTON + 9V PİLLİ 130 dB ALARM + 16A KAPAKLI PRİZ KOMBİNASYON	4	1.543,98
010 091 020001	MS-LV4 YUKARI (1NO) AŞAĞI (1NO) 0-1 REVİZYON (1NO) ACİL STOP BUTON (1NC) EL TERMİNALİ (EL KUMANDA)	6	1.091,23
010 104 000145	MS-LV5 YUKARI (1NO) ORTAK (1NO) AŞAĞI (1NO) 0-1 REVİZYON (1NO) ACİL STOP BUTON (1NC) 16A KAPAKLI PRİZ EL TERMİNALİ	4	1.543,98
010 104 000146	MS3BY-BG53P 3KADEME BY-PASSLI LAMBA BUTON (1NO) 24V KATTA LEDLİ REG.AÇMA (1NO) 16A KAPAKLI PRİZ KOMBİN.	4	2.112,81
010 104 000147	MS9-BX07 YUKARI (1NO) AŞAĞI (1NO) ORTAK (1NO) 24V KATTA LEDLİ KOR. ACİL STOP(1NC) ALARM (1NO) LAMBA (1NO)KOR. 0-1REV.(1NO)16A	1	2.275,33
010 104 000148	MS102-ED21 3BY 3KADEME BY-PASSLI REG.KİLİT (1NO) REG.AÇ(1NO) 24V KATTA LED FREN AÇMA (1NO) KOR.0-1SET RESET (1NO)	4	2.344,99
010 104 000149	MS201-ED21 REG.AÇ KAPA (2NO)24V KATTA LED LAMBA BUTON (1NO) FREN AÇMA1 (1NO) FREN AÇMA2(1NO) KORUMA SET RESET (2NO)	4	1.567,19



VİNÇ KUTULARI

Ürün Kodu	Ürün Adı	Kutu Adet	Fiyat (₺)
010 092 000001	İKİLİ VİNÇ KUTUSU - TEK HIZLI	1	1.559,38
010 092 000002	ÜÇLÜ VİNÇ KUTUSU - TEK HIZLI	1	1.778,47
010 092 000003	DÖRTLÜ VİNÇ KUTUSU - TEK HIZLI	1	2.010,44
010 092 000004	BEŞLİ VİNÇ KUTUSU - TEK HIZLI	1	2.233,82
010 092 000005	ALTILI VİNÇ KUTUSU - TEK HIZLI	1	2.723,54
010 092 000006	YEDİLİ VİNÇ KUTUSU - TEK HIZLI	1	2.946,93



010 104 000003



010 104 000004



010 104 000005



010 104 000006



010 104 000007



010 104 000008

SWISS SERİSİ PLASTİK YAYLI BUTONLAR

Ürün Kodu	Ürün Adı	Kutu Adet	Fiyat (₺)
010 104 000003	SW-AA42 22 mm PLASTİK YAYLI BUTON - STOP	10	123,05
010 104 000004	SW-AA31 22 mm PLASTİK YAYLI BUTON - START	10	123,05
010 104 000005	SW-AA51 22 mm PLASTİK YAYLI BUTON - START	10	123,05
010 104 000006	SW-AA61 22 mm PLASTİK YAYLI BUTON - START	10	123,05
010 104 000007	SW-AA21 22 mm PLASTİK YAYLI BUTON - START	10	123,05
010 104 000008	SW-AA11 22 mm PLASTİK YAYLI BUTON - START	10	123,05



010 104 000009



010 104 000010



010 104 000011



010 104 000012



010 104 000013



010 104 000014

SWISS SERİSİ PLASTİK YAYLI BUTONLAR

Ürün Kodu	Ürün Adı	Kutu Adet	Fiyat (₺)
010 104 000009	SW-AA4322 22 mm PLASTİK YAYLI BUTON - STOP	10	129,28
010 104 000010	SW-AA3361 22 mm PLASTİK YAYLI BUTON - START	10	129,28
010 104 000011	SW-AA3351 22 mm PLASTİK YAYLI BUTON - START	10	129,28
010 104 000012	SW-AA3341 22 mm PLASTİK YAYLI BUTON - START	10	129,28
010 104 000013	SW-AA3371 22 mm PLASTİK YAYLI BUTON - START	10	129,28
010 104 000014	SW-AA3381 22 mm PLASTİK YAYLI BUTON - START	10	129,28



010 104 000015



010 104 000016



010 104 000017



010 104 000018



010 104 000019



010 104 000020



010 104 000021



010 104 000022



010 104 000023



010 104 000024

SWISS SERİSİ PLASTİK YAYLI İKİZ BUTONLAR

Ürün Kodu	Ürün Adı	Kutu Adet	Fiyat (₺)
010 104 000015	SW-AL7325 22 mm PLASTİK İKİZ BUTON (1NO+1NC)	10	252,40
010 104 000016	SW-AL7181 22 mm PLASTİK ALARM - LAMBA İKİZ BUTON (1NO+1NO)	10	277,91
010 104 000017	SW-AL4252 22 mm PLASTİK YUKARI AŞAĞI OKLU TERS YÖNLÜ İKİZ BUTON (1NO+1NO)	10	277,91
010 104 000018	SW-AL6171 22 mm PLASTİK ALARM ORTAK OKLU İKİZ BUTON (1NO+1NO)	10	277,91
010 104 000019	SW-AL6181 22 mm PLASTİK LAMBA ORTAK OKLU İKİZ BUTON (1NO+1NO)	10	277,91
010 104 000020	SW-AL7425 22 mm PLASTİK İŞARETLİ İKİZ BUTON (1NO+1NC)	10	277,91
010 104 000021	SW-AL7525 22 mm PLASTİK YAZILI İKİZ BUTON (1NO+1NC)	10	277,91
010 104 000022	SW-AL4151 22 mm PLASTİK YUKARI AŞAĞI OKLU BUTON (1NO+1NO)	10	277,91
010 104 000023	SW-AL7465L 22 mm PLASTİK İKİZ BUTON (1NO+1NC) LEDLİ 220V AC/DC	10	467,43
010 104 000024	SW-AL7465-24L 22 mm PLASTİK İKİZ BUTON (1NO+1NC) LEDLİ 24V AC/DC	10	467,43



010 104 000025



010 104 000026



010 104 000027



010 104 000028

SWISS SERİSİ PLASTİK KALICI VE KAYICI MANDAL BUTONLAR

Ürün Kodu	Ürün Adı	Kutu Adet	Fiyat (₺)
010 104 000025	SW-AD21 PLASTİK KALICI 0 - 1 MANDAL BUTON (1NO)	10	145,11
010 104 000026	SW-AD41 PLASTİK KAYICI 0 - 1 MANDAL BUTON (1NO)	10	164,46
010 104 000027	SW-AD33 PLASTİK KALICI 2 - 0 - 1 MANDAL BUTON (1NO+1NO)	10	211,07
010 104 000028	SW-AD53 PLASTİK KAYICI 2 - 0 - 1 MANDAL BUTON (1NO+1NO)	10	228,66



010 104 000029



010 104 000030



010 104 000031



010 104 000032

SWISS SERİSİ PLASTİK ANAHTARLI KALICI VE KAYICI MANDAL BUTONLAR

Ürün Kodu	Ürün Adı	Kutu Adet	Fiyat (₺)
010 104 000029	SW-AG21 PLASTİK KALICI 0 - 1 ANAHTARLI MANDAL BUTON (1NO)	10	385,20
010 104 000030	SW-AG41 PLASTİK KAYICI 0 - 1 ANAHTARLI MANDAL BUTON (1NO)	10	385,20
010 104 000031	SW-AG33 PLASTİK KALICI 2 - 0 - 1 ANAHTARLI MANDAL BUTON (1NO+1NO)	10	452,92
010 104 000032	SW-AG53 PLASTİK KAYICI 2 - 0 - 1 ANAHTARLI MANDAL BUTON (1NO+1NO)	10	452,92



010 104 000037



010 104 000038



010 104 000039

SWISS SERİSİ PLASTİK KAYICI MANTAR BUTONLAR

Ürün Kodu	Ürün Adı	Kutu Adet	Fiyat (₺)
010 104 000037	SW-AC42 40 mm KAFA PLASTİK KAYICI MANTAR BUTON (1NC)	10	164,86
010 104 000038	SW-AC31 40 mm KAFA PLASTİK KAYICI MANTAR BUTON (1NO)	10	164,86
010 104 000039	SW-AC51 40 mm KAFA PLASTİK KAYICI MANTAR BUTON (1NO)	10	164,86



010 104 000033



010 104 000034



010 104 000035



010 104 000036

SWISS SERİSİ PLASTİK MANTAR ACİL STOP BUTONLAR

Ürün Kodu	Ürün Adı	Kutu Adet	Fiyat (₺)
010 104 000033	SW-AS142 40 mm KAFA PLASTİK ANAHTARLI MANTAR BUTON (1NC) ACİL STOP	10	439,73
010 104 000034	SW-AS542E 40 mm KAFA PLASTİK MANTAR BUTON (1NC) ACİL STOP ETİKETLİ	10	206,07
010 104 000035	SW-AS542 40 mm KAFA PLASTİK MANTAR BUTON (1NC) ACİL STOP	10	184,69
010 104 000036	SW-AS442 30 mm KAFA PLASTİK MANTAR BUTON (1NC) ACİL STOP	10	184,69



010 104 000040
010 104 000041



010 104 000042
010 104 000043



010 104 000044
010 104 000045



010 104 000046
010 104 000047

SWISS SERİSİ PLASTİK LEDLİ, İŞIKLI, YAYLI BUTONLAR

Ürün Kodu	Ürün Adı	Kutu Adet	Fiyat (₺)
010 104 000040	SW-AW3475 22 mm LEDLİ İŞIKLI YAYLI BUTON STOP - 110-240V AC	10	360,58
010 104 000041	SW-AW3475 22 mm LEDLİ İŞIKLI YAYLI BUTON STOP - 10-30V DC	10	360,58
010 104 000042	SW-AW3375 22 mm LEDLİ İŞIKLI YAYLI BUTON START - 110-240V AC	10	360,58
010 104 000043	SW-AW3375-24 22 mm LEDLİ İŞIKLI YAYLI BUTON START - 10-30V DC	10	360,58
010 104 000044	SW-AW3575 22 mm LEDLİ İŞIKLI YAYLI BUTON START - 110-240V AC	10	360,58
010 104 000045	SW-AW3575-24 22 mm LEDLİ İŞIKLI YAYLI BUTON START - 10-30V DC	10	360,58
010 104 000046	SW-AW3675 22 mm LEDLİ İŞIKLI YAYLI BUTON START - 110-240V AC	10	360,58
010 104 000047	SW-AW3675-24 22 mm LEDLİ İŞIKLI YAYLI BUTON START - 10-30V DC	10	360,58



010 104 000054
010 104 000057



010 104 000055
010 104 000058



010 104 000056
010 104 000059

SWISS SERİSİ 1-0-2 PLASTİK LEDLİ, İŞIKLI KALICI MANDAL BUTONLAR

Ürün Kodu	Ürün Adı	Kutu Adet	Fiyat (₺)
010 104 000054	SW-AK323L 1-0-2 PLASTİK LEDLİ KALICI MANDAL BUTON (2NO) 110-240V AC	10	451,58
010 104 000055	SW-AK324L 1-0-2 PLASTİK LEDLİ KALICI MANDAL BUTON (2NC) 110-240V AC	10	451,58
010 104 000056	SW-AK325L 1-0-2 PLASTİK LEDLİ KALICI MANDAL BUTON (2NO) 110-240V AC	10	451,58
010 104 000057	SW-AK323-24L 1-0-2 PLASTİK LEDLİ KALICI MANDAL BUTON (2NO) 10-24V AC/DC	10	451,58
010 104 000058	SW-AK324-24L 1-0-2 PLASTİK LEDLİ KALICI MANDAL BUTON (2NC) 10-24V AC/DC	10	451,58
010 104 000059	SW-AK325-24L 1-0-2 PLASTİK LEDLİ KALICI MANDAL BUTON (2NO) 10-24V AC/DC	10	451,58



010 104 000048
010 104 000051



010 104 000049
010 104 000052



010 104 000050
010 104 000053

SWISS SERİSİ 0-1 PLASTİK LEDLİ, İŞIKLI KALICI MANDAL BUTONLAR

Ürün Kodu	Ürün Adı	Kutu Adet	Fiyat (₺)
010 104 000048	SW-AK123L 0-1 PLASTİK LEDLİ KALICI MANDAL BUTON (1NO) 110-240V AC	10	382,56
010 104 000049	SW-AK124L 0-1 PLASTİK LEDLİ KALICI MANDAL BUTON (1NC) 110-240V AC	10	382,56
010 104 000050	SW-AK125L 0-1 PLASTİK LEDLİ KALICI MANDAL BUTON (1NO) 110-240V AC	10	382,56
010 104 000051	SW-AK123-24L 0-1 PLASTİK LEDLİ KALICI MANDAL BUTON (1NO) 10-24V AC/DC	10	382,56
010 104 000052	SW-AK124-24L 0-1 PLASTİK LEDLİ KALICI MANDAL BUTON (1NC) 10-24V AC/DC	10	382,56
010 104 000053	SW-AK125-24L 0-1 PLASTİK LEDLİ KALICI MANDAL BUTON (1NO) 10-24V AC/DC	10	382,56



010 104 000001



010 104 000002

POTANSİYOMETRE

Ürün Kodu	Ürün Adı	Kutu Adet	Fiyat (₺)
010 104 000001	MS22-5K POTANS 5K	15	669,74
010 104 000002	MS22-10K POTANS 10K	15	669,74



010 104 000064

010 104 000065

010 104 000066

010 104 000067

010 104 000068

010 104 000069

SWISS SERİSİ METAL KAPLAMALI YAYLI BUTONLAR

Ürün Kodu	Ürün Adı	Kutu Adet	Fiyat (₺)
010 104 000064	SW-BA42 22 mm YAYLI BUTON STOP (1NC)	10	136,32
010 104 000065	SW-BA31 22 mm YAYLI BUTON START (1NO)	10	136,32
010 104 000066	SW-BA51 22 mm YAYLI BUTON START (1NO)	10	136,32
010 104 000067	SW-BA11 22 mm YAYLI BUTON START (1NO)	10	136,32
010 104 000068	SW-BA61 22 mm YAYLI BUTON START (1NO)	10	136,32
010 104 000069	SW-BA21 22 mm YAYLI BUTON START (1NO)	10	136,32



010 104 000071

010 104 000072

010 104 000073

010 104 000074

010 104 000075

010 104 000076

SWISS SERİSİ METAL KAPLAMALI İŞARETLİ YAYLI BUTONLAR

Ürün Kodu	Ürün Adı	Kutu Adet	Fiyat (₺)
010 104 000071	SW-BA4322 22 mm İŞARETLİ YAYLI BUTON STOP (1NC)	10	148,59
010 104 000072	SW-BA3351 22 mm İŞARETLİ YAYLI BUTON START (1NO)	10	148,59
010 104 000073	SW-BA3341 22 mm İŞARETLİ YAYLI BUTON START (1NO)	10	148,59
010 104 000074	SW-BA3361 22 mm İŞARETLİ YAYLI BUTON START (1NO)	10	148,59
010 104 000075	SW-BA3371 22 mm İŞARETLİ YAYLI BUTON START (1NO)	10	148,59
010 104 000076	SW-BA3381 22 mm İŞARETLİ YAYLI BUTON START (1NO)	10	148,59



010 104 000077

010 104 000078

010 104 000079

SWISS SERİSİ METAL KAPLAMALI İKİZ BUTONLAR

Ürün Kodu	Ürün Adı	Kutu Adet	Fiyat (₺)
010 104 000077	SW-BL7325 22 mm PLASTİK İKİZ BUTON (1NO+1NC)	10	277,03
010 104 000078	SW-BL7425 22 mm PLASTİK İKİZ BUTON (1NO+1NC)	10	306,47
010 104 000079	SW-BL7525 22 mm PLASTİK YAZILI İKİZ BUTON (1NO+1NC)	10	306,47



010 104 000080

010 104 000081

010 104 000082

010 104 000083

010 104 000084

010 104 000085

010 104 000086

SWISS SERİSİ METAL KAPLAMALI İKİZ BUTONLAR

Ürün Kodu	Ürün Adı	Kutu Adet	Fiyat (₺)
010 104 000080	SW-BL4151 22 mm PLASTİK YUKARI AŞAĞI OKLU İKİZ BUTON (1NO+1NO)	10	306,47
010 104 000081	SW-BL4252 22 mm PLASTİK YUKARI AŞAĞI TERS YÖN OKLU İKİZ BUTON (1NO+1NO)	10	306,47
010 104 000082	SW-BL6171 22 mm PLASTİK ALARM ORTAK OKLU İKİZ BUTON (1NO+1NO)	10	306,47
010 104 000083	SW-BL7181 22 mm PLASTİK ALARM - LAMBA İKİZ BUTON (1NO+1NO)	10	306,47
010 104 000084	SW-BL6181 22 mm PLASTİK LAMBA ORTAK OKLU İKİZ BUTON (1NO+1NO)	10	306,47
010 104 000085	SW-BL7465L 22 mm PLASTİK İKİZ BUTON LEDLİ (220V AC)	10	514,48
010 104 000086	SW-BL7465L-24L 22 mm PLASTİK İKİZ BUTON LEDLİ (24V AC/DC)	10	514,48



010 104 000087



010 104 000088



010 104 000089



010 104 000090

SWISS SERİSİ METAL KAPLAMALI KALICI VE KAYICI MANDAL BUTONLAR

Ürün Kodu	Ürün Adı	Kutu Adet	Fiyat (₺)
010 104 000087	SW-BD21 0-1 KALICI MANDAL BUTON (1NO)	10	159,62
010 104 000088	SW-BD41 0-1 KAYICI MANDAL BUTON (1NO)	10	180,29
010 104 000089	SW-BD33 1-0-2 KALICI MANDAL BUTON (1NO+1NO)	10	233,06
010 104 000090	SW-BD53 1-0-2 KAYICI MANDAL BUTON (1NO+1NO)	10	255,04



010 104 000168



010 104 000169



010 104 000170



010 104 000171



010 104 000172



010 104 000173

SWISS SERİSİ METAL KAPLAMALI 0-1 LEDLİ KALICI BUTONLAR

Ürün Kodu	Ürün Adı	Kutu Adet	Fiyat (₺)
010 104 000168	SW-BK123L 0-1 LEDLİ IŞIKLI KALICI MANDAL BUTON (1NO) 110-240V AC	10	394,88
010 104 000169	SW-BK124L 0-1 LEDLİ IŞIKLI KALICI MANDAL BUTON (1NC) 110-240V AC	10	394,88
010 104 000170	SW-BK125L 0-1 LEDLİ IŞIKLI KALICI MANDAL BUTON (1NO) 110-240V AC	10	394,88
010 104 000171	SW-BK123L-24L 0-1 LEDLİ IŞIKLI KALICI MANDAL BUTON (1NO) 10-30V AC/DC	10	394,88
010 104 000172	SW-BK124L-24L 0-1 LEDLİ IŞIKLI KALICI MANDAL BUTON (1NC) 10-30V AC/DC	10	394,88
010 104 000173	SW-BK125L-24L 0-1 LEDLİ IŞIKLI KALICI MANDAL BUTON (1NC) 10-30V AC/DC	10	394,88



010 104 000160



010 104 000162



010 104 000164



010 104 000166



010 104 000161



010 104 000163



010 104 000165



010 104 000167

SWISS SERİSİ METAL KAPLAMALI LEDLİ İŞIKLI YAYLI BUTONLAR

Ürün Kodu	Ürün Adı	Kutu Adet	Fiyat (₺)
010 104 000160	BW-3475 22 mm LEDLİ İŞIKLI YAYLI BUTON STOP 110-240V AC	10	369,37
010 104 000161	BW-3475-24L 22 mm LEDLİ İŞIKLI YAYLI BUTON STOP 10-30V AC/DC	10	369,37
010 104 000162	BW-3375 22 mm LEDLİ İŞIKLI YAYLI BUTON START 110-240V AC	10	369,37
010 104 000163	BW-3375-24L 22 mm LEDLİ İŞIKLI YAYLI BUTON START 10-30V AC/DC	10	369,37
010 104 000164	BW-3575 22 mm LEDLİ İŞIKLI YAYLI BUTON START 110-240V AC	10	369,37
010 104 000165	BW-3575-24L 22 mm LEDLİ İŞIKLI YAYLI BUTON START 10-30V AC/DC	10	369,37
010 104 000166	BW-3675 22 mm LEDLİ İŞIKLI YAYLI BUTON START 110-240V AC	10	369,37
010 104 000167	BW-3675-24L 22 mm LEDLİ İŞIKLI YAYLI BUTON START 10-30V AC/DC	10	369,37



010 104 000174



010 104 000175



010 104 000176



010 104 000177



010 104 000178



010 104 000179

SWISS SERİSİ METAL KAPLAMALI 0-1-2 LEDLİ KALICI MANDAL BUTONLAR

Ürün Kodu	Ürün Adı	Kutu Adet	Fiyat (₺)
010 104 000174	BK-323L 1-0-2 PLASTİK LEDLİ KALICI MANDAL BUTON (2NO) 110-240V AC	10	460,87
010 104 000175	BK-324L 1-0-2 PLASTİK LEDLİ KALICI MANDAL BUTON (2NC) 110-240V AC	10	460,87
010 104 000176	BK-325L 1-0-2 PLASTİK LEDLİ KALICI MANDAL BUTON (2NO) 110-240V AC	10	460,87
010 104 000177	BK-323-24L 1-0-2 PLASTİK LEDLİ KALICI MANDAL BUTON (2NO) 10-24V AC/DC	10	460,87
010 104 000178	BK-324-24L 1-0-2 PLASTİK LEDLİ KALICI MANDAL BUTON (2NC) 10-24V AC/DC	10	460,87
010 104 000179	BK-325-24L 1-0-2 PLASTİK LEDLİ KALICI MANDAL BUTON (2NO) 10-24V AC/DC	10	460,87



010 104 000060



010 104 000061



010 104 000062

YAYLI BUTON YEDEK KONTAKLARI VE KILIFI

Ürün Kodu	Ürün Adı	Kutu Adet	Fiyat (₺)
010 104 000060	SW-BE101 KONTAK BLOK (NO)	50	68,60
010 104 000061	SW-BE102 KONTAK BLOK (NC)	50	68,60
010 104 000062	SW-BE103 İŞIK SOKETİ 10/30 110-240V AC	50	237,45



010 104 000091



010 104 000092



010 104 000093



010 093 000002



010 093 000001



010 093 000099

BUTON AKSESUARLARI

Ürün Kodu	Ürün Adı	Kutu Adet	Fiyat (₺)
010 104 000091	SW-BR1 PLASTİK BUTON ROZETİ 26x8 CAMLI	100	46,61
010 104 000092	SW-BR2 PLASTİK BUTON ROZETİ 26x18 CAMLI	100	52,77
010 104 000093	SW-SİE-R PLASTİK BUTON ROZETİ 27x12 CAMSIZ	100	41,33
010 093 000002	SW-BRY PLASTİK YAZILI BUTON ROZETİ	100	25,50
010 093 000001	SW-AP2 BUTON KORUMA KILIFI (YAYLI BUTONLAR İÇİN)	50	51,85
010 104 000099	SW-AP4 IP67 İKİZ BUTON KORUMA KILIFI (YAYLI BUTONLAR İÇİN)	50	51,85



010 104 000213



010 104 000214
010 104 000215
010 104 000216
010 104 000217



010 090 050008



010 104 000101



010 104 000096



010 093 000003



010 104 000104

ACİL STOP ETİKETLERİ

Ürün Kodu	Ürün Adı	Kutu Adet	Fiyat (₺)
010 104 000213	SW-ASP TAM KAPAKLI MÜHÜRLÜ ACİL STOK KORUMA KAPAĞI	10	103,04
010 104 000214	SW-SY60L SÜREKLİ YANAR LEDLİ ETİKET 220V	25	592,46
010 104 000215	SW-SY60-24 SÜREKLİ YANAR LEDLİ ETİKET 24V	25	592,46
010 104 000216	SW-FY60L FLAŞ YANAR LEDLİ ETİKET 220V	25	592,46
010 104 000217	SW-FY60L-24 FLAŞ YANAR LEDLİ ETİKET 24V	25	592,46
010 104 000096	SW-ER60EN-Y Ø60 mm PLASTİK EMERGENCY ROZETİ (İNCE TİP) LAZER BASKI	50	43,97
010 093 000003	ACİL DURDURMA ETİKETİ	50	41,33
010 090 050008	SW-AKKM EMNİYET BASMA DÜĞMESİ MUHAFAZA	50	36,84
010 104 000101	SW-AKK ACİL STOP KORUMA KAPAĞI	50	51,00
010 104 000104	SW-MKKY MANDAL BUTON KORUMA KAPAĞI	50	42,50



999 999 995000



999 999 995001



999 999 995002



VOLTMETRE VE AMPERMETRE

Ürün Kodu	Ürün Adı	Kutu Adet	Fiyat (₺)
999 999 995000	22 mm VOLTMETRE PLASTİK LED GÖSTERGELİ 20-500V AC	10	334,87
999 999 995001	22 mm AMPERMETRE (AKIM TRAFOLU) PLASTİK LED GÖSTERGE 1A-100A AC / 60-380V AC	10	669,74
999 999 995002	22 mm VOLT + AMPERMETRE (AKIM TRAFOLU) PLASTİK LED GÖSTERGE 20-500V AC / 1A-100A AC	10	839,75



010 090 01XX01

010 090 01XX05
010 090 01XX06
010 090 01XX07



010 090 01XX04
010 090 07XX02



010 111 070001
010 111 070002



XX KARŞILIĞI OLAN RENK KODLARI

○	●	●	●	●
Beyaz	Mavi	Sarı	Yeşil	Kırmızı
00	13	14	15	16

MUTLUSAN SİNYAL VE KUMANDA BUTONLARI

Ürün Kodu	Ürün Adı	Kutu Adet	Fiyat (₺)
010 090 01XX01	10 mm KABLOLU SİNYAL ARMATÜRÜ	100	34,00
010 090 01XX05	14 mm SİNYAL ARMATÜRÜ - 12V	50	47,49
010 090 01XX06	14 mm SİNYAL ARMATÜRÜ - 24V	50	47,49
010 090 01XX07	14 mm SİNYAL ARMATÜRÜ - 220V	50	47,49
010 090 01XX04	22 mm SİNYAL ARMATÜRÜ LEDLİ - 220V	24	72,13
010 090 07XX02	22 mm SİNYAL ARMATÜRÜ LEDLİ - 24V	24	69,65
010 111 070001	BUZZER LEDLİ - 220V	24	257,59
010 111 070002	BUZZER LEDLİ - 24V	24	257,59

Hayat Kurtaran Detaylar...



Otomatik Sigorta, Kaçak Akım Devre Kesici ve Kompakt Tip Devre Kesiciler için güvenli enerji izolasyonu.

Bakım ve onarım çalışmalarında istenmeyen enerjilendirmeyi önlemek amacıyla tasarlanan emniyet kilitleri;

Otomatik Sigorta (MCB), Kaçak Akım Devre Kesici (RCCB) ve Kompakt Tip Devre Kesiciler (MCCB) şalterlerle uyumludur. Şalteri kapalı (OFF) konumda sabitleyerek yetkisiz müdahaleleri engeller ve maksimum iş güvenliği sağlar.

Dayanıklı gövde yapısı ve standart güvenlik kilitleriyle uyumlu tasarımı sayesinde endüstriyel tesislerden şantiyelere kadar geniş kullanım alanı sunar.

- Güvenli enerji izolasyonu
- Yetkisiz müdahaleye karşı koruma
- Kolay montaj, sağlam yapı
- MCB / RCCB / MCCB uyumlu çözümler



Mutlusan Plastik Elektrik San ve Tic. A.Ş.

İkitelli Org.San. Bölgesi Mahallesi Enkoop Cad.
No:7 Başakşehir- İstanbul
Tel : +90 (212) 485 05 44 (PBX)
Faks : +90 (212) 485 10 12

Karaköy Şube

Okçumusa Cad. Güneşhan İş Hanı No : 24/10
Karaköy- İstanbul
Tel : +90 (212) 237 06 02 (PBX)
Fax: +90 (212) 237 77 47

Perpa Şube

Perpa Tic. Merkezi A Blok Kat: 2
No: 9-009 Okmeydanı - İstanbul
Tel : +90 (212) 320 05 78 (PBX)
Fax: +90 (212) 320 05 81

mutlusan.com.tr

